



SPANISH CAPACITIES IN LARGE SCIENTIFIC FACILITIES



The information included in this publication has been provided directly by the companies themselves and checked whenever possible by CDTI. CDTI shall not be held liable for the accuracy or truthfulness of this information or the damages its use may cause. For more information, the companies may be contacted directly.

The catalogue includes companies with capacity to deliver technology to Large Research Infrastructures, but there may be others with similar expertise. For more information, you can contact CDTI.

© CDTI - Regardless of the purpose, total or partial reproduction, exploitation, distribution and marketing of the information within this document requires the citation of the source and the prior consent of CDTI.

Publication included in the 2022 editorial program of the Ministry of Science and Innovation
General catalogue of official publications: <https://cpage.mpr.gob.es>

Edited by: CDTI, E.P.E.

c/ Cid, 4 – 28001 Madrid (Spain)

NIPO: 838220037

e-NIPO: 838220042

Legal deposit: M-20616-2022

Index

Foreword.....	1
CDTI.....	2
IFMIF-DONES.....	4
INDUCIENCIA.....	6
<u>SPANISH COMPANIES</u>	
ABENGOA.....	10
AERNNOVA AEROSPACE.....	12
AIMEN TECHNOLOGY CENTRE.....	14
AIRBUS DEFENCE AND SPACE.....	16
AIRTIFICIAL.....	18
ALIBAVA SYSTEMS.....	20
ALTER TECHNOLOGY TUV NORD.....	22
ANTEC MAGNETS.....	24
APPLUS+ LABORATORIES (LGA Technological Center).....	26
ARCECLIMA.....	28
ARQUIMEA.....	30
ARRAELA.....	32
ASE OPTICS EUROPE.....	34
ASTURFEITO.....	36
ATS GLOBAL.....	38
AVANCEM.....	40
AVS - ADDED VALUE INDUSTRIAL ENGINEERING SOLUTIONS.....	42
AWGE TECHNOLOGIES.....	44
BTC IBÉRICA.....	46
BTESA - BROAS TELECOM.....	48
BURDINBERRI.....	50
CADINOX.....	52
CAP GEMINI ENGINEERING.....	54
CBRE GWS.....	56
CEIT.....	58
CEN SOLUTIONS.....	60
CITD ENGINEERING & TECHNOLOGIES.....	62
COMET INGENIERÍA.....	64
CRISA.....	66
CT ENGINEERING.....	68
D+T MICROELECTRÓNICA.....	70
DAS PHOTONICS.....	72
DEIMOS SPACE.....	74
DRAGADOS.....	76
EGILE MECHANICS.....	78
EIIT.....	80
ELYTT ENERGY.....	82
EMPRESARIOS AGRUPADOS INTERNACIONAL.....	84
EMBEDDED INSTRUMENTS AND SYSTEMS.....	86
ENSA - EQUIPOS NUCLEARES.....	88
EOSOL GROUP.....	90
ESTEYCO.....	92
FAGOR AUTOMATION.....	94
FERROVIAL.....	96
FRACTAL.....	98
FUS_ALIANZ® SCIENCE, ENGINEERING AND CONSULTING.....	100
FYLA.....	102
GDES.....	104
GMV.....	106
GREENLIGHT SOLUTIONS.....	108
GTD SISTEMAS DE INFORMACIÓN.....	110
GUTMAR.....	112
HILFA.....	114
IBERDROLA GENERACIÓN.....	116
IDESA.....	118
IDOM.....	120

FUNDACIÓN IDONIAL	122
INDRA	124
INGECIBER.....	126
INSYTE ELECTRONICS.....	128
INTARCOM.....	130
INTERGRASYS.....	132
ISDEFE.....	134
JEMA.....	136
LEADING.....	138
LIDAX.....	140
MAMMOET IBÉRICA	142
MECÁNICAS BOLEA.....	144
MECANITZATS PRIVAT.....	146
METROMECAÍNICA.....	148
MONCOBRA.....	150
NADETECH.....	152
NANOKER.....	154
NATEC.....	156
NORTEMECAÍNICA.....	158
OBEKI.....	160
OBUU TECH.....	162
OROLIA.....	164
PROACTIVE.....	166
PROCON SYSTEMS.....	168
QUASAR.....	170
RDT.....	172
ROMPAL.....	174
SCHWARTZ HAUTMONT.....	176
SCIENTIFICA.....	178
SEA.....	180
SENER AEROESPACIAL.....	182
SENER RYMSA.....	184
SGENIA.....	186
SOGECLAIR AEROSPACE.....	188
SUPRASYS.....	190
TECNALIA.....	192
TECNATOM.....	194
TECNOBIT.....	196
TEKNIKER.....	198
TEKNO SERVICE.....	200
THALES ALENIA.....	202
THUNE EUREKA.....	204
TVP.....	206
TSK.....	208
TTI NORTE.....	210
VACTRON.....	212
VALTRIA.....	214
VERSE EUROPA.....	216

SPANISH PUBLIC RESEARCH ENTITIES

ASTRONOMY INSTITUTO DE ASTROFÍSICA DE ANDALUCÍA.....	222
CALAR ALTO.....	224
OBSERVATORIO DE SIERRA NEVADA.....	226
INSTITUTO DE ASTROFÍSICA DE CANARIAS.....	228
GRAN TELESCOPIO DE CANARIAS.....	230
OBSERVATORIOS DE CANARIAS.....	232
OBSERVATORIO DE YEBES.....	234
IRAM.....	236
CEFCA.....	238
OBSERVATORIO ASTROFÍSICO DE JAVALAMBRE.....	240
FUSION CIEMAT. LABORATORIO NACIONAL DE FUSIÓN.....	244
PARTYCLE PHYSICS ALBA.....	248
CIEMAT.....	250
ESS BILBAO.....	252

Foreword

Big Science infrastructures are the backbone of European science. They attract technologists and scientists from various scientific disciplines and act as catalysts for the development of new concepts and theories. But, beyond their contribution to science, Big Science facilities also foster economic development within the countries involved in their design and construction, requiring new technology solutions which improve companies' competitiveness and international projection.

For Spain, involvement in Big Science facilities is a driver to increase our scientific production, to facilitate international collaboration, to test our capacities in very singular projects and to assess our R&D policy. In the last fifteen year span, our industries have developed Big Science projects worth more than 1600 million euros in technologies of the uttermost complexity, such as optomechanics, cryogenics and vacuum, magnets, diagnostics, new materials, instrumentation & control, detectors or ICT.

Recent worldwide events, such as the covid pandemic coupled with its economic aftermath and the current conflict in Ukraine, are undoubtedly posing significant challenges to our economies and innovation ecosystems. Fortunately, the European Union has taken a step forward and, by means of the NextGenerationEU funds, Spain can now handle an iron-strong tool to emerge a stronger country from the current uncertain situation. I firmly believe that the Big Science market is one of the key drivers for success; in fact, numerous NextGenerationEU-funded projects are being launched that will strengthen the collaboration between research infrastructures and industry, increasing the level of European scientific production and the technological readiness of our companies.

As Spain's Home Agency for Innovation, CDTI Innovación plays a key role in supporting our industry to engage in business with Big Science facilities, fostering their technological development by funding cutting edge projects and acting as Industrial Liaison Officer, aimed at achieving an adequate level of industrial re-



turn. This strategy is being pursued both in international science facilities and also domestically with the network of national singular research infrastructures in close cooperation with the Ministry for Science and Innovation.

Our strategy to get involved at the earliest stages of innovation projects is aimed at positioning Spain's industry in future exciting projects, such as the PRISMAC (Programme of High Field

Superconducting Magnets) agreement between CERN, CIEMAT and CDTI Innovación for the design, prototyping, testing and industrial development in magnet engineering, assembly and qualification within the scope of the HL-LHC project and FCC study. In addition, CDTI Innovación offers a wide variety of funding instruments to support science industry innovation projects, such as soft loans for R&D projects, grants for technological startups or grants for collaborative industrial research projects. Other schemes could also be used in the future, such as the Public Procurement of Innovative Solutions (PPI).

An important milestone in 2022 is the Big Science Business Forum in Granada, an event organised by CDTI Innovación along with Spain's Ministry of Science and Innovation and the participation of the most relevant Big Science organisations. This event provides companies and stakeholders with the chance to learn and discuss about business opportunities in the coming years emanating from the Big Science organisations. BSBF2022 is held in Granada in support of the IFMIF-DONES project, the research infrastructure which will enable the testing of materials necessary in a demonstration fusion reactor, the machine that will follow ITER.

This catalogue summarises the capacities of Spanish companies in Big Science facilities and includes a selection of recent success stories and a complete picture of our skills and capabilities. We hope that scientists, companies and research infrastructures, as well as future partners, will find this compendium useful and that many successful partnerships will be encouraged to successfully face the challenges and opportunities ahead of us.

Javier Ponce

Director General CDTI INNOVACIÓN



INSTITUTION
AFFILIATION
ADDRESS
WEB
CONTACT PERSONS

Centre for the Development of Technology and Innovation, E.P.E.
 Ministry of Science and Innovation
 C/ Cid, 4 28001 MADRID (SPAIN)
www.cdti.es

ASTRONOMY Javier Echávarri

E-MAIL javier.echavarri@cdti.es

FUSION Ana Belén del Cerro

E-MAIL anabelen.delcerro@cdti.es

PARTICLE PHYSICS Manuel Moreno

E-MAIL manuel.moreno@cdti.es

PHONE +34 915810491

EMAIL dptoGIPD@cdti.es

CDTI MAIN ACTIVITIES

CDTI Innovación is the national innovation agency belonging to the Spanish Ministry of Science and Innovation, fostering the innovation of Spanish companies including the Big Science market. We run these activities from its headquarters in Madrid as well as its international network.

CDTI AND LARGE RESEARCH INFRASTRUCTURES

CDTI Innovación is the official Industrial Liaison Officer (ILO) for CERN, ITER, ESRF, ILL, ESO, SKAO, European XFEL and ESS, fostering the involvement of Spanish industries in these large scientific facilities and providing support for others is the industrial expert in Horizon Europe RIs and EURATOM-Fusion programme committees. In addition CDTI Innovación promotes the participation of Spanish industries and its technology capabilities in the Spanish national scientific and technical research infrastructures (Infraestructuras Científico Técnicas Singulares, or ICTS) in support of the Ministry of Science and Innovation.

We are involved:

1. With Industry

- Raising awareness and informing potential suppliers about medium and long-term plans of the research infrastructures as well as forthcoming calls for tenders
- Assisting companies in their understanding of the technical, contractual and financial requirements to become a supplier and monitoring of awarded contracts

2. With Research Infrastructures

- Informing research infrastructures on our national industrial capabilities.
- Supporting international and national research organisations to create collaborations and partnerships with industry in the R&D phase and promoting technology transfer activities, often through the participation in European projects.
- Providing advice on the definition and implementation of the organisation purchasing rules
- Organising industrial events such as the Big Science Business Forum 2022, international infodays, Spanish national events at the RIs, national infodays and workshops with the ICTS network.

3. With Delegations / Funding agencies

- Collaborating with the Spanish delegation to the Research Infrastructures as expert for industrial matters, advising national funding agencies in the definition of in-kind contributions and analysing industrial capacities for Spanish Research Infrastructure proposals
- Collaborating with the Spanish Ministry of Science and Innovation as member of the member of the ICTS committee, lending support for industrial and technology matters.

SPANISH COMPANIES IN LARGE SCIENTIFIC FACILITIES

Since 2005, Spanish industry has been awarded over 1600 million euros from large scientific facilities ¹, won in a highly competitive market without rules of guaranteed georeturn. Our national industry has contributed to the main technological areas of these projects in areas as relevant as mechanical engineering, control systems, electro-magnetism and superconductivity, power systems, radiofrequency systems, cryogenic and vacuum systems, etc.

Accumulated industrial Return in Large Scientific Facilities - Astronomy, Particle Physics and Fusion

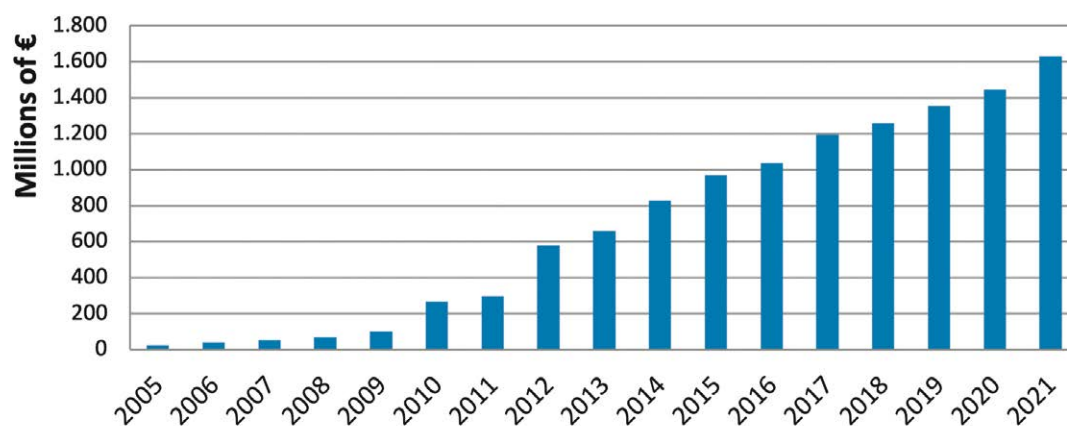

Figure 1. Evolution of industrial return for Spain from Large Scientific Facilities

SPECIFIC FUNDING TOOLS RELATED TO LARGE RESEARCH INFRASTRUCTURES

CDTI Innovación supports industrial research and innovation projects for large scientific facilities with a wide variety of funding instruments which cater for startups, individual projects, industrial consortia and collaboration with research institutions. More details can be found in www.cdti.es.

¹ Large Scientific Facilities taken into account: CERN, ESRF, European XFEL, ESO, ESS, ILL, ITER-F4E and SKAO.

HOSTING ORGANIZATION IFMIF-DONES España
ADDRESS Gran Vía 48, 18006, Granada.
WEB www.ifmif-dones.es
CONTACT PERSON **Jose Aguilar**
POSITION Project Office Coordinator
PHONE +34 655 97 75 11
EMAIL jose.aguilar@ifmif-dones.es

IFMIF-DONES, A KEY INFRASTRUCTURE IN THE ROADMAP TOWARDS FUSION ENERGY

The need of a fusion-like neutron source for the qualification of the materials to be used in a fusion power plant has been widely recognized since the beginning of the Fusion Programme.

This Fusion Programme is based in three main pillars, ITER, DEMO and IFMIF-DONES, being this last one the fusion neutron source facility for materials development and qualification. This fusion relevant neutron source facility (“the Facility”) will provide to DEMO the necessary data for material testing under similar irradiating conditions. Therefore, the Facility should be constructed and operated soon enough to obtain material information to meet DEMO and future power plants planned schedules in compliance with fusion roadmaps.

The Roadmap for the Fusion electricity production is summarized in the figure 1.

WHAT IS IFMIF-DONES?

The International Fusion Materials Irradiation Facility – Demo Oriented NEutron Source (IFMIF-DONES) is a single-sited novel research infrastructure for testing, validation and qualification of the materials to be used in future fusion power plants like DEMO (a demonstration fusion reactor prototype). In relation to this international project, in December 2017, Fusion for Energy (F4E) evaluated positively the joint Spain Croatia proposal to site the IFMIF-DONES in Granada.

The DONES Facility will be a Plant containing all the necessary buildings and systems to house and run an accelerator-based D-Li neutron source to produce high-energy neutrons at sufficient intensity and irradiation volume to simulate as closely as possible the first wall neutron flux and spectrum of future nuclear fusion reactors.

The facility will produce a 125 mA deuteron beam, accelerated up to 40 MeV and shaped to have a nominal cross section in the range from 100 mm x 50 mm to 200 mm x 50 mm, impinging on a liquid lithium target 25 mm thick cross-flowing at about 15 m/s in front of it. The stripping reactions generate a large number of neutrons that interact with the materials samples located immediately behind the Lithium Target, in the Test Modules.

AND IFMIF-DONES IS FINALLY BECOMING A REALITY IN GRANADA...

In 2018, promoted by Spanish and Croatian governments as well as F4E and EUROfusion, the IFMIF-DONES facility has been included in the European Strategy Forum on Research Infrastructures (ESFRI) Roadmap showing up the strategic interest of the facility for the EU scientific community.

Activities focused on the implementation arrangements of IFMIF-DONES has been initiated. In this framework, negotiations are taken place to clarify the organization in charge of the project, the governance of the work to be carried out, financial contributions by all the interested partners, etc. A final international agreement is expected by end of 2022.

The Spanish and Andalusia Governments strongly support the efforts required to develop the Spanish candidature and initial steps in the project preparation are being prepared including the establishment of a Project Office, detailing the technical characteristics of the site and its infrastructures; as well as covering other aspects such as socioeconomics, licensing framework, waste management and decommissioning, as well as the construction of some auxiliary buildings in the proposed site.

As evidence thereof, in June 2021 has born IFMIF-DONES España, which is a public owned Spanish Consortium which goal is to contribute to the European Fusion Program, among others, through its participation in the design, construction, operation and exploitation of the IFMIF-DONES scientific facility.

IFMIF-DONES España will manage and promote scientific, economic, technical and administrative collaboration between the participant entities and will hold the ownership of the scientific-technical infrastructure.

It is no doubt that Spanish industry and its research community is ready to face the challenge to build and operate such prestigious facility. It has the required capabilities and knowhow, and the firm and unanimous support from local, autonomic and central governments.

The construction, operation and scientist exploitation of IFMIF-DONES will have a tremendous positive direct and indirect impact; in Granada, Andalusian, Spain and Europe.

IFMIF-DONES will be a unique facility in the world. Therefore, in addition to its importance for the development of fusion as a source of energy, it will also be important for other research areas and knowledge that may benefit from its technology ... such as medicine, particle physics, basic physics studies, industry, among other. All this in a planet increasingly committed to sustainable development and the use of clean, safe and efficient energy.

The future has begun...and Europe, Spain, Andalusia and Granada are strategically positioned with their contribution to the ITER, DEMO and IFMIF-DONES projects at the forefront of technological development and global innovation.

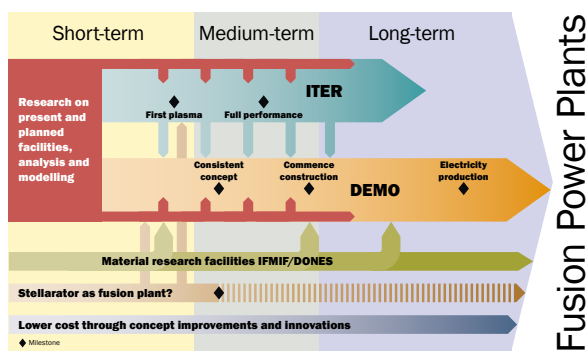

Figure 1 European Fusion Roadmap



Figure 1 European Fusion Roadmap

HOSTING ORGANIZATION INDUCIENCIA, the Spanish Technological Platform of Science Industry
ADDRESS Paseo Ubarburu 39, of. 308. 20014 Donostia (Gipuzkoa)
WEB www.induciencia.es
CONTACT **Leonor Mendoza**
POSITION Head of the Department of Projects
PHONE 943201836
MAIL s.tecnica@induciencia.es

DESCRIPTION

The INDUCIENCIA Technology Platform is a structured forum, with the goal of aligning research and technological priorities around Science Industry. It is led by the industry and managed by INEUSTAR, the Spanish Science Industry Association. INDUCIENCIA gathers the Spanish agents involved in the Science Industry sector: Unique Scientific and Technological Infrastructures (ICTS - Infraestructuras Científicas y Técnicas Singulares), companies of all sizes, universities, scientific facilities, research or technology centres and public bodies (CDTI, AEI, ICEX...).

The works and activities of INDUCIENCIA allow the Platform to orient and focus every effort towards the market, enhancing innovation with the objective of assuring competitiveness, sustainability and growth of the Science Industry sector by promoting public-private collaborations.

MAIN ACTIVITIES

As the reference forum for collaborative activities, in close cooperation with the different stakeholders, INDUCIENCIA organizes different activities aiming at:

- Improving Spanish Science Industry competitiveness by
 - Carrying out networking events
 - Developing specific training programs
 - Acting as consultant for public authorities
- Encouraging R&D activities by
 - Identifying main common industry-academy R&D priorities
 - Coordinating and boost collaborative projects
 - Fostering technology transfer
- Promoting International opportunities by
 - Organizing joint Spanish participation in different international forums (BSBF, IPAC, SPIE, SOFT, LCWS...)
 - Encouraging the analysis of international collaboration and industrial opportunities
 - Setting up direct/reverse missions

MEMBERSHIP INFORMATION

Any Spanish agent involved or interested in Science Industry sector can join INDUCIENCIA.

Membership is free of charge and can be requested by filling in the form found at <https://www.induciencia.es/adherirse?lang=es>



Unique Scientific and Technological Infrastructures workshop opening (April 2022)



SPE booth



ALBA Synchrotron workshop (May 2022)



Unique Scientific and Technological Infrastructures workshop (April 2022)





SPANISH COMPANIES

ABENGOA

COMPANY NAME	ABENGOA
ADDRESS	Energía Solar nº1, Campus Palmas Altas, 41014 Seville (SPAIN)
WEB	www.abengoa.com
TURNOVER	1540 in year 2021
EMPLOYEES	9.450 in year 2021
SME	YES
CONTACT PERSON	Jorge Ceinos Moreno
	POSITION Head of Business Development
	PHONE +34954937111
	EMAIL jorge.ceinos@abengoa.com

COMPANY ACTIVITIES AND SKILLS

Abengoa is an international company that applies innovative technology solutions to sustainable development in the energy, water and industrial sectors.

LARGE SCIENTIFIC FACILITIES AND NATIONAL RESEARCH FACILITIES CONTRACTS

[ITER] Design, Manufacturing and Test of Power Supplies facilities (2020)

[AVIO-ARIANE] Switching Boxes and Automated Test Equipment for VEGA-C Upper Composite EMC Qualification Tests, 2018

[ADS-ESA] Automated Test Equipment for Ariane 6 CMFU and for QUANTUM RX Antenna and GEO-SCAU Unit for Airbus Defence and Space, 2016

[ASIAA] Production and verification of Bias Modules for Band 1 of ALMA (2016)

[ESO] Production and verification of Bias Modules and Cartridge Power Distribution Cards for Band 5 of ALMA (2014)

[ESO] Design, Production and validation of Automated Test Equipment for Bias Modules and Cartridge Power Distribution Cards for Band 5 of ALMA (2014)

[ASD-ESA] Automated Test Bench for Ariane 5 Launcher Electronics Airbus Defence and Space (2014) and Test Bench for Meteosat Third Generation (MTG) Power Distribution Unit for Airbus Defence and Space (2013)

[CERN] Design, Manufacturing and Test of Power Supplies for CERN, DO-(27885 and DO-27770 projects (2013)

R&D PROJECTS

[ESA] TDE for a Battery Management System (2019)

[ESA] TRP for improving the efficiency in energy generation of great installations 'Loop Heat Pipe (LHP) Technology for Solar-Dynamic Energy Conversion (2016)

- [ESA] TRP for Biodegradable Materials for Launchers Systems (2014)
- [ESA] TRP for Environmentally Friendly Hydrogen Production (2013)
- [ESA] GSP for Terrestrial & Space Energy Technology Roadmap (2013)

MARKETS

Nuclear / Defense / Automotive / Naval / Aeronautics / Space / Energy

QUALITY CERTIFICATIONS, NUCLEAR QUALIFICATIONS

ISO 9001 / ISO 14001/ PCAL-AQAP 2120, UNE 166002R&D, OHSAS 18001



ESO and ESA Electronic Testing Equipment, 2019

Facilities for Aerospace department, 2019

COMPANY NAME	AERNNNOVA AEROSPACE, SAU
ADDRESS	c/ Leonardo da Vinci, 13, Parque Tecnológico de Álava, 01510 Miñano, Álava www.aernnova.com
WEB	
TURNOVER	514 million euros in year 2020
EMPLOYEES	4.537 December 2020
SME	NO
CONTACT PERSON	Dr. Miguel Ángel Castillo POSITION VP Technology Development Director PHONE (0034) 91945185600 EMAIL miguelangel.castillo@aernnova.com

COMPANY ACTIVITIES AND SKILLS

Aernnova is a World-Class Supplier of Integrated Aerostructures, Components and Engineering Services. It is 100% Private Company, the 2020 key business figures are: 514 M€ Revenues, 4537 Employees in 6 Countries with 14 Locations and more than 20 different customers.

Aernnova can take full responsibility over the complete life cycle of an Aerospace industrial Program: From Conceptual & Detail Design, Testing, Certification, Prototyping and Manufacturing to Product and In Service Support. Aernnova has an extensive experience and best-in-class composite structures capacities and capabilities and One-Stop-Shop from Raw Metallic Material to Manufacturing and Final Processing.

Aernnova has very strong capacities and capabilities in new complex product development, manufacturing engineering and aftermarket support, especially for complex composite structures. Aernnova holds a wide portfolio of Aerospace Certifications and Approvals from Airworthiness Authorities and Customers including Design (DOA), Production (POA) and Maintenance (MOA) from EASA and AP1020 from Airbus for the Management and Cascade of Design Organization Authority & Signatory.

Aernnova internal know-how and expertise in Developing new Light Weight Structures, Design, Stress, FEM Models, Fatigue and Damage Tolerance analysis, Materials and Processes selection, Quality- Test Management and Configuration Control are applicable to support Large Scientific Facilities technical challenges

LARGE SCIENTIFIC FACILITIES AND NATIONAL RESEARCH FACILITIES CONTRACTS

[ESS-BILBAO] Design and manufacture of the constituent modules of the neutron chopper cascade of the MIRACLES instrument (2021-today)

Scope of work: systems/assemblies of the chopper, operation software for all the axes and parts, wiring to cabinets, auxiliary services and installation at ESS Lund.

[ESS-BILBAO] Supply of a neutron chopper engine (2020)

Scope of work: chopper motor (including spindle, shaft, bearings, and other moving and fastening parts), radial, position and reference thrust sensors, speed sensor and resolver, controller, electronics, and wiring

[ESO]: Testing of VLT/ELT and ALMA Dataflow Software (2020-today)

Scope of work: : Supporting ESO to improve the overall quality of their software products, therefore increasing reliability of their systems and end user satisfaction. To provide quality assurance and testing services that will reduce the time to market and development cost of ESO's software through a combined approach of manual testing and automation. There are some tools involved in the project: Java (main programming language), Jira, Git, Jenkins, Cucumber, Docker, Docker Swarm and Selenium

[CERN] Provision of mechanical design and engineering services (2018)

Scope of work: provision of mechanical design and engineering services at CERN. Including mechanical engineering, design and drawing activities for the accelerator complex, experimental facilities and detectors.

R&D PROJECTS

Aernnova has participated in the R&D phases of big commercial aerospace programs as:

- ESA – SEOSAT INGENIO: Mechanical Ground Support Equipment
- BOEING– 747/8 wing & fuselage sections, 787 wing & tail sections, 747-LCF Swing zone mechanism
- AIRBUS – A380 Fuselage and Tail, A350 Wing and Tail, A220 Center Wing Box.
- EMBRAER – 170/190 Rear Fuselage and Tail, 145 Wing, KC-390
- BOMBARDIER –CRJ700/800/1000 Tail.

Aernnova has been active in R&D projects since 5th FP. In current CS2 Aernnova has a very relevant partnership with Airbus, Onera, DLR, Tekniker, FIDAMC among other key European entities. These CS2 collaborative developments will result on ground and flight demonstrators.

Related to Scientific Installations, Aernnova has participated in the following R&D projects:

- IÑUDE: Chopper design and manufacturing
- DINA: discs for Advanced Neutronic Investigations
- IMPRIME: Strategic advancements on materials through digital printing
- NIZE: Chopper integration within the overall equipment (neutron optics interfaces, mechanical interfaces, interface with general installations...)

MARKETS

Defense / Aeronautics / Space / Railway rolling stock, Naval

QUALITY CERTIFICATIONS, NUCLEAR QUALIFICATIONS

ISO 9001 / ISO 14001

CERN LHC tunnel Pictures during LS2 (credit CERN)



COMPANY NAME	AIMEN TECHNOLOGY CENTRE
ADDRESS	Relva 27 A – Torneiros 36410 O Porriño – Pontevedra - Galicia
WEB	www.aimen.es
TURNOVER	15,6M€ in year 2020
EMPLOYEES	265 in year 2021
SME	NO
CONTACT PERSON	Jorge Menéndez
	POSITION Energy & Large Industry Sales Manager
	PHONE +34 687 448 915
	EMAIL jorge.menendez@aimen.es

COMPANY ACTIVITIES AND SKILLS

AIMEN is an Innovation and Technology Centre founded in 1967 in Vigo. Today, we are a national leader in research and in providing advanced technological services in the fields of joining technologies, materials and laser technologies applied to materials processing and a sought-after partner in international research projects.

Over 50 years in the service of industry, combined with our technical experts' high levels of specialisation and the unique nature and excellence of our facilities, endorse the quality of our multidisciplinary and multi-sectoral technological offer. We carry out our own research, and also partner with companies on R&D projects aimed at developing new technologies and incorporating technological improvements into their products and/or processes, including the development of prototypes and demonstrators. Aligned with a common purpose: to maximise business and industrial performance.

Our specialization areas in R&D are: Advanced Materials, Robotics & Control, Advanced Manufacturing Processes and Environment. Our specialization areas in Industrial Services are: Manufacturing Engineering, Numerical Calculation and Simulation, Mechatronics.

Our laboratories are backed by many official accreditations and recognitions that guarantee our impartiality and technological capabilities.

LARGE SCIENTIFIC FACILITIES AND NATIONAL RESEARCH FACILITIES CONTRACTS

[ESS – EQUIPOS NUCLEARES S.A.] Lasers welding of monolith port blocks for ESS – European Spallation Source (2019-2020)

[F4E - IBERDROLA NUCLEAR] Welding of barrel and connection pipes of the full scale prototype of ITER first wall panels (2017-2019)

[F4E – IDOM] Welding study of different welding technologies applied to the manufacture of diagnostic shield module for ITER ports (2017-2020)

[ITER - EQUIPOS NUCLEARES S.A.] On-site machining technology development implementing of the project OCZ8 - ITER vacuum vessel and port structure welding (2015-2016)

[ITER - EQUIPOS NUCLEARES S.A.] Backing gas system applied in welding process project OCZ8 - ITER vacuum vessel and port structure welding (2014)

[ITER- EQUIPOS NUCLEARES S.A] Design and development of RT inspection procedures and system for its application in joints welded by ENSA in the project OCZ8 - ITER vacuum vessel and port structure welding (2014)

R&D PROJECTS

[H2020 – NMBP] MERGING: Manipulation enhancement through robotic guidance and intelligent novel grippers. H2020-NMBP-FOF-2019, GA 869963

[H2020 – ICT] COLROBOT: Collaborative Robotics for Assembly and Kitting in Smart Manufacturing. H2020-ICT-24-2015-Robotics, GA 688807

[H2020 – NMBP] PENELOPE: Closed-loop digital pipeline for a flexible and modular manufacturing of large components. H2020-NMBP-TR-IND-2020, GA 958303

[SMART EUREKA] REMEDI: REdesign of Large METal Components oriented to Digital Manufacturing.. SMART EUREKA CLUSTER

[H2020 – NMBP] InComEss: Innovative polymer-based composite systems for high-efficient energy scavenging and storage. LC-NMBP-32-2019, GA 862597

[H2020 – NMBP] RETROFEED: Implementation of a smart RETROfitting framework in the process industry towards its operation with variable, biobased and circular FEEDstock. H2020-NMBP-ST-IND-2018-2020, GA 869939

[H2020 – NMBP] DIMOFAC: Digital Intelligent MOdular FACtories. H2020-NMBP-TR-IND-2018-2020, GA 870092

[H2020 – NMBP] LIGHTME: An open innovation ecosystem for upscaling production processes of lightweight metal alloys composites. DT-NMBP-01-2018. GA n°: 814552

[H2020 – NMBP] INTEGRADDE: Intelligent data-driven pipeline for the manufacturing of certified metal parts through Direct Energy Deposition processes. DT-FOF-04-2018, 820776

[H2020 – NMBP] NEWSOL: New StOrage Latent and sensible concept for high efficient CSP Plants. NMBP-17-2016. GA n°: 720985

MARKETS

Nuclear / Defense / Automotive / Naval / Aeronautics / Space / Energy / Oil & gas

QUALITY CERTIFICATIONS, NUCLEAR QUALIFICATIONS

ISO 9001 / ISO 14001

System prototype joints
in situ machining for
Vacuum Vessel

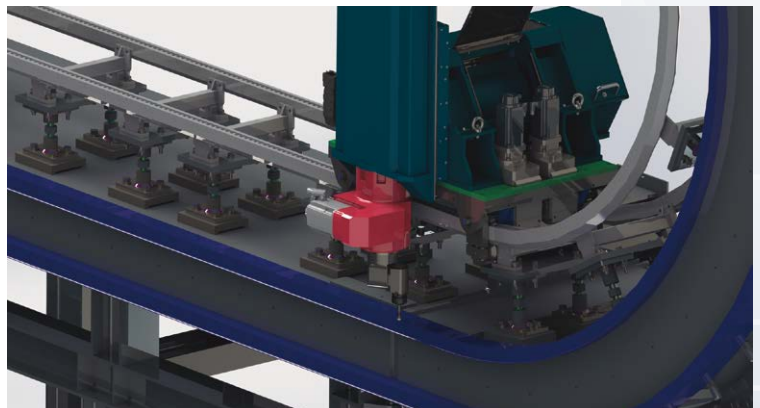



COMPANY NAME	AIRBUS DEFENCE AND SPACE, S.A.U.
ADDRESS	Avenida de Aragón 404, 28022 Madrid, Spain
WEB	www.airbus.com
TURNOVER	159 M€ (Space Systems in Madrid) in year 2021
EMPLOYEES	515 (Space Systems in Madrid) in year 2021
SME	NO
CONTACT PERSON	María del Mar Fernández Lisbona
	POSITION Key Account Manager Space Spain
	PHONE +34915863778
	EMAIL mar.fernandez@airbus.com

COMPANY ACTIVITIES AND SKILLS

State-of-the-art space technologies:

- Prime of complete satellite systems, with fully operational in-orbit delivery.
- Microwave instruments and Active Antenna payloads for satellites
- Thermomechanical subsystems for Satellites and Launchers, including structures for very stringent environments, reflector antennas, launcher payload adapters and multi spacecraft dispensers

LARGE SCIENTIFIC FACILITIES AND NATIONAL RESEARCH FACILITIES CONTRACTS

[ESA] - Land Surface and Temperature Monitoring Copernicus Mission (Kick-off July 2020)

[ARIANESPACE] ARIANE 6 structures (2019 - Onwards)

[ESA] JUICE structure, shielding and thermal subsystems (2018)

[ESA] - CHEOPS satellite (2017). Successfully launched in Dec 2019.

[NASA] – JPL] High Gain Antenna for Curiosity and Perseverance Mars Rovers

[ITER] – Fusion For Energy (F4E) Precompression Rings for ITER Magnet System (2012)

[ESA] GAIA active antenna (2012)

[ESA] GAIA satellite structure (2010)

[CERN] Large Hadron Collider Support Posts (4600 items delivered) (2011)

[CERN] Cylinder for the ATLAS experiment of the LHC (2011) Selected R&D projects of potential interest

[ARIANESPACE] ARIANE 5 structures (1999 - Present)

R&D PROJECTS

FP7 - EUCARBON (2016)

MARKETS

Space

QUALITY CERTIFICATIONS, NUCLEAR QUALIFICATIONS

ISO 9001

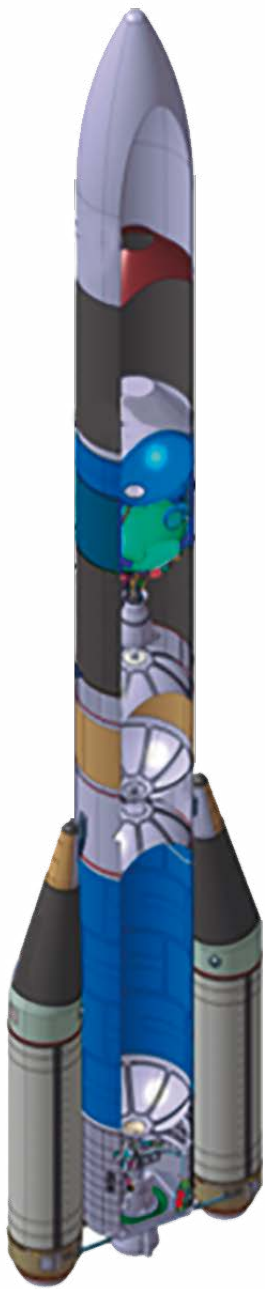

Ariane 6 Structures



CHEOPS Satellite – ESA Mission for the detection of Exoplanets

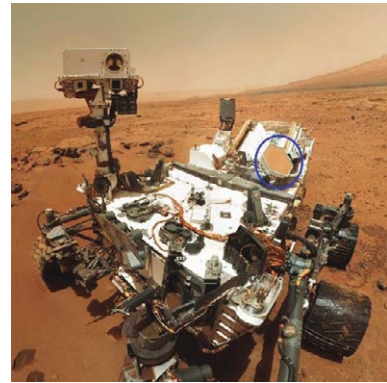

High Gain Antenna of NASA Curiosity and Perseverance Mars Rovers



Cylinder for the ATLAS experiment



JUICE Structure – ESA's mission to Jupiter Icy Moons



GAIA Active Antenna

AIRTFICIAL

COMPANY NAME	AIRTFICIAL AEROSPACE & DEFENSE
ADDRESS	Ctra. Nacional IV km 628, 11407, Jerez de la Frontera, Cádiz, Spain
WEB	airtficial.com
TURNOVER	22.740.000 in year 2021
EMPLOYEES	370 in year 2021
SME	NO
CONTACT PERSON	Agustín Méndez
	POSITION Business Development
	PHONE +34 954 18 90 10
	EMAIL ad.sales@airtficial.com

COMPANY ACTIVITIES AND SKILLS

Airtificial A&D provides complete (design, prototypes, industrialization, mass production), technological (composites, electronics, mechanics, software, electrical) and flexible (wide range of rates and markets) solutions different industries.

Airtificial's capabilities covers a wide range of technologies:

- Design and manufacturing of structures in composites materials guiding the customer through the composites integration process including structural redesign, improvement analysis, production cost optimization and integration with other technologies.
- Development of custom electronic equipment including safety critical devices in a highly regulated and challenging industry such as the aerospace.
- Test means and electrical cabinets including power management and distribution, data acquisition and excitation of a wide variety of signals, buses, communication protocols, etc. Also we develop software solution for test systems (simulation, HMIs, SCADA, etc.)
- Robotics and automated processes. This is not about developing commercial robots, this is about developing comprehensive projects that include analyzing the entire process (procedures, means necessary, time spent, etc.), setting measurable targets hand-in-hand with the customer, and developing the automation solution.
- Mechanical design. Airtificial is an expert in mechanical engineering solutions. Its technical office has over 20 years of experience in conceptual and detailed design, as well as structural analysis, applicable to both onboard parts and jigs & tools.
- Engineering Services. Thanks to its team of over 150 experienced manufacturing engineering professionals, Airtificial A&D stands out as an excellent partner to undertake new industrializations that require implementing new processes, restructuring production factories, and developing full production management systems

LARGE SCIENTIFIC FACILITIES AND NATIONAL RESEARCH FACILITIES CONTRACTS

[F4E] Supply of HEBT Distribution Board (2018-19)

R&D PROJECTS

[CLEAN SKY] Robotic Test Systems for Active Inceptors (ROSSI). This project is focused on the design of a test bench fully automated, able to receive and control a shipset of generic active inceptors (2021-act.)

[CLEAN SKY]. More Automated Factories (MAF). Development of a robotic solution to automate the actuation of the different elements in a cockpit during test execution (2017-20)

[MICT] Industria Conectada 4.0. HEDIFICA. Sensorized composite structures in vacuum environments (2019-21)

[MICT] Industria Conectada 4.0. MODIERCO. With this innovative project we integrate data capture technology for the creation of a digital twin plus the digitization of our product life cycle with the consequent continuous improvement of processes (2019-21)

MARKETS

Defense / Aeronautics / Space

QUALITY CERTIFICATIONS, NUCLEAR QUALIFICATIONS

ISO 9001 / ISO 14001 / NADCAP, EN9100, PECAL/AQAP-2110/2210/2310



HSB01 distribution board



Lower part of the HSB01 distribution board



Upper part of the HSB01 distribution board including high current distribution devices



COMPANY NAME	ALIBAVA SYSTEMS
ADDRESS	Carrer de Ca n'Alzina 118 ^a , 08202 Sabadell, Barcelona, Spain.
WEB	alibavasystems.com
TURNOVER	264.097,97€ in year 2021
EMPLOYEES	5 in year 2021
SME	YES
CONTACT PERSON	Juan Herranz
	POSITION Director
	PHONE +34 935 868 832
	EMAIL juan.herranz@alibavasystems.com

COMPANY ACTIVITIES AND SKILLS

Our mission is to provide technological products and services to the High Energy and Nuclear Physics research community from readout and characterization electronics, to radiation detector development and fabrication, custom engineering services and full mechanical and electronic system integration.

- Educational Alibava System - EASy is a portable, compact and complete system for microstrip sensor characterization for educational purposes. The system introduces high- energy physics and particle detectors to physics students with hands-on experience. It familiarizes the students with concepts such as MIP, charge deposition, full depletion and interstrip pitch among others.
- Alivata System is a portable and compact readout system for silicon sensor characterization. Alivata is based on the GPn and HDRn ASCIC families of IDEAS and enables the user to read out or characterize each individual volume of silicon micro- dosimeters, silicon strip or pad sensors as well as SiPM based detector systems.
- XRay Beam Intensity & Position Systems: single and 4 quadrants systems to perform intensity and position measurements.
- Vacuum (KF 40), Standard (light shielded housing) and Naked (custom integration) configurations.
- Picoammeter especially suited for applications where multi-channel fast acquisition is a concern, i.e. feedback systems.
- Custom Detector and Electronics Development: we can develop detectors and electronics according with the customer needs.

LARGE SCIENTIFIC FACILITIES AND NATIONAL RESEARCH FACILITIES CONTRACTS

[Instituto de Estructura de la Materia] – Supply of a Micro-vertex detector for Wasa@FRS experiment - (2022)

- [Fermilab] – Supply of an up to 20480 chanel custom acquisition system - (2022)
- [CERN] – Supply of several Front End Cards for Strip Detectors development - (2019 - 2022)
- [Centro Nacional de Aceleradores] – Supply of customized Dossimetry System for Protons - (2019)
- [ESRF] – Supply of a 515 nm Laser System for detector development - (2019)

R&D PROJECTS

Development of an automatic control system for radon concentration in buildings (project funded by the Spanish State Research Agency and FEDER funds, Program 2014-2020).

MARKETS

Science



ALIVATA System

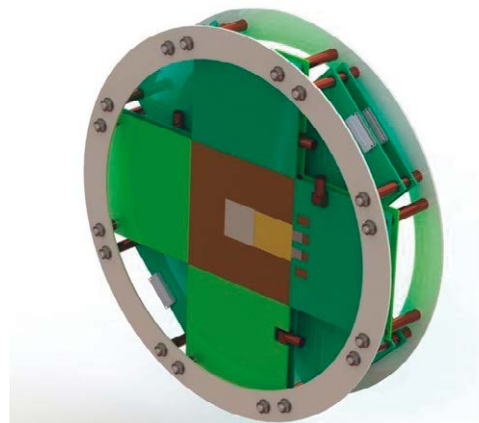

Custom detectors and electronics



Educational Systems for Detector Physics



Xray beam intensity and position systems

ALTER TECHNOLOGY

COMPANY NAME	ALTER TECHNOLOGY TUV NORD
ADDRESS	Calle La Majada 3, 28760, Tres Cantos, Madrid
WEB	www.altertechnology.com
TURNOVER	40 M€ in year 2021
EMPLOYEES	257
SME	NO
CONTACT PERSON	Eladio Montoya Redondo
	POSITION Business Development Big Science – EC Division
	PHONE +34 918 041 893
EMAIL	eladio.montoya@altertechnology.com

COMPANY ACTIVITIES AND SKILLS

ALTER TECHNOLOGY TÜV NORD SAU (hereafter ATN), a member company of TÜV NORD GROUP, is a quality-driven company providing procurement, engineering and test services for electronic systems, equipment and electronics components, within the space and harsh environment markets. ATN works in many markets including, but not limited to, Aerospace, Big Science, Defence & Security, Transport, Energy.

ALTER's activities in Big Science are:

- Project Management as Prime Contractor
- Specialised testing: EMC, magnetic field, nuclear radiation, thermal, mechanical, electrical, optical, chemical...
- Design and automation of ad-hoc test benches
- Electronic design and manufacturing
- Assessment of Compliance with CE marking

LARGE SCIENTIFIC FACILITIES AND NATIONAL RESEARCH FACILITIES CONTRACT

[F4E] F4E-OMF-1106 Support Services in the Fields of CE Marking and Regulatory Compliance (2021-2025)

[F4E] F4E-OFC-Provision of Bespoke Electronic Integration and Manufacturing Services (2021-2026)

[F4E] F4E-OPE-1084-Lot1: Neutron irradiation of ITER bolometer prototypes (2021-2023)

[GTD-F4E] F4E-0811-01-01-14 Qualification tests on 8 I&C equipment within the frame of Front End Cryogenics Distribution System (FECDS)

[IO] IO/21/CT/4300002524 CIS and DLIB Integration Engineering Services (2021-2023)

[CERN] EMC and safety tests on CERN power converters (2019-2022)

[NASA/INTA-CAB] Screening and qualification of the ASIC of MEDA (Mars Environmental Dynamics Analyzer) for Mars 2020 mission (2019)

[F4E/HBM] Gamma radiation tests on vacuum vessel sensors (2019)

[F4E-OMF-0555] Support to develop internal control & compliance procedures for export control and Dual Use components (2015-2018).

[IO] ITER - CFT_11268, Discharge Loop interface box (DLIB) design (2015-2018)

[F4E] F4E-OMF-43 Provision of support to the F4E ITER Department and Project Office Unit in the area of Project Management (F4E-OMF-43), LOT 5, CE marking support. (2014-2018)

R&D PROJECTS

ATN provides engineering services regarding regulatory and product conformity requirements, particularly regulation application and product certification as well as dedicated engineering and testing services for components evaluation for harsh environments, as for the product assurance services: Environmental conditions, reliability/ functional safety analysis, engineering, EMC testing, radiation and magnetics, radio communications and optical testing.

[H2020] HOLDON "HgCdte APD Optimization for Lidar Detection Of greenhouse gases" (2018)

[H2020] HEATPACK "new generation of High thermal efficiency components PACKAGES for space" (2019)

[H2020] VIZTA "Vision, Identification, with Z-sensing Technologies and key Applications" (2019)

H2020. Proyecto SiphodIAS. Optical transceivers para espacio a alta velocidad.

Several R&D ESA Projects: EUCLID, Slogan GaN technology, MTG Meteosat new satellites, MultiPurpose Crew Vehicle (Orion MPCV), etc.. (2014-2018)

ATN as prime contractor for the R&D consortium that develops the Linear Accelerator of Particles which will be built in the Science Park of Aljaraque (Huelva, Spain). These project management and technical capabilities are subject to be transferred to the Fusion for Energy (F4E) scope. (2014)

ATN has performed the Helium vessels inspection for DESY XFEL (X-Ray Free-Electron Laser) for CIEMAT. (2014)

MARKETS

Nuclear / Defense / Automotive / Naval / Aeronautics / Space / Telecommunications

QUALITY CERTIFICATIONS, NUCLEAR QUALIFICATIONS

ISO 9001 / ISO 14001 / ISO 17025: Testing Accredited Laboratory. ISO 17065: Certification Body, Notified Body (NB 2031) RED and EMC European Directives, Regulation (EU) 2019/945 on unmanned aircraft systems and on third-country operators of unmanned aircraft systems

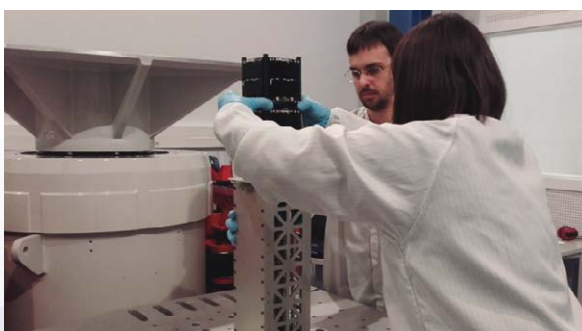

Vibration testing

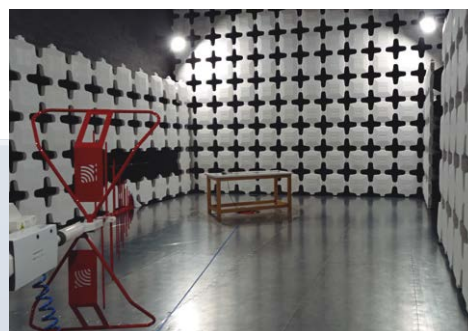

Electromagnetic compatibility

COMPANY NAME	ANTEC MAGNETS, S.L.U.
ADDRESS	Ramón y Cajal, 74 – 48920 Portugalete (Spain)
WEB	www.antec-group.com/magnets/
TURNOVER	222 k€ in year 2021
EMPLOYEES	3 in year 2021
SME	YES
CONTACT PERSON	Rafael Iturbe
	POSITION General Manager (Magnets)
	PHONE +34 94 472 41 64
	EMAIL magnets@antecsa.com

COMPANY ACTIVITIES AND SKILLS

Resistive and permanent magnet design and manufacture, with water or air cooled windings, and high precision laminated or solid magnetic yokes. Main applications so far include particle accelerators, magnetic separation and nanotechnology, among others.

Design and manufacture of superconducting magnets for applications such as particle accelerators, med-tech (protontherapy, MRIs etc.), motors/generators etc.

Cryogenic system design.

All necessary facilities are available at our workshop, including: winding machines, vacuum-pressure impregnating devices, ovens, yoke manufacturing and assembly areas, testing laboratory and a 250 m² clean working area.

LARGE SCIENTIFIC FACILITIES AND NATIONAL RESEARCH FACILITIES CONTRACTS

[CERN] - Design and manufacturing of a Quadrupole magnet for the AD Target Area

[CERN] - Coil supply for the Q74 L quadrupole magnets East Experimental Area

[CERN] - PSB Transfer Line Quadrupole Magnets for the LIU Project

[STFC UK]- Design and manufacture of dipolar magnets for the variable bunch compressor (VBC) in the second phase of the CLARA Project at Daresbury

[CNAO] - Corrector Magnets. 250 Kg. Laminated bonded yokes & water cooled coils.

[CERN] - Combined horizontal/vertical corrector magnets, for the HIE-ISOLDE project. 50Kg. Solid iron yokes and water-cooled coils wound from hollow copper wire. Stringent dimensional tolerances.

[PSI] - Quadrupoles for the Gantry 3 facility at Paul Scherrer Institute (Switzerland). Water-cooled coils wound from hollow copper wire, stacked magnetic yokes, Ø100 mm aperture. 730 kg

[ESRF] - Engineering design, manufacture and testing of the quadrupole magnets for the storage ring

[XFEL] - Combined superconducting magnets (2 dipoles + 1 superferric quadrupole). 103 magnet series.

[CERN] - Manufacturing and testing (magnetic and cold) of 1.600 Corrector Sextupole Magnets for the LHC; rate of 40 units per month.

[CERN] - Manufacturing and testing (magnetic and cold) of 200 Twin Corrector Octupole Magnets for the LHC; rate of 10 units per month.

R&D PROJECTS

Research and development into new High Temperature Superconductors-based aeronautical electric drives in the frame of a UE-funded project, HIVOMOT.

Design and manufacture of an electromagnetic system for magnetic alignment of recycled magnetic powder for rare earth permanent magnets manufacture

Manufacturing design and fabrication of the active part of a Direct Drive Power solution to be used in a wave energy converter

Design and manufacture of a Superconducting compact cyclotron for radioisotope production for PET medical applications. Project funded by CDTI (CENIT)

Design and manufacture of a new concept of a wet basis magnetic separator.

Design of a Superconducting 4m long Quadrupole for Hi-Lumi Project (CERN). Project funded by the UE.

MARKETS

Nuclear / Defense / Naval / Aeronautics / Energy / Medicine, nanotech, mining, magnetic separation

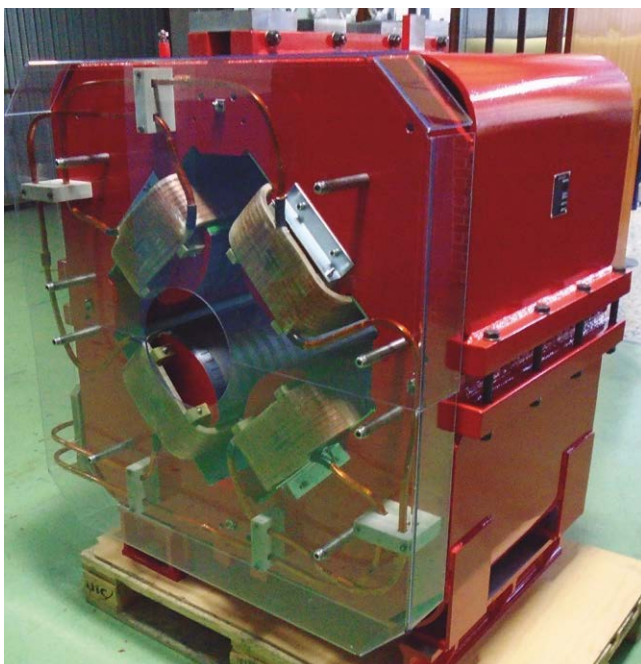

**QUALITY CERTIFICATIONS,
NUCLEAR QUALIFICATIONS**

ISO 9001

Quadrupole Magnet for the Antiproton Decelerator (AD) - CERN

COMPANY NAME	APPLUS+ LABORATORIES (division of APPLUS+ GROUP)
ADDRESS	Campus UAB, Ronda de la Font del Carme, s/n, E-08193 Bellaterra (Barcelona) Spain www.appluslaboratories.com
WEB	
TURNOVER	€1,776.7 € (224 M€ Applus Laboratories) in year 2021
EMPLOYEES	25,000 (1,792 Applus Laboratories) in year 2021
SME	YES
CONTACT PERSON	Alfons Carpio / Elisabet Ribera / James Steel POSITION R&D Program Manager / Corporate Innovation Division PHONE 667 185977 EMAIL Alfons.carpio@applus.com / Elisabet.ribera@applus.com / James.steele@applus.com

COMPANY ACTIVITIES AND SKILLS

Applus Laboratories is a division of the multinational Applus that has presence in more than 70 countries WorldWide.

Since 1907, our testing expertise and our network of renowned laboratories makes us best placed to support innovation through the whole product value chain, offering testing, product-development and certification services.

We offer to our customers and partners:

- a) State of the art and differential multidisciplinary laboratory facilities including Mechanical, Electric & Electronics, Fire and Cybersecurity, among others.
- b) Turnkey Test Bench engineering services supported by our more than 100 years of uninterrupted testing activity.
- c) Quality services and a solid management system backed by a large number of international technical approvals and customer recognitions.
- d) Expertise in participating in challenging project, including European Funded projects and supporting large organizations in Aerospace, Automotive and Energy sectors.

LARGE SCIENTIFIC FACILITIES AND NATIONAL RESEARCH FACILITIES CONTRACTS

[CERN] - HL-LHC Cryomagnets: Assembly Tooling (2019-2020)

[ESA] - Control Command Test Bench for Ariane 6/Vega/Vega-C Thrust Vector Actuator Sub-systems (2018-2020)

[Royal Mint of Spain] - Cybersecurity evaluation through the Common Criteria certification scheme for the third version of the Spanish Digital Identity Card Qualified Signature-creation Device (2017)

[ITER] - Contract for the Execution of Mechanical Tests on Intercoil Structures at cryogenic temperatures (2016)

[ESA – FLPP] - Curved panel structural test for Vega launcher (2016)

[ESA] - Vibration & Shock Test in an Optical System for Euclides project (2015)

[ESA] - Material characterization of on AL structure for Vega launcher (2013-2014)

R&D PROJECTS

Applus+ have more than 200 active research projects and involve more than 800 employees.

Applus Laboratories is active in cooperative research programs leading several ones.

MARKETS

Nuclear / Defense / Automotive / Naval /Aeronautics / Space / Energy / Oil & gas
 Other: Civil Engineering (large building structures)

QUALITY CERTIFICATIONS, NUCLEAR QUALIFICATIONS

RCC-MR / IISO 9001 / ISO/IEC 17025 / EN 9100 / Common Criteria (SOCIS) / NADCAP

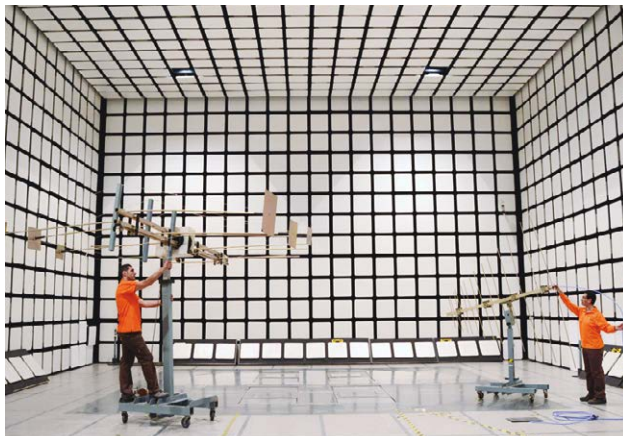

Applus Electromagnetic Compatibility Test Facility

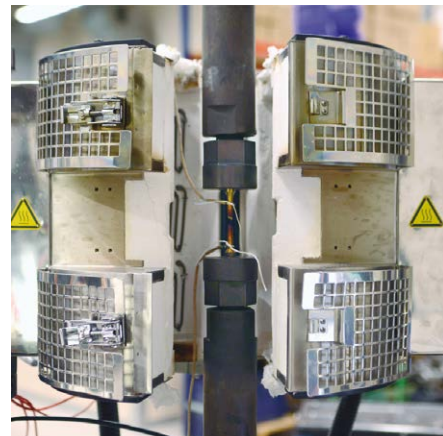

Applus Mechanical Test High Temperature Test Facility



Applus Mechanical Test Laboratory



ITER Project - Mechanical Tests on Intercoil Structures at cryogenic temperatures



COMPANY NAME	ARCECLIMA SISTEMAS Y APLICACIONES, S.L.
ADDRESS	Parque Empresarial Alvedro, I-17, 15180 Culleredo
WEB	www.arceclima.com
TURNOVER	36 M€ in year 2021
EMPLOYEES	167 in year 2021
SME	YES
CONTACT PERSON	Jorge Buceta Freire
	POSITION Head of Special Projects
	PHONE +34 674015362
	EMAIL jorgebuceta@arceclima.com

COMPANY ACTIVITIES AND SKILLS

Established In 1994, Arce Clima started a new project to become a leading provider of design, installation and maintenance solutions in the fields of HVAC and Fire Protection

Proven experience in 18 European countries, including UK, Italy, France, Germany.

Thousands of Projects done, Arce Clima is especially skilled in accomplishing the planning.

Arce Clima has carried out several major projects over 5.000.000 €, some not located in Spain.

About 25 Project Managers, many of them experienced in several different European countries.

Arce Clima has developed its own SCADA systems focused on improving HVAC efficiency.

Experienced in BIM projects.

Diversity of designs and installations: Logistic centers, Data Process Centers, Factories, CERN (Industrial), Commercial Centers, Historical buildings.

LARGE SCIENTIFIC FACILITIES AND NATIONAL RESEARCH FACILITIES CONTRACTS

[CERN] CONTRACT F760/EN/HL-LHC - Primary and Demineralized Water Cooling Systems, Sump Raising Systems, Firefighting Network and Pipework for the High Luminosity Project (2021-2024)

[CERN] CONTRACT F738/EN - Design, supply, installation, testing and commissioning of the new HVAC Systems for the Antiproton Decelerator Target Areas (2020-2021)

[CERN] CD8469841 - Ventilation system and process facilities for the NANOLAB Project (2020-2021)

[CERN] CD7980451 - Design, supply, installation, testing and commissioning of the cooling stations for the third generation neutron spallation target of n_TOF facility (2019-2021)

[CERN] CONTRACT B1523/BE - Design, supply, installation and maintenance of the Super Proton Synchrotron fire sprinkler system (2017-2018)

[CERN] CONTRACT B1494/EN - Design, supply, installation and commissioning of Heating, Ventilation and Air Conditioning Systems on the CERN Site (2016-2022)

[CERN] CONTRACT F701/EN - Design, supply, installation, testing and commissioning of the water cooling, HVAC and superheated water systems for the new Building 311 (2016-2018)

MARKETS

Naval / CERN

QUALITY CERTIFICATIONS, NUCLEAR QUALIFICATIONS

ISO 9001 / ISO 14001



Electric cubicles
- CERN AD
TARGET



Nuclear filters - CERN AD TARGET

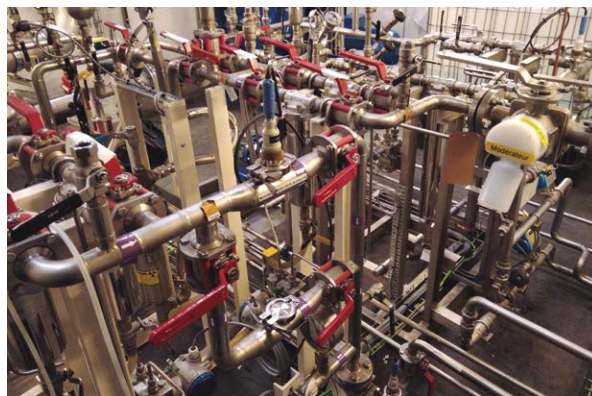

Cooling skid -
CERN n-TOF

ARQUIMEA

COMPANY NAME	ARQUIMEA
ADDRESS	C/ Margarita Salas 10 28919, Leganés (Madrid)
WEB	www.arquimea.com
TURNOVER	23M€ in year 2021
EMPLOYEES	130 in year 2021
SME	NO
CONTACT PERSON	Francisco Gutiérrez
	POSITION Business Development Director (Space)
	PHONE +34 627 49 54 10
	EMAIL fgutierrez@arquimea.com

COMPANY ACTIVITIES AND SKILLS

ARQUIMEA is a Spanish multi-sector technology company that provides solutions in the design, manufacturing and certification of equipment and components for astronomy, fusion and particle physics and also for Space missions and Aeronautic industries.

ARQUIMEA develops mechanical actuators based on Smart materials and deployment mechanisms for space satellites and missions.

ARQUIMEA develops Radiation Hard Analogue, Digital and Mixed Signal ASICs, FPGA based SoCs and processing units.

ARQUIMEA develops and commercialises space subsystems and systems such as cameras, OBCs, sequencers and payload controllers, among others.

In the manufacturing, assembly and Test (MAIT) area, ARQUIMEA is specialized in engineering, in-house manufacturing, assembly and test of short series of prototypes and flight parts and systems with high precision requirements, complex geometries (mechanized and mechano-welding) and electro-mechanical systems.

ARQUIMEA counts with a 90m² ISO-7 clean room that includes a thermal vacuum chamber for testing of space systems, parts and components.

LARGE SCIENTIFIC FACILITIES AND NATIONAL RESEARCH FACILITIES CONTRACTS

[EST – IAC, CITD] European Solar Telescope heat rejecter manufacturing and test (2022)

[CTA – IAC] Production, Integration and Validation of the mechanical and electronic elements for the Cameras of the LST-2, LST-3 and LST-4 Telescopes (2022)

[ESA] Development and Qualification of a Shape Memory Alloy Valve for Propulsion Passivation (2022)

[ESA] - Online detection and diagnosis for radiation-induced errors in COTS microprocessors (2022)

[CIEMAT] – Manufacture and supply of collars for the second MCBXFB HL-LHC magnet prototype, (2021)

[CLIPPER – CIEMAT]– Design, manufacture and supply of a “Vacuum Permeater” for the injection of H gas, deuterium or other mixtures into a liquid PbLi stream (2020).

R&D PROJECTS

ARQUIMEA participates in R&D projects such as (last 3 years):

[Clean Sky] AVIATOR – A proof-of-concept lowcost sensor network for the monitoring of UFP, PM and gaseous species such as NO_x and SO_x, across airport and surrounding communities (2022)

[H2020 – LIFE] NANOEXPLORE - System to characterize exposure levels to Nanoparticles in urban areas (2022)

[Innovation Procurement] - Ayto. Madrid - NANOMAD - System to characterize exposure levels to engineered nanomaterials in indoor workplaces and urban areas (2021)

[H2020] EFESOS - Development of mixed signal high speed IPs on Global Foundries 22nm SOI technology for space applications (2021)

[H2020] LABYRINTH: development of drone swarming 4D path-planning algorithms and new U-space services supporting drone swarms auto-guidance (2021)

[H2020] LEA – Large European Antenna – Large Deployable Reflector (LDRS) (2021)

[H2020] ALTAIR – Cost effective and reliable space launch system for small sats access to LEO (2020)

[ESA] ADEO – Passive Deorbit Subsystem. Deployable Drag Sail (2020)

MARKETS

Defense / Aeronautics / Space / Energy / Science Industry

QUALITY CERTIFICATIONS, NUCLEAR QUALIFICATIONS

ISO 9001 / ISO 14001 / UNE-EN 9100, ISO 3835, ISO 14100



ARQUIMEA facilities - clean room



ARQUIMEA project - cameras for Cherenkov North Observatory



COMPANY NAME	ARRAELA, S.L.
ADDRESS	Pol. Ind.vilar Do Colo, Rua Peteiro Parcela M3, Cabanas, 15621, A Coruña, Spain
WEB	arraela.com
TURNOVER	300.000 € in year 2021
EMPLOYEES	7 in year 2021
SME	YES
CONTACT PERSON	Juan Manuel Caruncho Rodado
	POSITION CEO
	PHONE +34629042662
	EMAIL jmcr@arraela.com

COMPANY ACTIVITIES AND SKILLS

ARRAELA is a technological company located in Galicia, with a great load in the area of investigation of materials and later development of Systems based on the same ones in two main areas, the NUCLEAR one and the one of ENERGY.

In the NUCLEAR area, we have developed highly efficient shielding materials and structural capabilities, as well as highly competitive, which make us leaders in the market for Radioprotection of X-rays, γ and Neutrons. A last development executed, has allowed to put in the market a constructive material of high efficiency as barrier to the RADON similar to the membranes but without the problems of risks of puncture of these, among other advantages. In the area of ENERGY, the developments have been focused on the Productive Circle based on the use of energy.

- energy capture.
- thermal storage.
- transport of stored heat.
- energy extraction and exchange.
- incorporation into the energy process.

In such a way that a good capture of thermal energy can be made with a material of own development of high absorptivity (2%) and high conductivity allowing the delivery of the captured energy.

On the other hand, excellent materials that allow us a good thermal accumulation of up to 1MWh/m³ of material, also of our own development, with excellent thermal conductivity in such a way that it allows the use of air as a heating fluid, and working ranges of up to 700°C, based on Sensitive Heat, competitive and of simple engineering allowing the transport of the captured and accumulated energy.

LARGE SCIENTIFIC FACILITIES AND NATIONAL RESEARCH FACILITIES CONTRACTS

[Projeto Vila Real CHTMAD PORTUGAL] Radiotherapy bunker with concrete bricks (2021-2022)

- [ALBA SYNCHOTRON] Radiological protection. Experimental Line (2022)
- [FUNDACION CHAMPALIMAUD LISBOA] Manufacture and delivery for mobile radiological shielding and concrete bricks (2018-2021)
- [HOSPITAL DE CRUCES] Brachytherapy vault with concrete bricks (2019)
- [HOSPITAL JUAN CARLOS I] Brachytherapy facility room, doors (2019)
- [HOSPITAL VALL D'EBRON] Brachytherapy vault with concrete bricks (2019)
- [LASER PET, UNIVERSIDAD DE SANTIAGO DE COMPOSTELA] Manufacture and delivery for mobile radiological shielding (2016)
- [CENTRO DE LASERES PULSADOS] Concrete walls, doors and beam dumpers for radiological protection (2015-2016)
- [HOSPITAL DE COIMBRA PORTUGAL] Vault with concrete bricks (2015)
- [CIEMAT] Neutron shielding door for "Neutron Pattern Laboratory for CIEMAT" (2012)
- [ALBA] Linacs plug's and hatches guillotines (2011)
- [ALBA] 2 hatches in lead for ALBA storage rings at These two hatches correspond to Optical Station and Experimental Station and a hoist with 1000kg. CELLS. of capacity. Hatches were self-supporting structures (2011)
- [ITN PORTUGAL] Vault and door for neutron radiation (2010)

R&D PROJECTS

- POLYPHEM: Development of materials and systems for thermal storage with oil (2018-2022)
- TANKSUN: Development of materials and systems for thermal storage with salts (2019-2022)
- TEKRA : Development of construction material as a radon barrier (2018)

MARKETS

Nuclear / Energy

Oncological
bunker door.
Cuenca



Multipurpose
concrete rays
gamma and
neutrons. Density
4Kg per m³



Bunker CLPU Salamanca



COMPANY NAME	ASE OPTICS EUROPE (Twoptics Systems Design SL)
ADDRESS	Carrer Cerdanya 44, 08820 El Prat de Llobregat
WEB	www.aseoptics.com
TURNOVER	1.200.000 in year 2022
EMPLOYEES	15 in year 2022
SME	YES
CONTACT PERSON	Lidia Briquets
	POSITION Sales & marketing manager
	PHONE 937379863
	EMAIL info@aseoptics.com

COMPANY ACTIVITIES AND SKILLS

Twoptics Systems Design SL was created in 2011 and develops its activity using the commercial name ASE Optics Europe (ASE). The company is founded on the desire to have freedom to innovate. The main specialty is optical systems design and integration, with founders being experienced professionals in optomechanical engineering and optics business, accumulating over 30 years of technical and business experience. The firm has developed complex optics and photonics enabled systems, integrating physics, photonics, optics, and mechanics, electronics, scientific imaging, and systems design. ASE has provided solutions for its customers in various industries, principally in: Optical Metrology and Industrial inspection, Defence, Astrophysics, Biotechnology, and Large Scientific installations in applications in both imaging and non-imaging.

ASE has provided R&D services to programs or installations such as: ESRF, CIEMAT, ITER and IAC-IACTEC.

Additionally, ASE serves the private market as well, pulling innovation from one area to the other, allowing ASE to go beyond the state of the art.

LARGE SCIENTIFIC FACILITIES AND NATIONAL RESEARCH FACILITIES CONTRACTS

[IAC-IACTEC – DRAGO] Design and development of custom SWIR Objectives for DRAGO 2 (2021)

[BROOKHAVEN NATIONAL LAB – COLIAT] Design and fabrication of an optical attachment to an autocollimator to increase divergence for measuring large radii at short distances (2020)

[ITER - Bertin Technologies], Transfer of MS prototype, Measurements of in-vessel components tiles with the TARMS and TARMS measurement deployment. (2020)

[ESRF] 0.8X projection objective design, manufacturing and test (2020)

[ITER - Veolia Nuclear Solutions Ltd], F4E-OMF-0633-01-08, T08, Preliminary Design of the IVVS - Phase 1 (2018)

[ITER –Oxford Technologies Ltd], F4E-OMF-0633, 1550 nm, Engineering support in the

area of Remote Handling with F4E (2016)

[ESRF], Objective Lens 150 mm objective to image at infinity a fluorescent screen. Design, manufacturing, assembly and test (2015)

[ITER – Oxford Technologies Ltd]. F4E-574-CON-03-B. 800 nm, Re-design, prototype and test the IVVS probe optical system (2014)

[ESRF] Objective Lens, 400mm collimation objective lens. Design, manufacturing, assembly and test (2014)

[ESRF] Objective Lens 0.5X - Design, manufacturing, assembly and test (2013)

R&D PROJECTS

MISIONES – CDTI. 2021, MORERA, System for Efficient Irrigation Monitoring and Agricultural Performance

EUROSTARS – Eureka. Interempresas 2. 2017, MINALEM, Micro and Nano optical structures for high efficient technical emergency and general lighting.

H2020-NMBP-2016-2017, 2016, OPTOGENERAPY, Optogenetic Protein Therapy for Multiple Sclerosis, new interferon-β (IFN-β) drug delivery system to revolutionize Multiple Sclerosis treatment.

FP7-2013-NMP-ICT-FOF(RTD), 2013, FABIMED, Fabrication and functionalization of BioMedical Microdevices. WP10: optical inspection

MARKETS

Nuclear / Defense / Aeronautics / Space / High precision non destructive inspection



ESRF 3 Objectives and Relay

Optical assembly area

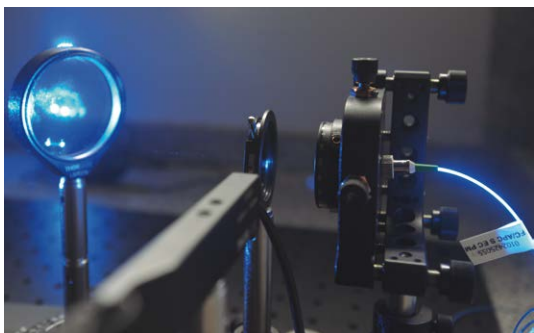

Laser systems integration - NDT

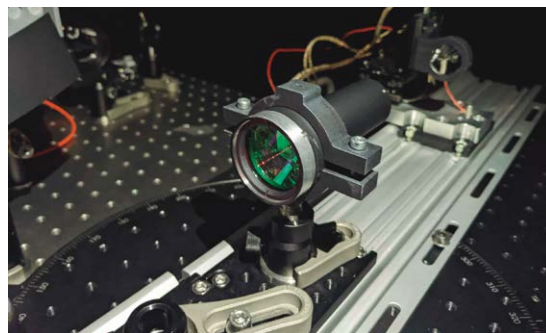

Custom SWIR objective for Space application

COMPANY NAME	ASTURFEITO
ADDRESS	Avenida Metalúrgicos 14B, 33417 Avilés (Asturias), Spain
WEB	www.asturfeito.com
TURNOVER	50 M€ in year 2021
EMPLOYEES	240 in year 2021
SME	YES
CONTACT PERSON	Álvaro Zarza
	POSITION Business Development Manager
	PHONE +34-985514024 / +34-650656625
	EMAIL azarza@asturfeito.com

COMPANY ACTIVITIES AND SKILLS

Asturfeito is specialized in supply of precision assemblies and turn-key systems for energy, marine, defense, aerospace, nuclear and Big Science markets. With more than 25 years of experience Asturfeito covers the full value chain including engineering, manufacturing, mechanical / hydraulic / electrical assembly, systems integration, FAT testing and site assembly/commissioning. From our HQ office, using the latest design and simulation software, we provide engineering and design-to-cost support to our clients while our project management and quality teams assure the projects are delivered on-time according to the highest quality requirements.

Our 4 manufacturing workshops, with a total covered surface of 35.000 m², boost a wide range of state-of-the art equipment including:

- Robotic welding up to 15 tn and 8 x 5 mts. envelope
- Wide range of CNC machining centers – above 30 off - including 10 mts. diameter lathe or 150 tn. boring machine.
- 30x10x10 mts. blasting & painting cabins.
- Segregated area for stainless steel processing including pickling & passivating and fiberglass blasting cabins.
- Large mechanical assembly area with 25 mts under hook and 2 clean areas for assembly, integration and testing.

Asturfeito location by Aviles Port allows the trouble-free delivery of large assemblies in one single piece with no limitation of weight or dimensions.

LARGE SCIENTIFIC FACILITIES AND NATIONAL RESEARCH FACILITIES CONTRACTS

[ESS] Design, manufacturing, testing and site installation of Bifrost Cave Roof Hatch (2022)

[ITER] Manufacturing and site assembly of Port Cell Mock-Up (2021)

[ESS – ANSALDO] Manufacturing, assembly and testing of ESS Active Cell Floor Valves and Intrabay Doors (2020)

[ESO – CIMOLAI] Design, manufacturing, testing and site installation of M1 Segment Crane for ELT telescope (2019)

[ESS] Manufacturing, assembly and testing of Monolith Vessel Inner Shielding (2019)

[ILL] Manufacturing, assembly and testing of Monochromator Shielding (2017)

[ITER – REEL] Manufacturing of main girders for 750 tn ITER main assembly hall cranes (2015)

[LSST – AURA] Telescope Mount Assembly. Including manufacturing engineering, fabrication, mechanical / electrical / hydraulic assembly, testing and site assembly in Chile (2014)

[JT-60 – CIEMAT] Manufacturing, Assembly and Testing of Cryostat Body for JT-60SA Tokamak (2014)

[JT-60 – IDESA] Manufacturing, assembly and testing of Cryostat Base for JT-60SA Tokamak (2012)

[ESO] Supply of 25 radiotelescopes for ALMA project including manufacturing, mechanical assembly, electrical/hydraulic integration, verification & functional tests (2012)

MARKETS

Nuclear / Defense / Naval / Aeronautics / Space / Energy / Oil & gas

QUALITY CERTIFICATIONS, NUCLEAR QUALIFICATIONS

ASME / RCC-MR / IISO 9001 / ISO 14001 / ISO 45001 / ISO 3834-2 / EN 1090 (EXC 4)



Cryostat Body JT-60SA



LSST Mount Assembly



TIG-PLASMA welding robot



COMPANY NAME
ADDRESS

ATS GLOBAL
C/ Leonardo da Vinci, 14, edif PIE
Parque Tecnológico de Álava 01510 Miñano (Álava), SPAIN
www.grupoays.es

WEB
TURNOVER
EMPLOYEES
SME

10 M € (ATS Spain) in year 2021
150 (ATS Spain) in year 2021
YES

CONTACT PERSON

Iker Gutiérrez Llona
POSITION Country Manager
PHONE +34 945 29 69 81
EMAIL iker.gutierrez@ats-global.com

COMPANY ACTIVITIES AND SKILLS

ANÁLISIS Y SIMULACIÓN S.L. was founded in 1997. In 2019 we merged with the innovative ATS Applied Tech. Systems B.V. (ATS Global), ‘The Independent Solution Provider for Smart Digital Transformation’. This merger consolidates our leadership in the Spanish market and provides us with complementary tools to lead the Intelligent Digital Transformation market. The union of strengths of both organizations will cover the broad spectrum of Digitalization Technologies for the Manufacturing Companies and offer solutions for the integration of processes for product design and the manufacturing process. This extension of our knowledge positions AyS Group as a center of excellence and world reference of PLM and Manufacturing knowledge.

We are working in the business of software implementation and in the business of mechanical engineering services.

In software implementation we are the leading company in Spain to supply and implement cutting edge engineering solutions: Product development and innovation (CAD-structural CAE and CFD) / Manufacturing processes optimization (CAM-manufacturing CAE) / Product Data Management (PDM) – Product Lifecycle Management (PLM) / IT hardware / MES/MOM.

In mechanical engineering we offer services in the fields of numerical simulation (structural, fluid dynamics and manufacturing processes); instrumentation & data acquisition & data analysis; and computer aided manufacturing (CAM) for subtractive manufacturing.

Our solutions and services applied to the industrial sector enables us to deliver great value to our customers, in their products and / or processes, reducing costs and improving productivity and competitiveness. We also offer a yearly schedule of “open/standard training courses” and “Ad Hoc training courses” designed to provide exclusive knowledge to companies. Our staff of engineers and technicians has many years of experience and knowledge in the main industries: space, aeronautic, automotive, wind energy, railway, machinery, medical devices, etc.

LARGE SCIENTIFIC FACILITIES AND NATIONAL RESEARCH FACILITIES CONTRACTS

[ESA – SENER] onesat mission (2020): mechanical and thermal analysis of telecommunications units

[ITER – UTE FERROVIAL-VINCI] Big doors 51 & 52 (2018): mechanical analysis

[ESA – TRYO AEROSPACE] metop-sg series mission (2016): mechanical and thermal analysis of telecommunications units

[ESA - IFAE] euclid mission (2016): mechanical analysis of scientific instrument

[ESA – MIER COMUNICACIONES] mtg series mission (2014), smallgeo mission (2011), galileo mission (2006), smos mission (2002). Mechanical and thermal analysis of telecommunications units

R&D PROJECTS

[HAZITEK] ALUJOINT project (2020-2022). New light chassis.

[HAZITEK] FINT project (2020-2021) Intelligent manufacturing unit for hybrid polymers moulding

[HAZITEK] DIGISTIR project (2020-2021) DIGITAL TWIN development of a “Friction STIR Welding” manufacturing unit

[MINECOR] TOUCHSENSOR 4.0 project (2020-2021) Injection moulded products with touch functionality on a certain area of its surface

[MINECOR] POLYSENSOR 4.0 project (2019-2020) Thermoplastic Matrix Piezoresistive Materials for Greater Integration of Sensors in Injection and Additive Manufacturing Products

[HAZITEK] NEWCAUTO project (2019) Product and process development of automotive components

[HAZITEK] COSMOHS project (2019) NEW TURBO SUPERCHARGER DRIVE SYSTEM FOR SUPER INTELLIGENT HYBRID ENGINES

MARKETS

Automotive / Naval / Aeronautics / Space / Energy / Railway & Machinery & Medical devices

QUALITY CERTIFICATIONS, NUCLEAR QUALIFICATIONS

ISO 9001 / ISO 14001



ESA Liftoff of Ariane flight VA233, carrying four Galileo satellites, from Europe Spaceport in Kourou



ESAAOES Medialab The SMOS mission makes global observations of soil moisture over Earth landmasses

COMPANY NAME	AVANCEM
ADDRESS	Pol. Ind. La Cerrada II, 25. 39600 Maliaño, Cantabria
WEB	www.avancem.es
TURNOVER	365432.86 in year 2021
EMPLOYEES	6 in year 2021
SME	NO
CONTACT PERSON	Fernando Mirapeix
	POSITION Director of Engineering
	PHONE +34 666554133
	EMAIL fmirapeix@avancem.es

COMPANY ACTIVITIES AND SKILLS

Advance Engineering Mademan, S.L. (Avancem) is a technological based engineering company where innovation and R&D is in our DNA. Our know how is applied in Radiofrequency, Ultra High Vacuum, Cryogenics and precise Mechanics. We count with own manufacturing capabilities specialised in machining and welding. Our bridge cranes are 10Tm. Almost all activities are concentrated in our headquarters (10000 m²). In this sense we can provide a complete expertise cycle:

- Design Engineering
- Manufacturing engineering
- Manufacturing
- Integration (even in clean room)
- Verification & Test

Avancem provides our customers all the way up from the conceptual design to turnkey solutions.

Our main customers are either private firms as public research centres in fields as particle accelerators, astrophysics, space, defence and industry.

LARGE SCIENTIFIC FACILITIES AND NATIONAL RESEARCH FACILITIES CONTRACTS

[IFCA] Design, manufacturing and commissioning of a cryostat to measure CCDs; Ironman (2021)

[ALBA-CELLS] Precise motorised platforms for Lorea (Ultra High Vacuum) (2021)

[INTA] Design, installation and commissioning of a double ISO 5 removable clean room to characterize PLATO (2021-2022)

[INTA] Cynematic mounts for PLATO (2021-2022)

[Universidad Politécnica de Valencia] Manufacturing of PMTs for NEXT (2022)

[LSC] Machining of the radiopure copper shielding for NEXT (2021-2022)

[DIPC] Chemical cleaning and etching of copper elements for NEXT (2021-2022)

[INTA] Redesign, manufacturing and test of cryosections for the thermal characterisation of PLATO (2022)

[CIEMAT] Design, manufacturing, supply, transport, installation and commissioning of a experimental setup to characterize burning in lithium (2022)

[IAC] Supply of a cryogenic cryocooler for the new detection subsystem Osiris (2021-2022)

[Empresarios Agrupados] Design, development and delivery of a complete system to test Lithium events (LiFire) (2022)

R&D PROJECTS

ECOGEN. Diseño y desarrollo de un sistema de guiado de muy alta potencia y eficiencia microondas para instalaciones científicas y de telecomunicaciones (2021-2023)

MARKETS

Nuclear / Defense / Space / Energy / Science

QUALITY CERTIFICATIONS, NUCLEAR QUALIFICATIONS

ISO 9001 / ISO 14001

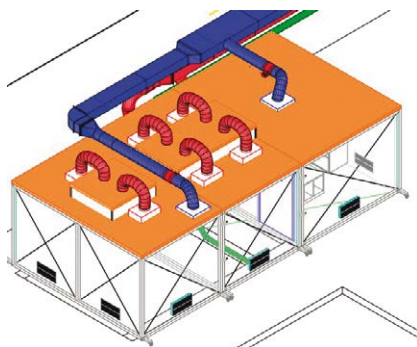

Clean Room



IronMan



Shielding Next

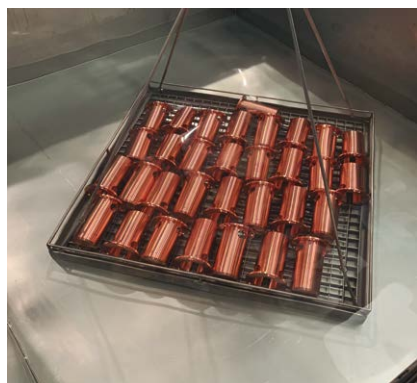

Chemical Cleaning2



LiFire

COMPANY NAME	AVS Added Value Industrial Engineering Solutions S.L.U.
ADDRESS	Polígono Industrial Sigma, Xixilion kalea 2 bajo, Pab. 10; 20870 Elgoibar
WEB	www.a-v-s.es
TURNOVER	22 M€ in year 2021
EMPLOYEES	110 in year 2021
SME	YES
CONTACT PERSON	Mr. Miguel Ángel Carrera
	POSITION CEO
	PHONE +34 943 821 841
	EMAIL macarrera@a-v-s.e

COMPANY ACTIVITIES AND SKILLS

AVS is proud to be one of the world's leading companies in the design and development of complex and critical equipment for Large Scientific Facilities and Research Infrastructure across the world. With offices in Spain and France and subsidiaries in the UK and USA, we are strongly focused on the development of outstanding mechanisms and instruments, and we aim to provide technology-based services to innovative and challenging projects in the fields of Particle Physics, Fusion, Astrophysics and Space.

Our expertise covers design, manufacturing, assembly, tests and supply, providing our customers all the way up from the conceptual design to the turnkey. Among our capabilities are engineering design, mechatronics, diagnostics and instrumentation, high-precision positioning systems in UHV, high magnetic fields, cryogenics and radiation, micro-mechanisms, opto-mechanical systems, deployment mechanisms and thermal control systems for Space.

LARGE SCIENTIFIC FACILITIES AND NATIONAL RESEARCH FACILITIES CONTRACTS

[ITER – F4E] CXRS Charge-Exchange Recombination Spectrometer (2022-ongoing), Procurement of the Beam Line Components for the MITICA Experiment Stage 2 (2019-ongoing), Manufacturing engineering support for the Diagnostic Systems (2019-ongoing)

[ESS]: [JÜLICH] T-REX Production and delivery of a vacuum chamber, [UKRI] FREIA collimation Vacuum vessel (2022-ongoing), Loki Collimator Vessel: Design, manufacturing and assembly (2019-2021), Loki Detector Vacuum Vessel: Design, manufacturing and assembly (2019-2020), [CNRS] SKADI Study, manufacturing and supply of the collimator and the detector enclosure for the diffractometer (2022-ongoing), [ESS Bilbao] Design, manufacturing and test for the mechanical systems of the secondary spectrometer of MIRACLES instrument (2021-ongoing), Head of the Vessel (2020-ongoing), Connection Ring manufacturing (2019-ongoing), Lower and Medium Monolith Vessel (2018-2021), Design and manufacturing of the Target Drive Unit for ESS (2017-2021), [DTU] BIFROST Spectrometer Vessel and Motion System (2021-ongoing), [PSI] Carriers for ESTIA Selene guide (2019-2021)

[ESA]: [THALES ALENIA-ESA] ISRU Demonstration Mission, CAT, S2P S1-SC-12 Capture bay design and end to end verification of the sign for removal; In orbit servicing (2022-ongoing), [NASA JPL – GMV] STA EE, End Effector for Mars Sample Return (2021-ongoing),

[OHB] CHIME FADU, Full Aperture Disffuser Equipment; Calibration mechanism for CHIME (2021-ongoing), [Leonardo] SFR Gripper of the AGS Subsystem for Sample Fetch Rover Mission (2020-ongoing), PDPUMP for mechanically pumped loop (2018-ongoing), [INTA/CAB] M2020 MEDA Instrument Wind Sensor 2 Structure and Mechanisms PRODEX (2017-2019)

[IAC – Dynamic Intelligent Structures] MiniELF, Detailed Design (2021), Detailed design and manufacture of the two cryostats for the QUIJOTE project (2018-2020)

[CERN – CSIC-IFIC] Assembly of Carbon Fiber Petals for ATLAS upgrade (2021 – ongoing)

[CNPEM-SIRIUS] SAPUACAIA Vacuum Vessel (2020-2022)

[ALBA CELLS] Multiple Wiggler for BL31-Factor (2019-ongoing)

[Horia Holubei] LVVE, Extreme Light Infrastructure, Laser Instrument (2018-2020)

R&D PROJECTS

[CDTI] MISIONES, Industrial Research in technologies and processes applied to IFMIF-DONES in order to evolve in the fusion program (2021 – ongoing)

[CDTI] MISIONES, New Materials, Technologies and Advanced Processes to contribute to the new energy era of Nuclear Fusion (2020 – ongoing)

[CDTI] CIEN, Accelerators and related technologies for large scale scientific facilities (2017-2021)

[SPRI] HAZITEK, LUR-1 satellite -AVS leader- (2020 – ongoing)

[SPRI] HAZITEK, Linear Compact Accelerator for Protontherapy -AVS leader- (2018-ongoing)

[H2020] SME Instrument phase 2, HEART: High Heat Rejection Thermal Control System (2017-2021)

[H2020] RIA, IMPACTA: Innovative mechanically pumped loop for active antennae -AVS leader- (2019 - ongoing)

MARKETS

Nuclear / Space / Energy / Science

QUALITY CERTIFICATIONS, NUCLEAR QUALIFICATIONS

ISO 9001 / EN 9100:2016

BIFROST instrument for ESS



COMPANY NAME	AWGE TECHNOLOGIES, S.L.
ADDRESS	Avda. De los Castros s/n. CDTUC Fase A, P-209 Santander
WEB	www.awge.es
TURNOVER	655.038,29 € in year 2021
EMPLOYEES	8 in year 2021
SME	Yes
CONTACT PERSON	Constantino Ruiz Matanzas
	POSITION Business Development Manager
	PHONE +34 659 927 888
	EMAIL cruiz@awge.es

COMPANY ACTIVITIES AND SKILLS

AWGE Technologies is a technological engineering company that concentrates its activities and skills in two main areas. On one hand Ultra high Vacuum and Cryogenics mixed with mechanics for Large Research Infrastructures and Organisms and private corporations and on the other hand Radiofrequency and Microwaves for Large Research Infrastructures and Organisms as well as for private corporations. In both areas AWGE Technologies do carry out projects involving design, manufacturing, production and verification.

Our skills includes provision of innovative solutions on engineering design, manufacture, verification and test in the fields of particle accelerators, astrophysics, space, defence, industry and health sectors.

LARGE SCIENTIFIC FACILITIES AND NATIONAL RESEARCH FACILITIES CONTRACTS

[YEBES OBSERVATORY]. Supply of a laboratory cryostat for Yebes observatory (2021).

[ALBA]. Supply of one (1) sample cryogenic system for BL06-XAIRA Beamline at the Alba Synchrotron (2021).

[INTA]. Positioning System for Vacuum (2021). Detailed Design, manufacture and Supply of the Shaft Rotatory Feedthrough for the ESS Target Station at ESS-ERIC Accelerator (Lund, Sweden) (2020).

[ESS]. Detailed Design, manufacture and Supply of the Shaft Rotatory Feedthrough for the ESS Target Station at ESS-ERIC Accelerator (Lund, Sweden) (2020).

[IAC]. Design, manufacture and supply of a test cryostat for HARMONI preoptics (2020).

[F4E]. Supply of Vacuum Flanges for the BPM Feedthroughs on the IFMIF/EVEDA Cryomodule (2019).

[ESS]. Detailed Design and Supply of the Waveguide Components for the RF Distribution Chains for the RFQ and DTL of the ESS-ERIC Accelerator (Lund, Sweden). Lot 2. Flexible waveguide sections (frequency 352.21 MHz) (2019)

[ESS]. Detailed Design and Supply of the Waveguide Components for the RF Distribution Chains for the RFQ and DTL of the ESS-ERIC Accelerator (Lund, Sweden). Lot 3. "Special" waveguide sections (2018).

[ILL]. Study, Fabrication and Assembly of a Radial Oscillating Collimator (ROC) for the Instrument XTREMED (2018).

[ALBA]. Machining and verification of different vacuum mechanical pieces (2018-2020).

[CERN]. Isolated Enamelled Vacuum Flanges (2017).

[ESS]. Detailed design, Technical Support and Manufacture of Proton Beam Window Seal Mock-Up (2017)

PROJECTS FOR PRIVATE CORPORATIONS

INDRA. RF-ALQ500 modules upgrade. Re-design, manufacture and qualification of different filter banks range 2-18 Ghz (2019).

INDRA. Design, manufacture, assembly and qualification of a High Power Calibrator Module System (0,5-18 Ghz) (2019).

INDRA. Design, manufacture, assembly and qualification of intermediate frequency signal conditioner and RF signal conditioners (2018).

CAF. RF Design and test for signalling and security balises as part of an automatic train protection (ATP) system (2018).

MARKETS

Nuclear / Defense / Space / Aeronautics / Health / Other Science

QUALITY CERTIFICATIONS, NUCLEAR QUALIFICATIONS

ISO 9001

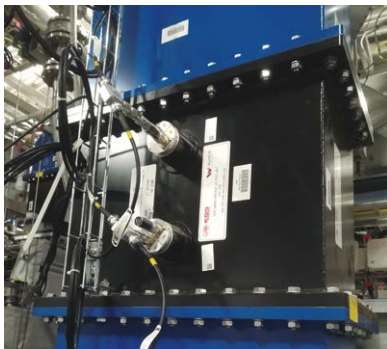

Dual Directional Coupler



ESS Shaft rotatory unit



Test cryostat HARMONI



Phase shifter

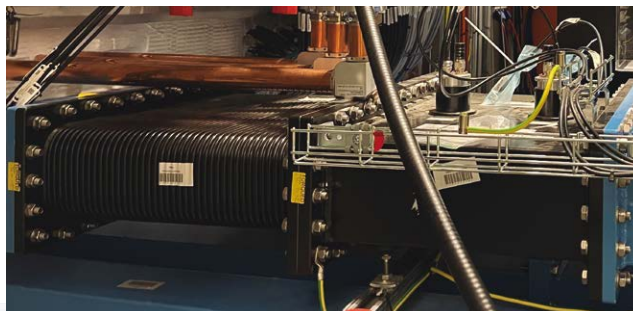

Flexible waveguide

COMPANY NAME	BEN TRADE CABLES IBÉRICA S.A. (BTC Ibérica)
ADDRESS	Polígono Industrial Centrovía, C/ San Francisco Nº 9, 50198 La Muela, Zaragoza
WEB	btciberica.com
TURNOVER	11.837.762 € in year 2021
EMPLOYEES	38 in year 2021
SME	YES
CONTACT PERSON	José A. Herrero
	POSITION SALES MANAGER
	PHONE +34 976 149 149
	EMAIL sales@btciberica.com

COMPANY ACTIVITIES AND SKILLS

BTC Ibérica is a low voltage instrumentation, control, power and special cables factory for petrochemical, offshore, marine industry, refining, steel works, nuclear power plants, general industrial operations and special applications.

Factory located in Zaragoza (Spain), established in 2003. We export worldwide more than 95% of our production through the Sales Departments in Aberdeen (Scotland, UK) and Zaragoza (Aragón, Spain).

In BTC Ibérica, we are cable instrumentation leaders in the UK and Europe and we distribute worldwide through the major suppliers of electrical equipment.

We are suppliers of the largest oil & gas and engineering companies in the petrochemical industry, installing our cables in several projects around the world.

LARGE SCIENTIFIC FACILITIES AND NATIONAL RESEARCH FACILITIES CONTRACTS

[ITER] – Supply contract for cabling supply on demand (2018 – 2021)

[ITER] – Supply of Cables for the Plant Systems in the Tokamak Complex of the ITER Facility (2021 – ongoing)

R&D PROJECTS

[ITER] – Design and production of radiation resistance cable according to ITER requirements.

Instrumentation, control and low voltage power cables. Individual and overall screens with tinned copper wire braid. Halogen free, flame retardant as per IEC 60332-3-23 and radiation resistance as per IEC 60544-2

MARKETS

Nuclear / Naval / Energy / Oil & gas

QUALITY CERTIFICATIONS, NUCLEAR QUALIFICATIONS

ISO 9001 / ISO 14001



BTC Ibérica cable



COMPANY NAME	Broad Telecom, S.A. (BTESA)
ADDRESS	Margarita Salas, 22. Parque Leganes Tecnologico. 28918 - Leganes (Madrid). SPAIN
WEB	www.btesa.com
TURNOVER	11 M€ in year 2021
EMPLOYEES	79 in year 2021
SME	YES
CONTACT PERSON	Carlos Rosa
	POSITION Sales Manager
	PHONE +34 913274363. Ext.411
	EMAIL c.rosa@btesa.com

COMPANY ACTIVITIES AND SKILLS

BTESA is a leading technological group with long experience in the design, manufacturing and installation of radiofrequency equipment

BTESA is the Spanish leading provider of high power SSPA amplifier systems. Founded in 1995 and headquartered in Madrid, it holds a long experience in the design and manufacturing of radiofrequency equipment since its beginnings in the broadcast business.

The key of our successful record of RF equipment delivered all over the world is our powerful R&D department: 30% of BTESA staff, with specialization in all systems related with Solid state RF power amplifiers:

- Radiofrequency: experience for reliable transistor circuits
- Software: for internal logic control system and remote control
- Electrical: we design our own power supplies, with special care for surge protection
- Mechanical: careful cooling extends lifetime

The skill of our R&D team to design any RF product, together with the flexibility of the System Engineering department to adapt to any project, allowed BTESA to easily jump in 2014 into the Industrial, Scientific and Medical Applications, complying their highest quality standards.

BTESA is your partner for power amplifier systems, either for design and manufacture of customized Solid State high power Amplifiers and drivers, or for a complete turn-key project, as well as for any manufacturing and testing requirement.

LARGE SCIENTIFIC FACILITIES AND NATIONAL RESEARCH FACILITIES CONTRACTS

[CERN] Design and manufacture of 2x RF Solid state power amplifiers 350kW pulsed power @ 101MHz (2022).

[ESS Bilbao] Design and manufacture of 3x RF Solid state power amplifiers 30kW pulsed power @ 352MHz (2021).

[ILS] Design and manufacture of RF Solid state power amplifier 156kW pulsed power @ 200MHz (2020).

[ESRF] Design and manufacture of 3x Driver 250W c.w. @ 352MHz 3RU (2020)

[ESS Bilbao] Design and manufacture of 7x Driver pulsed power 500W @ 352MHz 3RU (2020)

[F4E] Supply of 16 liquid cooled loads of 200kW c.w. power (2019).

[ALBA] Manufacture, supply and installation of sixteen (16) 80kW IOTs tubes at 499,654MHz and ten (10) trolleys with its auxiliaries for the ALBA Storage Ring RF transmitters (2018).

[ALBA] Design, manufacture, supply and installation of one 50kW RF high power transmitter based on Solid State Amplifiers @ 500MHz for the ALBA Booster synchrotron (SSA) (2018).

[ADAM] Design and manufacture of 5x Driver pulsed power 2kW @ 750MHz 4RU (2018).

[ALBA] Design and manufacture of 3x 600W driver @ 500MHz (2017).

[CERN] Manufacture and test of 180 Solid-State Power Radio Frequency (RF) Amplifiers 3kW @ 17MHz for the PS (Proton Synchrotron Accelerator) (2017).

[ESS] Design and manufacture of 2x 200W driver @ 704MHz (2017).

[CIEMAT] Design, Manufacturing and supply of 2x 16kW RF Solid State Power amplifiers at 175 MHz, for the Buncher cavities of the MEBT of the IFMIF/EVEDA Accelerator Prototype (LIPAc), presently under construction in Rokkasho (Japan) (2017).

[CERN] Design and manufacture of 11 drivers 1200W @ 704MHz pulsed Solid State RF Amplifiers for the MB-IOT test bench system for ESS (2016).

[European XFEL] Manufacture and supply of 250 power supplies for the superconducting magnets of the European X-Ray Free Electron Laser (2016).

[ALBA] Manufacture, supply and installation of 1 prototype and a series of 4 units of 80kW IOT tubes at 499,654MHz, with all their accessories, for the storage ring RF transmitters of ALBA synchrotron Light Source (2015).

R&D PROJECTS

ACTECA: 'ACCELERATORS AND RELATED TECHNOLOGIES FOR LARGE SCIENTIFIC FACILITIES" (2017-2021) Industrial R&D CDTI funded project (CIEN program), in a consortium of 7 companies

DONES-EVO: INDUSTRIAL RESEARCH IN TECHNOLOGIES AND PROCESSES APPLIED TO IFMIF-DONES IN ORDER TO EVOLVE IN THE FUSION PROGRAM" (2022-2025) Industrial R&D CDTI funded project (MISIONES program), consortium of 7 companies

MARKETS

Telecom & Broadcast

QUALITY CERTIFICATIONS, NUCLEAR QUALIFICATIONS

ISO 9001 / ISO 14001



350kW liquid-cooled SSPA for CERN

COMPANY NAME	BURDINBERRI, S.L.
ADDRESS	Calle Zorrostea, 4, 01010, Vitoria-Gasteiz
WEB	www.burdinberri.com
TURNOVER	4.703.241 in year 2021
EMPLOYEES	54 in year 2021
SME	YES
CONTACT PERSON	Jon Pardo Garate
	POSITION General Manager
	PHONE +34 945 242 300
	EMAIL burdinberri@burdinberri.com

COMPANY ACTIVITIES AND SKILLS

BURDINBERRI is dedicated to high quality machining and specialises mainly in the engineering, developing and fine-tuning metal tools for companies in sectors where technology is in great demand, such as aerospace, the automotive industry, nuclear energy, railways and the naval sector, among others.

BURDINBERRI has modern facilities, the most advanced design programs and the latest computer equipment for designing and developing its products, which allows it to cover a wide range of products, including designing and manufacturing them.

Burdinberri has two production centres and a variety of flexible machinery. 3- and 5-axis heads, high-speed palletising machines for serial processes and bridge type machining centres with a bed of up to 25 metres for precise, large-scale machining.

LARGE SCIENTIFIC FACILITIES AND NATIONAL RESEARCH FACILITIES CONTRACTS

[ITER – AVS] Machining and dimensional control of copper refrigeration panels (2022)

[ITER – AVS]] Machining and dimensional control of stainless steel (304L) spacers (2022)

[CLESSIDRA – AIRBUS] Tooling for manufacturing composite elementary parts (2021 -ongoing)

[ITER – ENSA] Machining of feed water distribution rings (2021 -ongoing)

[ITER – ENSA] Machining and NDT (VT, PT & DT) after reverse engineering of plugs as per drawings, step 2. Sectors 2, 3 and 9.(2021)

[ITER – ENSA] Cutting, machining and NDE of 3 spray box spray plates, items 14.004, 14.007 and 20.004, for pressuriser units 1 and 2. (2020 -ongoing)

[ITER – ENSA] 2CP38, 3CP38 and 9CP38 Machining and internal dimensional control of back plate. (2019)

[ITER – ENSA] 2CP34, 3CP34 and 9CP34 Machining and internal dimensional control of back plate. (2019)

[ITER – ENSA] 2CP64, 3CP64 and 9CP64 Machining and NDE. (2019)

[ARIANE – AIRBUS] Manufacture of automated assembly mandrels. (2018-2019)

[ITER – ENSA] Pre-machining, dimensional control and NDE of TSs. (2018)

R&D PROJECTS

MOLDITAN: Development and machining of moulds for super plastic forming of titanium rings. 2021.

ALAVA INNOVA: Feasibility study on the process for manufacturing Invar36 steel tools using laser technology.2021.

MOLDDUCTOS: Methodology for manufacturing carbon fibre ducts using a modular system. 2020.

MARKETS

Nuclear / Defense / Automotive / Naval / Aeronautics / Space / Energy

QUALITY CERTIFICATIONS, NUCLEAR QUALIFICATIONS

IISO 9001 / EN 9100:2018

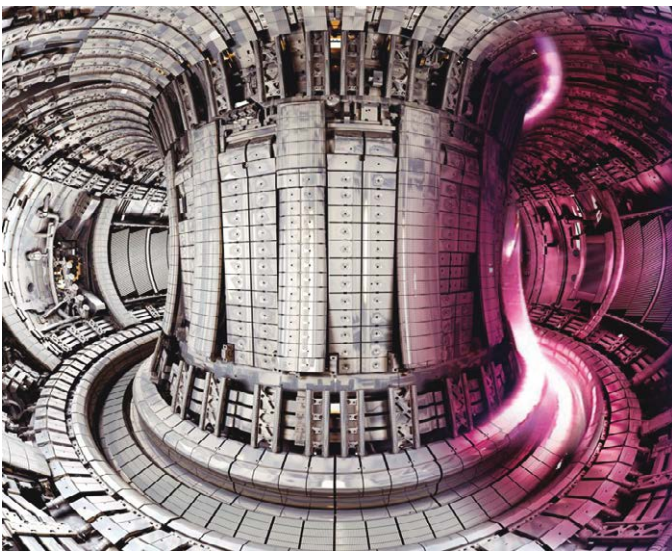

Tokamak.ITER (www.iter.org)

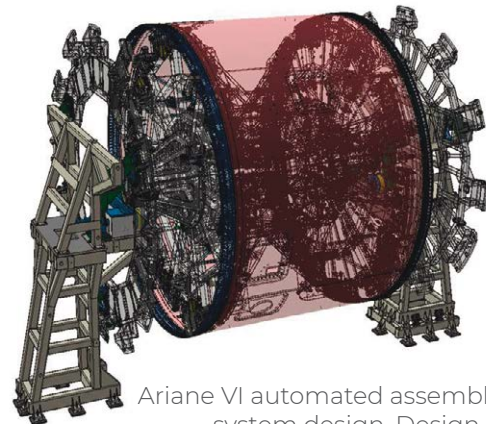

Ariane VI automated assembly system design. Design & Manufacturing.

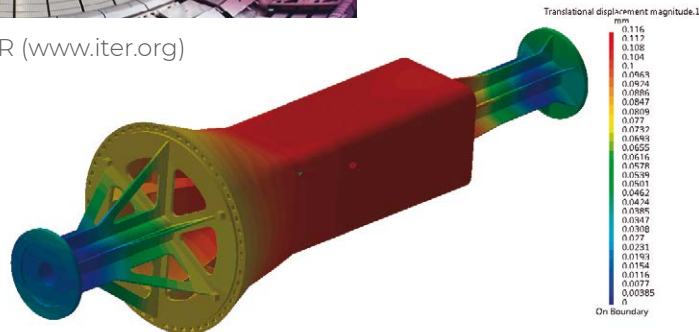

Clessidra dispenser curing tool FEM simulation. Design & Manufacturing.

COMPANY NAME	CADINOX SA
ADDRESS	Okobio 32, 20491 Belauntza, Gipuzkoa
WEB	www.cadinox.com
TURNOVER	12M€ In year 2021
EMPLOYEES	85 in year 2021
SME	YES
CONTACT PERSON	Peio Lakarta
	POSITION COMMERCIAL DIRECTOR
	PHONE +34 618329793
	EMAIL plakarta@cadinox.com

COMPANY ACTIVITIES AND SKILLS

CADINOX, since 1966 is specialized in the detail design, fabrication, testing, assembly and machining of integral mechano-welded products. Cadinox has a large experience manufacturing in complex Stainless steels, Carbon Steels and Aluminium .

Cadinox has many references in Vacuum Chambers (high vacuum) Cryostat and large and complex structures.

LARGE SCIENTIFIC FACILITIES AND NATIONAL RESEARCH FACILITIES CONTRACTS

- [LULI] Vacuum chamber for APOLLON (ongoing)
- [ESS - AVS] Connection ring (ongoing)
- [ESS- AVS] Monolith vessel cover (ongoing)
- [ESS- AVS] LOKI instrument (detector vacuum chamber & collimator) (2020)
- [ESS- AVS] Monolith vessel (2020)
- [LULI] Vacuum chamber for APOLLON (2021)
- [ELI - AVS] 2 aluminium vacuum vessel with optical table (2020)
- [ILL] Flight vacuum chamber for WASP (2018)
- [ILL] Flight vacuum chamber for H12 Phanter (2018)
- [IFMIF - CIEMAT] Beam dump structure + inside & outside cones (2018)
- [CERN] Cryostat 11T prototype (2017)
- [ELI] Laser experimental chamber (2017)
- [CLPU] Laser compressor and experimental chamber (2015, 2016)
- [CERN] HIE-SOLDE cryomodules (2013, 2015)
- [CERN] DTL tank and girder (2014)
- [CERN] NA 62 rich vessel (2014)
- [CERN] NA 62 straw stations (2014)

[ESRF] Small angle scattering beamline (SAXS) (2014)

[HZB] Neat detection chamber (2014)

[ESS] DTL tank (2014)

[ILL] IN16B vacuum chamber (2011)

[ILL] IN16B deflector chamber (2011)

[GRANTECAN] High precision Nasmyth rotators (2005)

MARKETS

Nuclear / Aeronautics / Space / Energy / Oil & gas

QUALITY CERTIFICATIONS, NUCLEAR QUALIFICATIONS

X ISO 9001 / X ISO 3834-2

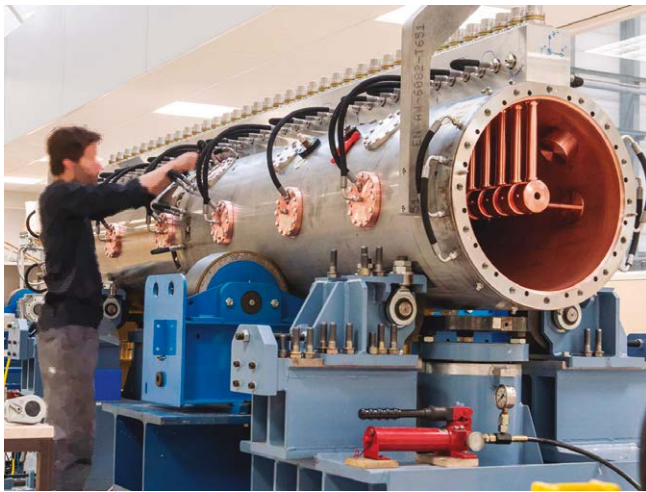

CERN dtl tank



ILL flight vacuum chamber for H12-panther



CERN RICH VESSEL NA62



ILL flight vacuum chamber for wasp

COMPANY NAME	CAPGEMINI ENGINEERING
ADDRESS	Avenida Diagonal, 199 08018 (Barcelona)
WEB	www.capgemini-engineering.com/es
TURNOVER	230M€ in year 2021
EMPLOYEES	+3900 in year 2021
SME	NO
CONTACT PERSON	Eugenio Pajuelo Lissén
	POSITION Team Manager
	PHONE +34 616 89 83 17
	EMAIL eugenio.pajuelo@capgemini.com

COMPANY ACTIVITIES AND SKILLS

CAPGEMINI ENGINEERING is a global leader in Engineering and R&D services that offers to its clients a new way to innovate by developing products and services of tomorrow. CAPGEMINI ENGINEERING works alongside clients on every link in the value chain, from conception to industrialization. For over thirty years, the Group has provided expertise to key players in Aerospace, Automotive, Defense, Energy, Finance, Life Sciences, Railway, and Telecoms sectors.

Our World Class Centers (WCC) bring the best of CAPGEMINI ENGINEERING to our clients worldwide. They develop offers & solutions in a specific domain (labs, technologies, methods, patents, certifications...) and leverage unique teams of experts.

Our experience includes a dedicated offer focused on engineering projects in the fields of scientific instrumentation, telescopes and scientific facilities and ground/on board instrumentation, highlighting our skills in mechanical and electro-mechanical design, opto-mechanical design, structural and thermal simulations, development of electrical and control systems and support to product manufacturing, integration and testing.

LARGE SCIENTIFIC FACILITIES AND NATIONAL RESEARCH FACILITIES CONTRACTS

[ESO - CESA] E-ELT M1 Segment Support System (2015)

[ESRF] Mechanical Drawing Works for the Source and the beamlines (2009)

[SAGEM- IDOM] Design of FM3 Support System (2008)

[ESO] E-ELT Enclosure Preliminary Design (2007)

[ESO] E-ELT Wind Experiment Breadboard, partnership with IAC and JUPASA (2005)

[ALBA] ALBA Synchrotron Vacuum Chambers Analysis (2004)

[GRANTECAN] Gran Telescopio de Canarias ELMER Mechanics (2003)

R&D PROJECTS

-E-ELT Composites. Structural ropes and composite materials for E-ELT altitude structure

-HERPLA. System for machining the support surface of the azimuth structure of a large

telescope.

-ECOSAT. Solar airship for observation and communications applications.

MARKETS

Defense / Automotive / Naval / Aeronautics / Space / Energy / Oil & gas

QUALITY CERTIFICATIONS, NUCLEAR QUALIFICATIONS

ISO 9001 / ISO 14001 / EN 9100, ISO 20000, ISO 27001, ISO 166002, PMI REP, DGAM

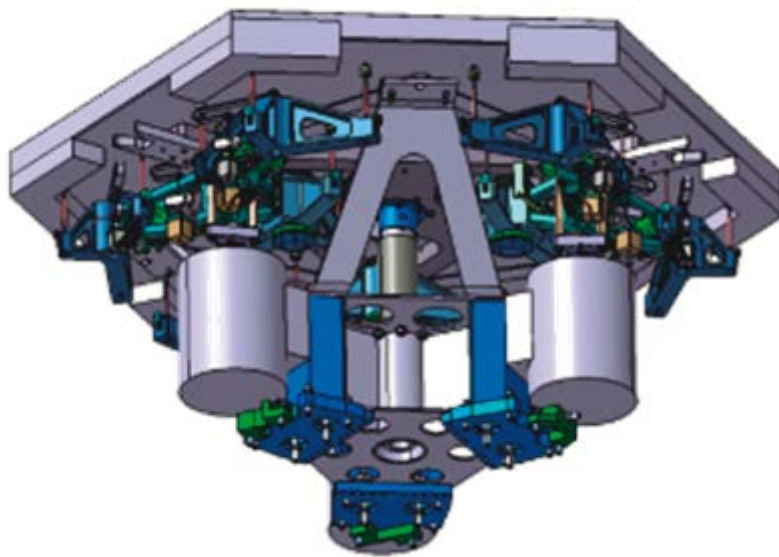

M1 Prototype Segment Subunit - Optomechanics



ELMER Mechanics



Wind Experiment Breadboard

COMPANY NAME	CBRE GWS TECHNICAL SERVICES S.L. (known before as SADES)
ADDRESS	Calle Doctor Trueta 113-119, 2nd floor, 08005 Barcelona (España)
WEB	www.cbre.es/es-es/servicios/lineas-de-negocio/global-workplace-solutions
TURNOVER	22M€ in year 2021
EMPLOYEES	130 in year 2021
SME	NO
CONTACT PERSON	Mateo Sánchez
	POSITION Technical Director
	PHONE 606.959.558
	EMAIL mateo.sanchez@cbre.com

COMPANY ACTIVITIES AND SKILLS

World-Class company experts in design, installation, commissioning and maintenance of HVAC, Fire Protection, Mechanical and Electrical systems.

In house engineering and technical department with strong capacities and capabilities qualified to develop any kind of project regardless its size or complexity, working with advanced modeling systems (BIM) and applying innovative technology solutions.

LARGE SCIENTIFIC FACILITIES AND NATIONAL RESEARCH FACILITIES CONTRACTS

- [CERN] HVAC systems for the High Luminosity Project (2022 +)
- [CERN] Framework ventilation (2022 +)
- [ICFO] ICFO WEST Building: Photonic Science Institute (2020-2022)
- [CERN] HVAC Primary mixed area East Area (2019-2021)
- [CERN] LINAC3 (2019-2020)
- [CERN] HVAC Building 156 (2019-2020)
- [CERN] HVAC Building 573-574 (2018-2019)
- [CERN] HVAC SFA181 (2018-2019)
- [CERN] Building 107 (2016-2018)
- [CERN] MEDICIS (2016-2017)
- [VHIO] CELLEX building (Oncological Research Center) (2014-2015)
- [CERN] Grey Rooms buildings 182 and 185 (2014)
- [CERN] Pressurization Interlock TCC8 (2014)
- [CERN] CERLAB Building (2014)
- [CERN] HVAC PS Accelerator (2012-2014)

R&D PROJECTS

[ICFO] HVAC nanofabrication electronic laboratory (2020-2022)

[CERN] HVAC manufacturing printed circuits building (2016-2017)

[VHIO] HVAC at animal facility (stable) for oncological investigation (2014-2015)

[CERN] HVAC Proton Sincrotron Accelerator (2013)

MARKETS

Nuclear / Energy

QUALITY CERTIFICATIONS, NUCLEAR QUALIFICATION

ISO 45001

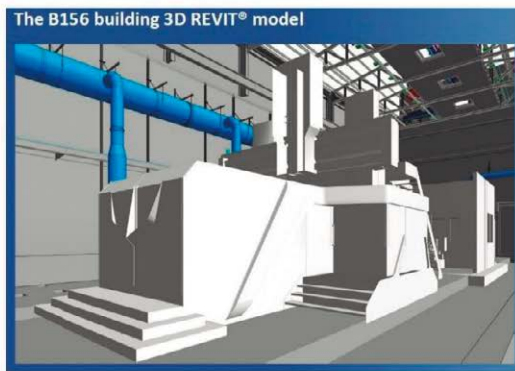

CERN Numeric control centre

COMPANY NAME	ASOCIACIÓN CENTRO TECNOLÓGICO CEIT
ADDRESS	Paseo Manuel Lardizabal 15, 20018 Donostia-San Sebastián
WEB	www.ceit.es
TURNOVER	20,5 M€ in year 2021
EMPLOYEES	243 in year 2021
SME	NO (Non-profit Research Centre)
CONTACT PERSON	Iñaki Yarza
	POSITION Corporate Development Manager
	PHONE 943 212800
	EMAIL iyarza@ceit.es

COMPANY ACTIVITIES AND SKILLS

Ceit is a nonprofit private research center with the mission to serve the industrial sector, carrying out projects of applied research and technological development. Ceit is a multidisciplinary center, whose work is oriented to different sectors: railway, aeronautical, automotive, health, manufacturing, energy, environment and ICT.

Ceit's capabilities and interests with regard to large scientific facilities are:

- Development of materials and components for extreme environments: graphitic materials, self-passivating W alloys, ODS Steels, porous silicon carbon with tailored porosity.
- Design, production and processing of powders. Equipped with metal/gas atomizer to produce tailored metallic powders for Additive Manufacturing or (Near) Net Shape Technologies
- HIP. Consolidation of ceramic and metallic powders, removal of porosity in castings or components obtained by Additive Manufacturing
- Laser-related technologies: additive manufacturing of components and surface treatments and micromachining
- Solid state diffusion bonding. Equipped with HIP press.
- Failure analysis: identification of failure mechanisms (mechanical and thermomechanical fatigue, corrosion, fractography analysis...)
- Electronic and magnetic NDT for microstructural characterization and identification of defects and cracks
- Physical, Mechanical and microstructural characterization (SEM, TEM, AFM)

R&D PROJECTS

[CDTI] Strategic program for excellence qualification in Additive Manufacturing of metallic materials (CEFAM) for highly demanding sectors, like Large Scientific Facilities, Aerospace or energy. (2020-2023)

[EUROfusion] Manufacturing and testing of SiC-based Flow Channel Inserts for the high temperature DCLL blanket. (2019-2021)

[EUROfusion] Additive Manufacturing of CuCrZr parts by Electron Beam Melting (EBM). (2019-2020)

[EUROfusion] Self-passivating tungsten alloys. (2014-2018) & (2019-2020)

[EUROfusion] ODS ferritic steels fabrication and characterization (STARS route). (2014-2018 & (2019-2020)

[F4E – Tecnalia] Material Characterization at room and elevated temperatures. (2016-2018)

[CDTI - HEDISA and Leading Metalmechanic Solutions] Solid state diffusion bonding of titanium and titanium alloys and development of complex stainless steel components following (Near) Net Shape technology, by powder metallurgy and HIP consolidation of powders. (2016-2018)

[F4E - Leading Metalmechanic Solutions] Supply of Full Scale Prototypes (FSP) of ITER Normal Heat Flux (NHF) FW Panels. (2015-2017)

[ESS-Bilbao] Assessment of the candidate tungsten bricks of the ESS target suppliers according to the tests protocol provided by ESS-Bilbao. (2015-2019)

[EUROfusion] Manufacturing and testing of SiC-based ceramics for Flow Channel Inserts in DCLL blankets. (2015 –2017)

[ComplTER, Government of Cantabria - Leading Metalmechanic Solutions] Development of a simplified 10-fingers prototype to design proper cutting strategies of the fingers of the FWP of ITER to mitigate distortions in the final component. (2015-2016)

[F4E - Leading Metalmechanic Solutions] Fabrication of a standard semi-prototype of the ITER NHF First Wall Panels (FWP). (2013-2014)

[F4E - Tecnalia]: Material Characterization at room and elevated temperatures. (2012-2014)

[CDTI - Leading Metalmechanic Solutions] Diffusion bonding of Be and CuCrZr by HIP, and microstructural characterization to evaluate quality of joints. (2012-2013)

[Spanish Ministry for Science and Innovation] Fusion Technologies Programme: Development and characterization of porous SiC and SiCf/SiC for application as Flow Channel Inserts in Dual Coolant Lead-Lithium Blankets. (2009 - 2014).

MARKETS

Automotive / Aeronautics / Space / Energy / Oil & gas

QUALITY CERTIFICATIONS, NUCLEAR QUALIFICATIONS

ISO 9001 / UNE 166.002 R+D+i Management Systems

Pilot plant gas atomizer to produce spherical powders





COMPANY NAME	Cuadros Eléctricos Nazarenos SL (CEN SOLUTIONS)
ADDRESS	Ctra. de la Esclusa s/n (Zona Franca) 41011 Sevilla (España)
WEB	www.censolutions.es
TURNOVER	24.959.597,69 € in year 2021
EMPLOYEES	220 in year 2021
SME	YES
CONTACT PERSON	Juan Pérez-Tinao Domínguez
	POSITION Head of Business Development
	PHONE +34 626 80 64 52
	EMAIL juan.perezтинаo@censolutions.es

COMPANY ACTIVITIES AND SKILLS

CEN Solutions was founded in 1994 to provide services to industrial and energy generation facilities, specializing in the design, manufacturing and services associated with:

- low and medium voltage electrical equipment, modular electrical rooms
- energy storage systems and equipment for all types of power facilities, petrochemical and industrial installations
- retrofitting services, modifications and preventive/corrective maintenance of existing equipment.

Company activities are focused on the following main markets: energy generation (fossil, nuclear and renewables), oil & gas, industries and electrical substations, water treatment plants, maritime sector, defense and aeronautical

The Services activity, associated with the Industry and Water business lines, provides electro-mechanical and automation solutions for processes, high value-added production lines and the water sector, providing immediate response, improvements, services and solutions to the customer's production processes and targeted to aeronautical facilities and water treatment plants.

We are currently erecting one of the largest facilities in Spain dedicated to the manufacture of electrical equipment, with a total of 30,100 m² and increasing the company capacities by 40%

LARGE SCIENTIFIC FACILITIES AND NATIONAL RESEARCH FACILITIES CONTRACTS

[ITER] – PBS26 TCWS SIC SIGNAL CONDITIONS CUBICLES (2022 – Ongoing)

[ITER] – Design and manufacturing SCS-N system (2013 – Ongoing)

[CERN] – DC Power Supply 0-5.400A, 1.800V (1993)

[CERN] - DC Power supply 0-20.000A, 17V (1991)

[CERN] – 2 DC Power supply 0-24.000A, 17V (1991)

[CERN] – DC commuted Power supply -10 --> +10V, -2.000 --> +2.000A (1991)

[CERN] – DC Power supply 0-20.000A, 25V (1990)

[CERN] – 40 AC Voltage Regulator 0-1.000A, 1.500kW (1987)

Collaboration with CERN started in the first stages of LHC, by the participation of the team with stances at site to work together during engineering phase prior starting manufacturing processes at our production center in Seville.

MARKETS

Nuclear / Defense / Naval / Aeronautics / Energy / Oil & gas

QUALITY CERTIFICATIONS, NUCLEAR QUALIFICATIONS

ISO 9001 / ISO 14001 / UNE EN 73401:1995, RCC-E UNE EN 9100:2018



Production center



SCS-N Qualification Cubicle

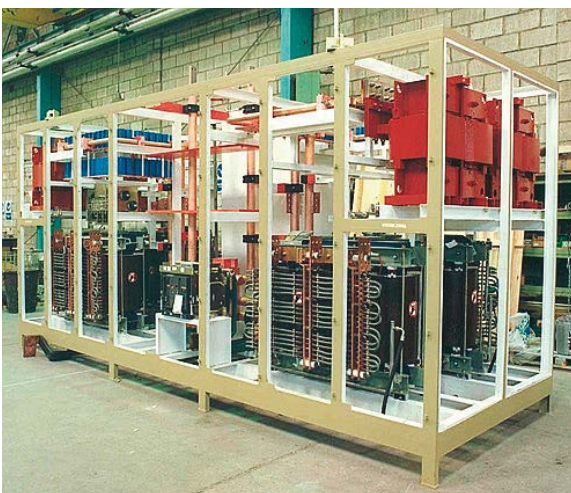

DC Power Supply for CERN

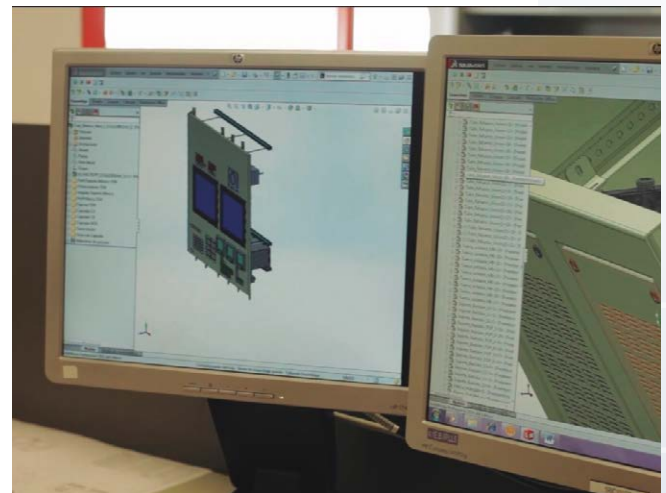

Mechanical engineering

COMPANY NAME
ADDRESS

CiTD Engineering & Technologies, S.L. (CiTD)
Avda. Leonardo da Vinci, 15. Edificio B, 2ª planta.
28906 Getafe (Madrid). Spain

WEB
TURNOVER
EMPLOYEES

www.citd.eu
2.985.460 in year 2020
51 in year 2021

SME
CONTACT PERSON

YES
Marta García-Cosío Carmena

POSITION Head of Aerospace and Product Business Unit

PHONE 00 34 609 94 04 74

EMAIL marta.garcia-cosio@citd.eu

COMPANY ACTIVITIES AND SKILLS

CiTD, the former ITD, is a company headquartered in Getafe, close to Madrid, with presence in the market for more than 20 years. Its experience is largely related to aerospace/aeronautics programs, being one of the leading engineering companies in the Spanish industry. Its expertise embraces most of the engineering and design technologies also applicable for the development of Large Scientific Facilities Activities. As an engineering company, with a core business in Electrical & Mechanical Systems, Structural Design & Analysis, and Instrumentation, its added value is based on the transnational management capabilities and the long experience in the development of international projects in highly technological environments.

Since 2017, its portfolio is being open to infrastructures and digital transformation (Industry 4.0) thru Digital Twin and BIM technologies as well as offering final products involving turnkey services/projects via one-stop-shop concept thru a consolidated supply chain scheme. In this line CiTD is boosting metal additive manufacturing technologies on flyable certified parts for aerospace, supported by topological optimization engineering and R&D projects. It is also offering supply capabilities for: electrical harnesses, tooling and parts in general for a wide spectra applications, especially in composites (monolithic or sandwich).

LARGE SCIENTIFIC FACILITIES AND NATIONAL RESEARCH FACILITIES CONTRACTS

[IAC-EST] Heat Rejecter Preliminary Design for the European Solar Telescope (2022-2023)

[F4E] Framework Services Contract in Cascade for the Provision of CAD design support services (2021-2024)

[F4E] Framework Services Contract in Cascade for the Provision in the field of General Mechanical Engineering Design Analysis (2018-2021)

[CERN] Framework contract for the Provision of Mechanical Design Services On and Off the CERN Site (2013-2018).

[F4E] Competitive Multiple Framework Service Contract: Provision of CAD Design Support for General Mechanical Design" (2013-2016).

[F4E] Industrial Cost Evaluation and Scheduling of the Cooling Plant for PRIMA (MITICA and SPIDER Experiments) (2010)

R&D PROJECTS

COMSENSO: WAAM technology laser-assisted for SENSORized multimaterial COMponents (Misiones Ciencia e Innovación-CDTI). (2022-2024)

ZERO: technologies for a Zero Emission aiRcraft Operation (PTA). (2022-2023)

AM4ALL: Additive Manufacturing For the Spanish Space Industry (ESA-GSTP). (2021-2022)

COMPIAE: new Integrated COMposite manufacturing process for Electric Aircraft (PID-CDTI). (2020-2021)

CUBAM: Cubesat Additive manufacturing and Metalization best practice application experiment (AMable OC4-H2020). (2020-2021)

WAAMEM: WAAM Engine Mount Feasibility Study (AMable OC3-H2020). (2020-2021)

DIGESTAIR: Anaerobic plant in air transport for on-board waste treatment (Clean Sky 2). (2019-2021)

PAMIS: Personalized Additive Manufactured Implants for Scoliosis treatment (H2020). (2018)

FASE: Additive Manufacturing for Space Sector (Retos-Colaboración, MICINN). (2018-2021)

Novel structural components for launchers/satellites applications using additive manufacturing technologies (ESA-GSTP). (2019)

MARKETS

Nuclear / Defense / Naval / Aeronautics / Space / Oil & gas / Mechanical Engineering and Infrastructures

QUALITY CERTIFICATIONS, NUCLEAR QUALIFICATIONS

ISO 9001 / ISO 14001



Composite bulkhead



ESA-AM bioinspired satellite bracket



Compieae



COMPANY NAME	COMET INGENIERIA S.L.
ADDRESS	C/ Convento Carmelitas, 2, of.2, 46010 Valencia (Spain)
WEB	www.comet-ingenieria.es
TURNOVER	1,5 M€ in year 2021
EMPLOYEES	25 in year 2022
SME	YES
CONTACT PERSON	Ángel Sierra Hernández
	POSITION Business Development Manager
	PHONE (+34) 660 470 440
	EMAIL asierra@comet-ingenieria.es

COMPANY ACTIVITIES AND SKILLS

Engineering:

- Design: mechanical components, structures, mechanisms, machines, and tooling
- Analysis: statics, dynamics, kinematics, thermal, fatigue, fluid-dynamics, vibro-acustics.

Manufacturing:

- Prototypes, short product series, ad hoc machines, production/testing tooling
- Metals (steel, aluminium, titanium, special alloys), composites (CFRP, glass fiber, etc.)

LARGE SCIENTIFIC FACILITIES AND NATIONAL RESEARCH FACILITIES CONTRACTS

[ESA] 4000116156/15/NL/PS: Modular Deployable Structures (2016)

Development of a reliable deployable unit cell that can be used to compose several kind of space structures, i.e., a large deployable mast (20 meters) and a large deployable reflector (15 meters diameter). Expected final TRL achieved: 4

[ESA] 4000114438/15/NL/CBi/GM: Passive Damped Deployment of full Composite Structures (2015)

Research and development of the use of flexible epoxy resins in order to deploy full CFRP structures. These structures are composed of thin-walled composite deployable booms with CFRP tape-spring hinges. This flexible epoxy resin can be used to increase both the flexibility and damping characteristics of the CFRP, and has a potential number of space applications. Final TRL achieved: 3

[ESA] A00011082: Assembly of Space CFRP structures with racing sailing boats technology – (2011)

50 K€. Innovative project devoted to apply the out-of-autoclave CFRP curing techniques coming from the racing sailing boats technologies to space composite products, by means of analyses and tests. Final TRL achieved: 4

R&D PROJECTS

[ESA] 4000116156/15/NL/PS: Modular Deployable Structures (2016)

[ESA] 4000114438/15/NL/CBi/GM: Passive Damped Deployment of full Composite Structures (2015)

[ESA] A00011082: Assembly of Space CFRP structures with racing sailing boats technology – (2011)

MARKETS

Defense / Automotive / Naval / Aeronautics / Space / Energy / Railways / Manufacturing industry

QUALITY CERTIFICATIONS, NUCLEAR QUALIFICATIONS

ISO 9001 / EN 9100



Deployable Reflector Structure Demonstrator

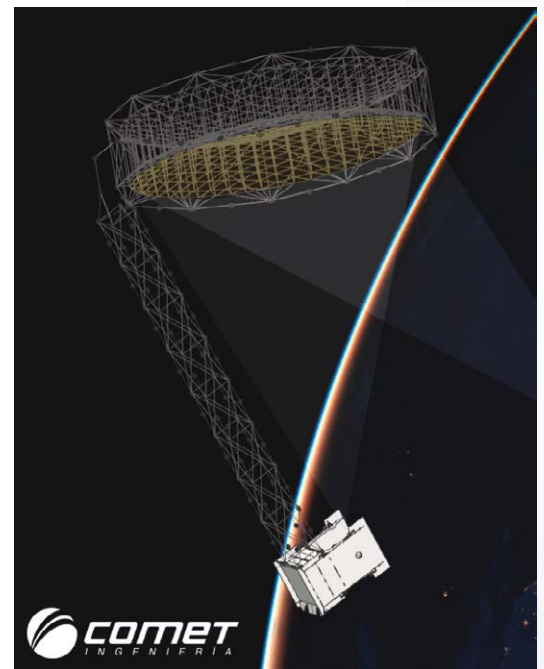

Large Deployable Antenna

COMPANY NAME	CRISA
ADDRESS	Calle Torres Quevedo, 9 (PTM)
WEB	www.crisa.es
TURNOVER	73 M€ in year 2021
EMPLOYEES	496 in year 2021
SME	NO
CONTACT PERSON	Juan Jesús Rico Peña
	POSITION Key Account Manager
	PHONE (34) 91 806 8808
	EMAIL juanjesus.rico@airbus.com

COMPANY ACTIVITIES AND SKILLS

Crisa, an Airbus company, is a well renowned supplier of complex on board electronics for space. More than 36 years' experience, around 500 employees and more than 1.200 electronic units flown into space back Crisa's capabilities in the design and manufacturing of complex electronic equipment for satellites and launchers. The company's activities cover a wide product range like system engineering, power distribution units, power control units, DC/DC converters, active antenna electronics, cooler electronics, launcher electronics, driving electronics, electrical propulsion electronics, front-end electronics, on board computers, remote terminal units, video processing, microelectronics or antenna driving.

Crisa has played a relevant role in most ESA's scientific or Earth Observation missions (ie. BepiColombo, Cheops, EarthCARE, Euclid, GAIA, GOCE, Herschel/Planck, LISA Pathfinder, Mars and Venus Express, MetOp, MTG, PAZ/Ingenio, Pleiades, Rosetta, Sentinels, SolarOrbiter, ...), many Telecommunication programs for Commercial Operators (platforms AlphaBus, Eurostar E3000, OneSat, Quantum and SmallGEO) and NASA scientific missions (ie. Rover Curiosity – MSL, Rover 2020 to Mars). At the moment, the company is working on important scientific missions and programs like JUICE, Ariane 6 and Vega C launchers, Copernicus Expansion missions, Mars Sample Return or Lunar Gateway HALO.

Crisa has expanded its engineering and project management skills in other ground projects. Some of these projects include network architecture design for secure communications; control center implementation, operation and maintenance; archiving and cataloguing systems; remote operation. Crisa is able to provide reliable electronics designed for harsh environments like space or fusion under radiation and no-maintenance conditions. The company has also a strong knowledge of system engineering and project management.

LARGE SCIENTIFIC FACILITIES AND NATIONAL RESEARCH FACILITIES CONTRACTS

[ESA] Equipment for European Space Agency (ESA) missions: Electrical Power Subsystem (EPS) for JUICE mission to Jupiter, Electric Propulsion Power Processing Unit (PPU) and Power Conditioning and Distribution Unit (PCDU) for BepiColombo mission to Mercury, GOCE PCDU & Electric Propulsion IPCDU, On Board Computer for 2020 ExoMars Rover NASA mission to mars or PPU and PCDU for Mars Sample Return Earth Return Orbiter mission, among many other contracts with ESA.

[NASA] Power Management and Distribution (PMAD) for NASA's lunar Gateway Crisa will provide the standard modular power management system of HALO (Habitation and Logistics Outpost) for the Moon-orbiting Gateway, as part of NASA's Artemis programme to return to the Moon.

[ISS] Electronics for High Energy particle Physics. Design and manufacture of the Cryo-magnet Avionics Box (CAB), which provides power and monitors a superconducting dipole magnet, part of the Alpha Magnetic Spectrometer (AMS-02). The AMS was the first large superconducting magnet in space with application in radiation protection, propulsion system, power generation and energy storage. Project conducted under the technical supervision of CIEMAT, with funding provided by CIEMAT, CDTI and ETH-Zurich.

[ITER] CODAC Engineering Support Framework contract for Control & Data Acquisition Communication Systems (CODAC) and heating Current Drive division. Contract ref.: ITER/CT/6000000014.

R&D PROJECTS

Some of the most recent R&D projects:

- Development of High Power PCDU (Power Conditioning and Distribution Unit) for low orbit high power satellites, compliant to any Solar Panel Interface and Bus Voltage.
- High quality and reliability modular Instrument Control Unit (ICU) with flexible architecture.
- Design, integration and verification of High Voltage elements for satellite Electric Propulsion Systems, covering HET (Hall Effect Thruster), GIT (Gridded Ion Thruster) and HEMP (Highly Efficiency Multistage Plasma Thruster) technologies.
- Lead-free automatic manufacturing line for aerospace electronics.
- Optimized low-cost electronics for Mega Constellations

MARKETS

Nuclear / Defense / Space

QUALITY CERTIFICATIONS, NUCLEAR QUALIFICATIONS

ISO 9001, ISO 14001, PECAL/AQAP 2110, ECSS-Q-ST-70-38C, 08, 28, 38&26



Class-100 clean room



Manufacturing of space proven electronics



**ENGINEERING
DRIVEN
PEOPLE**

COMPANY NAME	CT INGENIEROS
ADDRESS	Avda. Leonardo da Vinci, 22. Parque Empresarial La Carpetania. 28906 Getafe (Madrid, Spain)
WEB	www.thectengineeringgroup.com
TURNOVER	117M€ in year 2021
EMPLOYEES	1700 in year 2021
SME	NO
CONTACT PERSON	José Evelio Jiménez
	POSITION Country Manager for Spain
	PHONE +34 91 683 20 30
	EMAIL jjimenez@ctingenieros.es

COMPANY ACTIVITIES AND SKILLS

The CT Engineering Group provides engineering services to the aerospace, naval, defence, automotive, rail, industrial plants, energy, architecture and construction sectors, covering the entire product life cycle: from design, product and manufacturing to post-sales support engineering. With more than 30 years of experience, technical expertise and 1,800 engineers, we adapt to exceed the clients' expectations. CT has more than 20 offices mainly in Europe (Spain, France Germany and UK), Brazil and India. CT has been involved in several projects for the nuclear sector during the last 10 years, with more than 100.000 hours in projects such as ITER, East Anglia, CERN or F4E. Additionally, CT is a preferred supplier for product engineering services (E2S), manufacturing engineering services (ME3S) and Customer Services (CS) to the Airbus Group, a preferred supplier of engineering for Navantia, Tier 1 for GDELS, as well as in the automotive sector in Nissan, Renault, SEAT and Audi facilities, in the rail sector, with Talgo and in industrial plants, with Repsol and CEPESA.

LARGE SCIENTIFIC FACILITIES AND NATIONAL RESEARCH FACILITIES CONTRACTS

[Scottish Power] Saint Briec Offshore Project. (2020- present): complete design for the SCADA and Communication System of the project, including basic and detailed engineering, FAT and SAT, and customer support during onshore and offshore commissioning processes.

[SABIC] Field Planner and Reliability Engineering Services at SABIC plant in Cartagena (2019 - present): Product Support Engineering to perform maintenance, planning and monitoring activities at SABIC's plant, including collaboration on Reliability Engineering Services for all the Maintenance 4.0 activities.

[Iberdrola] EAST ANGLIA ONE Project. (2017- 2020): Engineering services during the commissioning process of the offshore substation. Collection of information of the different systems by using SCADA system as well as the control and functional tests performed during both onshore and offshore commissioning processes.

Arturo Merino Benítez (AMB) International Airport in Santiago de Chile (2017- present). façade and roof engineering for the enlargement of the new passenger terminal of AMB airport in Santiago by using BIM methodology.

[TAMOIN] Kimberly and Clarke in Querétero Mexico (2016 - 2017). Civil, structural, piping

and electrical detailed engineering design of a Cogeneration Plant developed by Iberdrola and Tamoin. Design of the interconnection between the cogeneration and the existing Plant.

[ITER – Siemens, Ferrovial] Integration and redesign of the substations PBS41 and PBS43 (2015 - 2021). Integration and redesign of the existing engineering on the 22 kV and 6,6 kV substations of the American part (PBS43). Complete integration of all the different parts (400 kV, 66 kV, 22 kV and 6,6 kV) in the two huge substations of the project, the American one (PBS43) and the Chinese one (PBS41). We have already energized the substations of the American, 400 kV, 22 kV & 6,6 kV Substation (PBS43) as well as the Chinese 400 kV Substation (PBS41) and delivered all schematics of Chinese Substations (PBS41).

[SEAT Martorell] (2015- 2020). 3D by laser scanning point clouds and modelling of all the facilities and work sites. Engineering and project management for the foundations of presses, automated warehouses and structural reinforcements.

R&D PROJECTS

KIRIBATI (2019-2020). Smart Platform for Electrical Powertrain evaluation and control. The platform gathers data from sensors equipped in the system to be studied and processes and sends the information to KiribatiApp. The platform will be designed as sensor-agnostic element to allow the solution to be flexible to other operational environments.

TOKAMAK (ITER) (2017-2019). Collaboration with CIEMAT in the mechanical design of the visible and infrared spectrum diagnostics system of the Tokamak nuclear fusion reactor. Design of the system for assembly and regulation of the optical elements and diagnostics system. During 2016- 2017, CT has had an expert in complex CFD calculations working on Tokamak's cooling system at the ITER facilities in Cadarache.

CEA Caradache. Experimental installation on the hydro-mechanical behavior in a nuclear reactor (2016-2017). CT participates in this R&D project providing a mechanical tool to manipulate hydraulic tensile tool in Laboratory. The scope of the project concerns an experimental installation on the hydro-mechanical behavior in a nuclear reactor.

MARKETS

Nuclear / Defense / Automotive / Naval / Aeronautics / Space / Energy / Oil & gas / Rail, Architecture & Construction

QUALITY CERTIFICATIONS, NUCLEAR QUALIFICATIONS

ISO 9001 / ISO 14001



Iberdrola substation installed at german Wikingen offshore wind farm. Photo Iberdrola



The very high voltage electrical substation on the south side of the platform (Photo IO EJP Richie)



D+T Microelectrónica, A.I.E.

COMPANY NAME	D+T MICROELECTRÓNICA A.I.E.
ADDRESS	C/ Til·lers, UAB Campus, Cerdanyola del Vallès, 08193 Barcelona (Spain)
WEB	www.dtm.es
TURNOVER	758 k€ in year 2021
EMPLOYEES	20 in year 2021
SME	NO
CONTACT PERSON	Manuel Lozano
	POSITION Director
	PHONE +34 935947700
	EMAIL manuel.lozano@csic.es

COMPANY ACTIVITIES AND SKILLS

D+T Microelectrónica A.I.E. is an Association of Economic Interest in charge of the commercial exploitation of IMB-CNM's Micro-nano fabrication Clean Room. Its mission is providing industry and scientific research with turnkey solutions based in microelectronics technology.

We put our facilities and our expertise at your service. We can run single processes in order to test and optimize your technologies, fabricate and characterize prototypes to study feasibility of your new ideas or managing pilot series and/or final production of your devices.

Our experience spreads in different markets, from Industrial and quality control to healthcare and medical technology, from big science experiments to space applications.

Our activity in Large Scientific Facilities mainly focuses in radiation detectors for High energy Physics and Synchrotron applications and SiC power devices for satellites and other harsh environments (radiation and temperature).

LARGE SCIENTIFIC FACILITIES AND NATIONAL RESEARCH FACILITIES CONTRACTS

[ALBA] Silicon detector fabrication (2021)

[CERN] Fabrication of Si dummy chips/sensors (2020-2021)

[SLAC] Processing of Microstrip Detectors (2020-2021)

[CERN] Silicon Heaters (2020)

[ESA] Custom test bench to stress test components (as per the Agency's Statement of Work "MOSFET reliability test system") (2019-)

[SLAC] Prototype radiation detectors with microstrip patterns (2017)

[DESY] Fabrication of dummy pieces of the ABC130 chip for the ITk Collaboration (2017-2019)

[CERN] Strip sensors made of N-rich Silicon (2016)

[DESY] Radiation detector fabrication (2016)

- [ESRF] Processing of SiC wafers (2016)
- [CERN] Development of Gallium doped LGAD (2016-2020)
- [CERN] Fabrication of dummy pieces of the ABC130 chip for the ITk Collaboration (2015)
- [DESY] Prototype sensor fabrication (2012)
- [CERN] Fabrication of 3D ATLAS FE-I4 detectors (2011-2013)
- [ESA] SiC diodes for the BepiColombo satellite solar panels (2011-2013)
- [CERN] Thin-glass fan-in fabrication (2009)
- [ESA] Power and thermal management of wide bandgap semiconductors (2007-2009)
- [ESA] Solar Array HT SiC Blocking Diodes (2007-2009)
- [ESA] Packaging of SiC-Schottky and SiC-JBS diodes (2007)
- [CERN] Fanin (Pitch adapters) procurement for ATLAS SCT (2006)

R&D PROJECTS

- [DESY] Cooperation agreement to develop micro-channel cooling for detectors (2020)
- [ESRF] Study of feasibility for the development of linear mode avalanche Photodiodes (2010)

MARKETS

Nuclear / Space / Particle Physics, Synchrotron

QUALITY CERTIFICATIONS, NUCLEAR QUALIFICATIONS

Radioactive facility licence

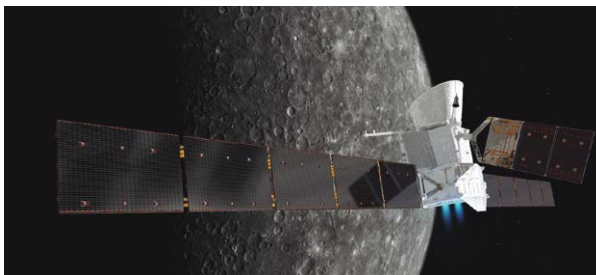

ESA BepiColombo satellite with the solar panels unfolded

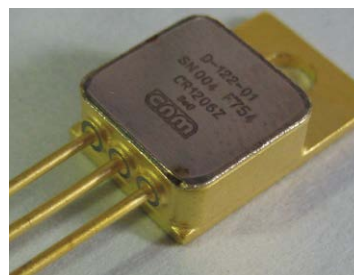

Pacakaged SiC blocking diode

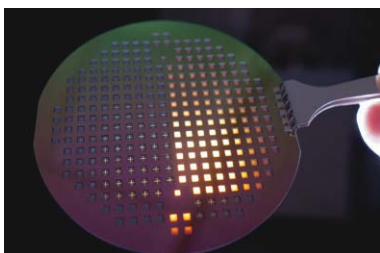

One and four quadrant 10 micron thick silicon diode for synchrotron beam monitoring

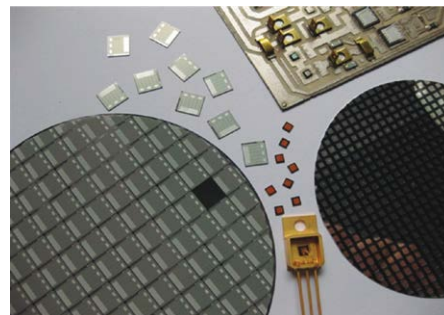

Silicon Carbide (SiC) diodes

COMPANY NAME	DAS PHOTONICS, S.L.
ADDRESS	Camino de Vera, s/n, Edificio 8F, 2ª Planta, 46022 Valencia
WEB	www.dasphotonics.com
TURNOVER	5.5M € in year 2021
EMPLOYEES	102 in year 2021
SME	YES
CONTACT PERSON	Delfín Rodríguez Mínguez
	POSITION Business Development Director
	PHONE (+34) 677 621 524
	EMAIL drodriguez@dasphotonics.com

COMPANY ACTIVITIES AND SKILLS

DAS PHOTONICS was created in 2005 as a spin-off company from the Nanophotonic Technology Centre (NTC - Polytechnic University of Valencia, <http://www.ntc.upv.es/>), focused on the development of innovative value-adding products based on our proprietary photonics technology. Our products are at the forefront of R&D in Photonics for Space, Defence, and Aeronautics. DAS is recognized internationally as a leading company in the field of RF-photonics for Defense and Space applications. The company exploits the advantages of photonics technology to offer solutions with improved bandwidth, mass and power consumption, compared with electronic/RF implementations.

For Space, DAS develops solutions for both, ground segment and on-board systems, exploiting the benefits provided by photonic technology, such as significant mass, size and power consumption reduction, instantaneous bandwidth (from near DC to above 40 GHz) phase stability, long transmission distance as well as EM immunity. The current applications developed by DAS Photonics are in the line of photonics links for digital and analogue signals remoting, multi-frequency conversion and antenna beamforming.

LARGE SCIENTIFIC FACILITIES AND NATIONAL RESEARCH FACILITIES CONTRACTS

[ESA] 4000120740/17/NL/AI 2017 Optical Harness for Future L-band Radiometer (2017)

[ESA] 4000122614/17/NL/FG Single String Photonic Payload (SSPP) and Multi String Photonic Payload (MSPP) (2017)

[ESA - INTA] Exomars Proposal for the development of the RAMAN laser unit (2013)

[ESA] AO/1-6034/09/F/MOS - Future Architecture of ESA Deep Space Stations for Enhanced Mission Support. Reference: GRST-SYST-GST-SOW-1002-OPS-GSS (2009)

[ESO] Front End Integration Centre Local Oscillator Photonic Reference Synthesizer Test Module (LOTRM) (2008) Generation of mm-Wave LO by using photonic harmonic conversion techniques (27.3 GHz till 124.34 GHz) in order to be used as test equipment for validating the ALMA radiotelescope front-ends (Atacama, Chile) – Reference 19766/ESO/08/17259/YWE

R&D PROJECTS

[ESA] ARTES 5.1. AO/1-5395/07/NL/EM -2012- Optical Multi-Frequency Conversion Unit for Broadband Transparent Analogue Repeaters

[ESA] ARTES 5.2 & ARTES 3.4. -2011 -IoV - Optical RF distribution Flight Demonstrator

[ESA] ARTES 5.1. -2011 - Opto-Microwave Wideband Reconfigurable Receiver

[ESA] TRP AO/5809/08/NL/CP - 2009 - Electro-photonic ADC

... up to 18 ESA projects (TRP, GSTP, GSP, ARTES, ...)

MARKETS

Defense / Aeronautics / Space

QUALITY CERTIFICATIONS, NUCLEAR QUALIFICATIONS

ISO 9001 / AQAP 2110 / ISO 9100

Photonic RF analogue link for space applications

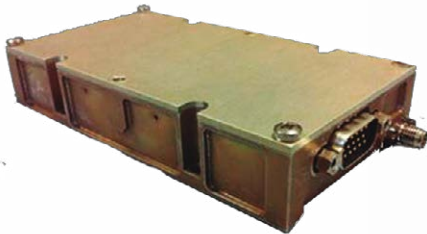

Rack mounted photonic RF analogue link up to 40 GHz



Ruggedized RF optical delay line



RF optical delay line



QV-band photonic multi-frequency converter flying in EUTELSAT 7C



COMPANY NAME
ADDRESS

DEIMOS SPACE
Ronda de Poniente 19 Edificio FITENI VI,
28760, Tres Cantos, Madrid, España

WEB
TURNOVER
EMPLOYEES
SME
CONTACT PERSON

www.deimos-space.com
36,218,557.34 in year 2020
469 in year 2021
NO
Lucía Senchermés Cháfer
POSITION Business Developer
PHONE +34 918 063 450
EMAIL lucia.senchermes@deimos-space.com

COMPANY ACTIVITIES AND SKILLS

At Elecnor Deimos we provide high-technology engineering solutions, information systems, products and services of maximum quality, innovation and added-value to its customers.

In Space our areas of expertise include systems engineering, ground segment, mission analysis and design and onboard software solutions, as well as satellite integration, in the fields of Science and Exploration, Satellite Navigation, Earth Observation, Space Situational Awareness, and Launchers.

We also develop turnkey operational systems for aeronautical and maritime applications, both civil and military, including UAV systems and solutions. Additionally, we provide services for the transport sector, applications for the optimisation of industrial processes, digital transformation solutions and location-based services.

LARGE SCIENTIFIC FACILITIES AND NATIONAL RESEARCH FACILITIES CONTRACTS

[DEIMOS SKY SURVEY] Implementation and Upgrades of SST Telescopes and Processing Centre (2015-2017)

[ESA] Spanish Space Surveillance and Tracking System (S3T): Data Centre Catalogue Generation (2015-2017)

[ESA] SEISOP, Space Weather Prediction System (2011)

[ESA, CDTI, DEIMOS] Various SST Object Cataloguing Campaigns based on Optical Observations (2006-2014)

R&D PROJECTS

[H2020] SWAMI: Space Weather Atmosphere Model and Indices

[FP7 & H2020] NEOShield (1 & 2) 2 - Near-Earth Object Impact Mitigation & Prevention, 2012 & 2015

[ESA] Sentinel-3 Instrument Processing Facility, 2012 (example of the many references in data processing systems)

[ESA] DCII – SSA Data Centre Processing Chain and Sensor Simulator, 2012

[ESA] SN-VII NEO Impact Effects and Mitigation Measures, 2011

MARKETS

Defense / Naval / Aeronautics / Sapce / ICT Solutions, Railway, Passenger Information Systems

QUALITY CERTIFICATIONS, NUCLEAR QUALIFICATIONS

ISO 9001 / ISO 14001/ PECAL/ACAP 2110



Deimos Ground Station
- Elecnor Deimos -
Integration of the 10 m
TTC Ground Station for
Deimos-2 Satellite, 2013

COMPANY NAME	DRAGADOS, S.A.
Address	Avenida del Camino de Santiago, 50, Madrid. Spain
WEB	www.dragados.com
TURNOVER	4,518 Million euros in year 2020
EMPLOYEES	10,680 in year 2020
SME	NO
CONTACT PERSON	Manuel Pardo Moreno POSITION International Business Development Manager
	PHONE +34 (91) 703.84.77
	EMAIL mpardom@dragados.com

COMPANY ACTIVITIES AND SKILLS

DRAGADOS, S.A and its group of companies form part of ACS Group Construction Division. ACS Group appears in 2021 ENR Global Construction Book as the 10th largest International Contracting Group with a total annual turnover of 34.94 Billion € in 2020 and the 1st International Contractor.

DRAGADOS, S.A. is nowadays one of the largest Construction Contractors in Spain and has been present in the international markets during more than 40 years, working in different and important projects, and some of them have reached great worldwide acknowledgement.

DRAGADOS, S.A and its Subsidiaries have more than 10,000 employees, 11 Branches in Spain and it has offices in Poland, Ireland, United Kingdom, USA, Canada, Chile, Argentina, and Peru. In all these countries, DRAGADOS, S.A. carries out its activities in the Civil Works field (from Transportation Infrastructures, Hydraulic and Underground Works to Marine Works or Environmental Infrastructures). DRAGADOS is also working in the Vertical Building Sector.

DRAGADOS, S.A. has carried out some outstanding projects all over the world:

Civil Engineering Works: Roads, Highways (more than 12,000 km executed), railways and subways (5,000 km constructed), bridges (more than 2,000 Km), hydraulic works (more than 250 dams), airports (4 million m² of runways and 1.2 million m² of Terminals), industrial installations, marine works (more than 300 km of breakwaters and wharves), urban planning, sewage systems and power plants.

Vertical Building Works: Apartment and Commercial buildings, Tourist Resorts, Industrial Buildings, Sport and Cultural Facilities, Restaurants, Office Complexes and Car Parks (more than 3,642 building projects).

The experience, human resources, technical capability and financial solidity of DRAGADOS enables it to deal with any project regardless of its complexity or size.

As a major international contractor, DRAGADOS has extensive experience working on challenging projects, including complex building and tunneling projects during all the phases of the project: since first analysis to the process of selection of subcontractors, complying with all contractual requirements for the different materials.

DRAGADOS is a specialist in the construction of buildings for clients that seek the best result for their proposed structures, require strict construction schedules, the application of new project-specific construction technologies, and high quality facilities and finishes all under the guideline of a sound quality and project management program.

DRAGADOS provides its Clients with its management experience on major construction as well as its deep knowledge of every phase of building process, especially regarding the coordination and inspection of the different suppliers and subcontractors. DRAGADOS also offers to its Clients an integrated management system where quality, environment, community and safety are addressed in an interrelated approach. DRAGADOS provides the required expertise to be ISO 9000 and ISO 14000 compliant and implements ISO45001.

In 2016, DRAGADOS obtained the Certificate of Energy Management System issued by AENOR according to UNE-EN-ISO-50001. In 2018 DRAGADOS obtained the "Certificate of Information management for the capital/delivery phase of construction projects using building information modelling" in accordance with ISO 19650-1:2018, ISO 19650-2:2018 including UK National Annex and BS 1192-4:2014 issue by BSI Assurance UK Limited.

LARGE SCIENTIFIC FACILITIES AND NATIONAL RESEARCH FACILITIES CONTRACTS

- LHC - Civil Engineering Construction, Package 2 - Contract T053/ST/LHC at Point 5 (CMS), Cessy (France) / C.E.R.N. - European Organization For Nuclear Research / 2005
- Ascó Nuclear Power Plant Units I and II / Refrigeration and Water Discharge Enlargement in Ascó, Tarragona (Spain) / Ascó Nuclear Association / 1995
- Nuclear Power Plant in Trillo, Guadalajara (Spain) Unión Fenosa / 1988
- Vandellós Nuclear Power Plant Group II Civil Works in Vandellós, Tarragona (Spain). / Ascó-Vandellós II Nuclear Association / 1985
- Refrigeration Towers (Natural flow) for Trillo Nuclear Power Plant Group I in Trillo, Guadalajara (Spain). / Unión Fenosa / 1983
- Almaraz Nuclear Power Plant Civil Works in Almaraz, Cáceres (Spain). / Almaraz Nuclear Power Plant / 1975

QUALITY CERTIFICATIONS, NUCLEAR QUALIFICATIONS

ISO 9001, ISO 14001, ISO 45001, 166002:2014, ISO 50001:2011

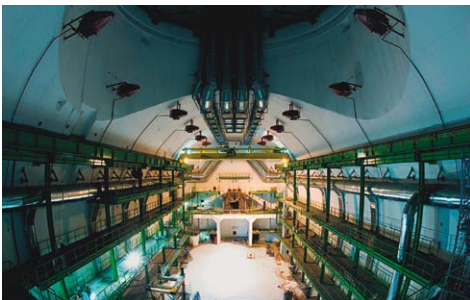

LHC - CERN



Trillo

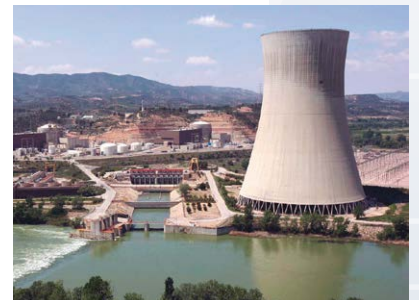

Ascó

COMPANY NAME	EGILE MECHANICS
ADDRESS	Pol. Ind. Kurutz Gain, 12-13, 20850 Mendaro (Guipúzcoa)
WEB	www.egile.es
TURNOVER	21,7 M€ in year 2021
EMPLOYEES	187 in year 2021
SME	YES
CONTACT PERSON	Philippe ROULET
	POSITION Commercial Director
	PHONE +34 647 64 29 60
	EMAIL philippe.roulet@egile.es

COMPANY ACTIVITIES AND SKILLS

Extreme precision machining of copper components and systems for accelerating structures and associated devices (discs, pets, yokes, extraction systems, RFQs, ...)

Collaborative projects for design, manufacturing, assembly and test of BUNCHERS, CYCLOTRONS, NANO-MOVERS.

Cryo-mechanisms and free form optics for space or ground optical instruments

Actuation, positioning, power and accessory transmission systems

LARGE SCIENTIFIC FACILITIES AND NATIONAL RESEARCH FACILITIES CONTRACTS

- [ESS Bilbao] RFQ manufacturing and assembly (2021)
- [CIEMAT] Accelerating structure for CLIC (2019)
- [ESA - AIRBUS DS] Reflectors for METOP mission (2018)
- [CIEMAT] Cyclotron for medical application (2016)
- [ESA - CEA] Cryomechanism for EUCLID mission (2016)
- [IFMIF - CIEMAT] Buncher IFMIF (2015)
- [European XFEL - CIEMAT] Movers XFEL (2014)

R&D PROJECTS

4ACCEL CDTI - Design, Manufacturing and Testing of a Technological Demonstrator of an Linear Collider Accelerating Structure based on the quadrant or half shape concepts (2010) (leader DMP, partners CERN-CIEMAT)

MARKETS

Defense / Aeronautics / Space / Proton therapy, Photolithography, Air-Bearing systems...

QUALITY CERTIFICATIONS, NUCLEAR QUALIFICATIONS

ISO 9001 / EN9100



Buncher. CIEMAT (IFMIF)



Reflectors for METOP Mission

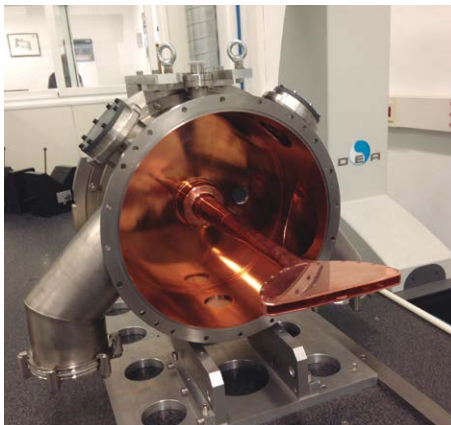

Cyclotron. CIEMAT

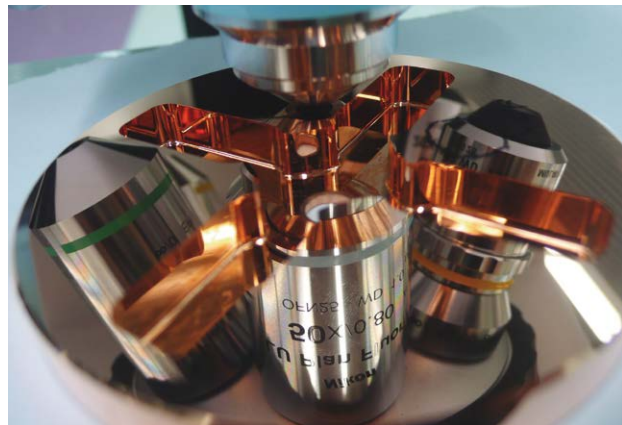

Disc (CERN)

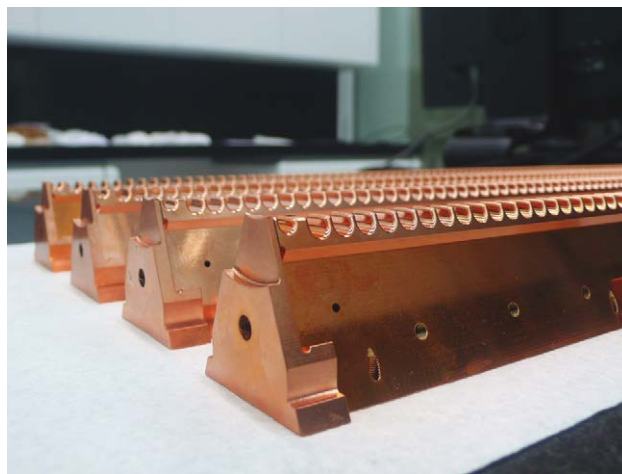

PET (CERN)

COMPANY NAME	EIIT a Controlar company
ADDRESS	Camino Robledo de Chavela, 9-B, Puertas 1-8, 28210 Valdemorillo - Madrid - Spain
WEB	www.eiit.com
TURNOVER	10,2 in year 2021
EMPLOYEES	118 in year 2021
SME	YES
CONTACT PERSON	Research and Development Department
POSITION	Research and Development Department
PHONE	+34 918 904 614
EMAIL	idi@eiit.com

COMPANY ACTIVITIES AND SKILLS

EIIT (Electronics, Informatics, Instrumentation and Telecommunications), is a Controlar company that gathers more than 35 years of experience, and it is leader in test engineering in the electronic, aeronautical, robotics and industrial automation fields.

EIIT aims to offer their customers the most innovative turnkey solutions and the most advanced technologies, capable of meeting the most demanding requirements thanks to their highly qualified team and a culture of continuous improvement that allows the company's adaptation to any situation, always complying with the highest standards of quality and value.

EIIT based its foundations on offering high levels of engineering, security and the vision required to start a business focused on the development of automatic test systems for electronics such as ICT (In Circuit Testing) and functional tests; This product line continues to be developed, increasing the technological capabilities and possibilities for different levels and customer requirements and standards. Nowadays EIIT expands its knowledge and expertise to these different areas; aeronautics, automation, special test equipment and solutions, equipment & partnerships, all of them focused on developing and managing cutting-edge projects to ensure that each product is manufactured in compliance with all quality and safety standards, while maintaining confidentiality and, of course, ensuring punctual delivery under the agreed conditions.

In 2016 EIIT started to work with Big Science installations in several projects for ITER, that are improving to this day.

LARGE SCIENTIFIC FACILITIES AND NATIONAL RESEARCH FACILITIES CONTRACTS

[ITER] INTERLOCK DISCHARGE LOOP INTERFACE BOXES (DLIB) CUBICLE (2019-22)
Design, supply and testing of 2 cubicles housing 30 Discharge Loop Interface Boxes (DLIB) and

Bypass Loop Interface Boxes (BLIB) (15 per cubicle). The contracted scope of work includes: design of the cubicles as per ITER PCDH guidelines and delivery of design documentation, design and execution of the test procedures, CE Marking of the two cubicles, packing and

transportation of the manufactured cubicles to IO headquarters, where they will be installed
 [ITER] INTERLOCK DISCHARGE LOOP INTERFACE BOXES (DLIB) FUNCTIONAL TESTER, (2017)

The test system will include up to 12 DLIB`s with the possibility of making loops from 2 DLIBS up to 12 DLIBS. The capabilities of the DLIB to be checked are: 1) Verification that oop current can be regulated between 7-17 mA with the terminator which has built-in resistors. 2) Verification that events in the range of 5-24V DC range can be read by DLIB. 3) Verification that the first event can be recorded when two or more interlock events happen in different DLIBs. 4) Verification that the PROFINET communication can work properly with DLIBs and with different topologies: 12 DLIB in linear, in star and linear star in mix.

[ITER] INDUSTRIALISATION AND PROCUREMENT OF THE ITER INTERLOCK DISCHARGE LOOP INTERFACE BOXES (DLIB) (2015-2017)

The interlock current loops are hardwired connections between the different equipment involved on the protection of the ITER superconducting coils and associated systems. This includes the quench detectors, fast discharge units, protective make switches and AC/DC converters.

The Discharge Loop Interface Box or DLIB is a common mechanical and electrical interface to all the 'users' of these hardwired loops. When an interlock event requiring a fast discharge of the superconducting coils occurs, the information is transmitted from the sensors to the actuators by the interruption of 3 redundant discharge loops. This electronic component has the main task of maintaining the continuity of the three wires of the loop, while interfacing the users of the loop.

Each DLIB reads the states of each sensor or controller, provided also via three wires, and propagate the state to the loop opening it or keeping its previous state. Depending on the case, it is configured to send the controller/actuator an 'open loop' state if the loop has been opened. This way the controller is able to react based on the state of the loop. Each DLIB is also connected to a PLC for monitoring and testing purposes.

MARKETS

Defense / Automotive Aeronautics / Space

QUALITY CERTIFICATIONS, NUCLEAR QUALIFICATIONS

ISO 9001 / CEFRI / ISO9100

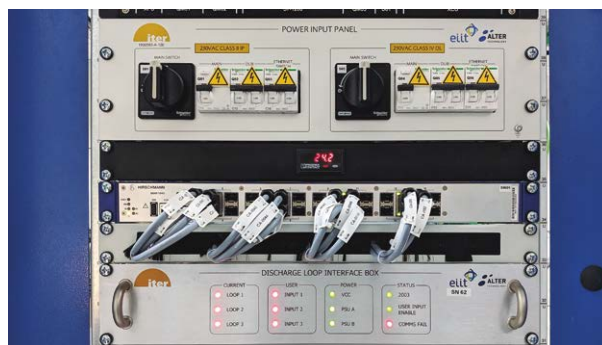

Power Input Panel and Discharge Loop Interface Box



COMPANY NAME	ELYTT ENERGY, S.L.
ADDRESS	Calle Orense 11, 2º B, 28020 Madrid
WEB	www.elytt.com
TURNOVER	8,5 Million € in year 2020
EMPLOYEES	55 in year 2022
SME	YES
CONTACT PERSON	Ángel García
	POSITION Sales Manager
	PHONE +34619039199
	EMAIL angel.garcia@elytt.com

COMPANY ACTIVITIES AND SKILLS

Elytt Energy it is an innovative Spanish company, working in high technology projects, solving the needs of our clients, in the field of the energy, fusion and particle accelerators, we currently have projects in Germany, USA, France, Italy and Switzerland

Designs and manufacture of fusion reactor structural systems, design and manufacturing of superconducting magnets for material characterization, design and manufacturing of TF and PF coils

Designs and manufacture resistive and superconducting electromagnets for particle accelerators of all types and designs and manufacture current regulated power supplies with high stability, low noise and reliability used in accelerators and research laboratories. The company provides a complete electromagnetic engineering, design, manufacture, and test service.

Designs standard and custom-built resistive magnets, reaching from small correctors, to very large magnets, 2D and 3D is used for magnetic field modeling.

Our workshop has all manufacturing facilities necessary, winding machines, vacuum system, oven, inert gas oven and all measurement equipment including magnetic measurement.

Elytt Energy offers complete magnet systems including vacuum chambers, supporting stands and matching power supplies

Dipole magnets, Quadrupole magnets, Multipole magnets, Spectrometer systems, Kickers, Septums and Bumper magnets, Scanning magnets.

Also, the following related services are available: FEM Mechanical – Electromagnetic calculation, Beam optical calculations, Vacuum calculation and design, Cryogenics calculation and design, On-site Installation.

LARGE SCIENTIFIC FACILITIES AND NATIONAL RESEARCH FACILITIES CONTRACTS

[GSI/FAIR] Supply of 21 Superferric dipoles. Magnets for the Super Fragment Separator

[CERN] Manufacture of 17 nested superconducting dipole MCBXFA and MCBXFB for the HL LHC

[PPPL] Manufacture of one TF bundle and OH solenoid for National Spherical Torus Experiment at Princeton Plasma Physics Laboratory

[ALS-U] Manufacture of 130 normal conducting quadrupoles and sextupoles for ALS-U project at Berkeley

[CERN] Design and Manufacture of the superconductor quadruple magnet (QUACO) for the HL LHC

[CBETA] Design and Manufacture of 132 magnets for the Energy Recovery Linear Accelerator CBETA Project CORNELL UNIVERSITY at USA

[SARAF] Design and Manufacture of 16 superconducting solenoid packages for CEA SARAF project & supply 8 superconducting solenoids

[ITER] Supply of 400 Outer Vessel Coils (OVCs)

[ITER] Supply of the handling and impregnation tooling required for the production of the PF coil magnets, a contract worth of 30 Million

[CERN, BRAC, ESS – JNFN Legnaro] Design and manufacturing of permanent magnet quadrupoles for the drift tube of the Linac for CERN, BRAC and to INFN Legnaro for ESS Lund

[CERN] Supply a Vacuum Impregnation

[ITER] Manufacturing of 10 Toroidal Field Coils. 110 Tones each.

[CERN] Supply of storage ring quadrupole magnets for the SESAME project

[CERN] Supply of Beam Transfer line Quadrupole Magnets for the HIE-SOLDE Facility

MARKETS

Energy / Accelerators and research laboratories

QUALITY CERTIFICATIONS, NUCLEAR QUALIFICATIONS

ASME / ISO 9001



Quadrupole Magnets



Toroidal Field Coils for ITER F4E



EMPRESARIOS AGRUPADOS

COMPANY NAME	EMPRESARIOS AGRUPADOS INTERNACIONAL, S.A.
ADDRESS	Calle Magallanes, 3 28015 Madrid (Spain)
WEB	www.empresariosagrupados.es
TURNOVER	69.336,15k€ (year 2020)
EMPLOYEES	1300 (trainees included) (year 2022)
SME	NO
CONTACT PERSON	María Teresa Domínguez Bautista
	POSITION Advanced Projects and R&D Director
	PHONE +34 913098022
	EMAIL mtdominguez@empre.es

COMPANY ACTIVITIES AND SKILLS

Empresarios Agrupados Internacional, S.A. is an engineering consultant/architect-engineering company founded in 1971. EA is a leading organisation with significant experience worldwide. It provides complete solutions in the fields of consultancy, project management, engineering and design, procurement, manufacturing, installation, construction management, testing planning, nuclear safety support, quality assurance, as well as support to operation in the following areas and industrial sectors:

EA works in the following areas: nuclear fission power plants (new built and support to NPPs in operation), SMRs fission power plants engineering (all technologies), large infrastructures and scientific research installations (ITER, CERN, ESS), innovative nuclear systems and research reactors for fission and fusion technologies, conventional power generation (coil and gas), aerospace, defence and civil aviation, IT, decommissioning and radioactive waste management, including design of low and intermediate level waste treatment and spent fuel storage facilities.

LARGE SCIENTIFIC FACILITIES AND NATIONAL RESEARCH FACILITIES CONTRACTS

[F4E-ENGAGE] Architect Engineering Services for ITER Building – Construction Design (2022)

[ITER Organization (IO)] Tokamak Cooling Water System (TCWS) – Engineering Work Packages (2021)

[ITER Organization (IO)] Central Safety System Nuclear (SCS-N) – TCWS cubicles (2021)

[ThorCon International] Architect Engineering Services for the molten salt reactor TMSR-500 (2021)

[CIEMAT] ITER Diagnostics – TS (2021)

[F4E] ITER First Wall Panel Series Manufacturing (2020)

[ITER Organization (IO)] ITER Installation contract of safety pipes - TCC2 (2020)

[SCK.CEN/MYRRHA] Implementation of the innovative MYRRHA research reactor (2019)

[EUROFUSION-DONES] 2019 Dones-PreP (ESFRI) Support for the preparatory phase for

the DEMO Orientated Early Neutron Source IFMIF/
DONES (2019)

[ABEN] MODELING AND SIMULATION STUDY FOR RADIOPHARMACEUTICAL DISTRIBUTION LOGISTICS (2019-delivered)

[ITER Organization (IO)] Final design of the Connection Pipes for the Test Blanket System Contract (TBS-CP) (2016)

[CIEMAT/ EUROFUSION] DONES (DEMO-Oriented Neutron Source) (2016)

[CIEMAT/ EUROFUSION] Test Blanket Modules (TBM) Systems – TCWS system (2015-2021)

R&D PROJECTS

EA has carried out several nuclear projects for international institutions and research and development programmes of the European Union, the World Bank and the European Bank for Reconstruction and Development. In fission technology, EA has participated in more than 20 EURATOM projects.

In fusion technology, EA has more than 20 years of experience in the field of nuclear fusion technology development, starting with the ITER Engineering and Design Phase (EDA) through contracts with EFDA (EU) (1994-2004), followed by the ITER Realization Phase since 2004, through contracts with IO, F4E and CIEMAT. In support of fusion technology, EA has carried out contracts with Eurofusion and with EU for development of DONES and DEMO.

[CDTI - MISIONES] MIG-20201051 – Fusion for Future (MISIONES) (2021)

[CDTI - MISIONES] MIG-20211066 – Industrial research in technologies and processes applied to IFMIF-DONES in order to evolve in the fusion programme (DONES-EVO) (2021)

In SMR technologies, EA has more than 20 years' experience in all technologies (molten salt, gas cooled and liquid metals cooled).

MARKETS

Nuclear / Defense / Space / Energy / Oil & gas

QUALITY CERTIFICATIONS, NUCLEAR QUALIFICATIONS

ISO 9001 / ISO 14001



ITER first wall panels

ITER Tokamak Complex Contract

COMPANY NAME	EMBEDDED INSTRUMENTS AND SYSTEMS S.L.
ADDRESS	Parque Científico UMH, Avda. de la Universidad sn, 03202 Elche, Alicante, Spain
WEB	www.emxys.com
TURNOVER	389.135,40 in year 2021
EMPLOYEES	10 in year 2021
SME	YES
CONTACT PERSON	José A. Carrasco
	POSITION CEO
	PHONE 34 966 442 304
	EMAIL joseacarrasco@emxys.com

COMPANY ACTIVITIES AND SKILLS

Electronic design of sensors and actuators, including high speed electronics, for operation in harsh environments: extended temperature range, radiation and vacuum. FMECA, Part Stress, Worst Case and Reliability analysis.

LARGE SCIENTIFIC FACILITIES AND NATIONAL RESEARCH FACILITIES CONTRACTS

[ESA] Reduction of Electromagnetic Interferences from Power Converters and Filters

Very low EMC noise 36W power converter for Point of Load Scientific Applications (2021-2022)

[ESA] Low Cost Low Resolution Position Sensor (LRPS) (2019-2021)

Angular sensor with no contact parts between the moving elements for low resolutions of up to 10-12 bits to be used in harsh environments (vacuum, radiation and extreme temperatures) and low cost

[ESA] Electrically Coupled Angular Encoder for Long-Life Mechanisms (2019)

Angular sensor with no contact parts between the moving elements for medium resolutions of up to 16 bits to be used in harsh environments (vacuum, radiation and extreme temperatures).

[CSIC], Design and validation of the electronics module for ultraviolet spectrometers (2017-2019).

Electronic system to drive an ultraviolet spectrometer to be deployed into low Earth orbit to look for anthropogenic gases that contribute to greenhouse effect.

[ESA] Asteroid Impact Mission (AIM) Cubesat Opportunity Payloads (2015 – 2016)

Project to study the possibility of a Cubesats mission accompanying the maiden spacecraft to the asteroid Dydimos after the impact of the NASA DART impactor. EMXYS participated as subcontractor of the Royal Belgian Observatory to propose a lander to study the gravity and surface properties of the asteroid.

R&D PROJECTS

- On board computer for the control of a fibre optics transceptor (2019)
- Computer to control an optical transceiver for free space communications.
- Space free optical transceptor for satellite communications (2020-2022)
- Optical transceptor for free space communications of up to 100Mbps.
- Small platform for space scientific applications (2021-2022)
- Satellite platform for space constellations.

MARKETS

Nuclear / Defense / Aeronautics / Space

QUALITY CERTIFICATIONS, NUCLEAR QUALIFICATIONS

ISO 9001 / AES 9100



Detail of rack unit for testing charge Coupled Devices for ultraviolet cameras



Working in EMXYS ISO 7 clean room

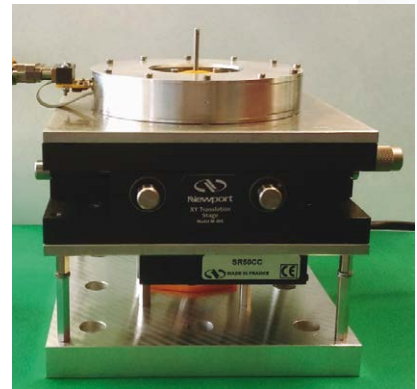

LRPS Low Resolution Angular Sensor (10-bits) for harsh environments (radiation and extreme temperatures)



RACK Electrical Ground Support Equipment for testing scientific equipment IR and UV cameras

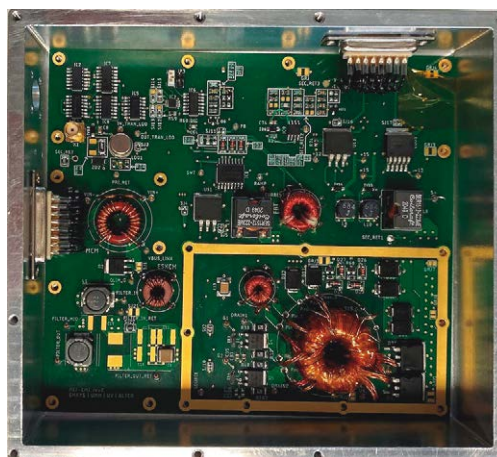

RE_PS Very Low Electromagnetic Noise Power Supply for Scientific Applications

Testing a FPGA based PCB to test camera CMOS sensors under a vacuum environment

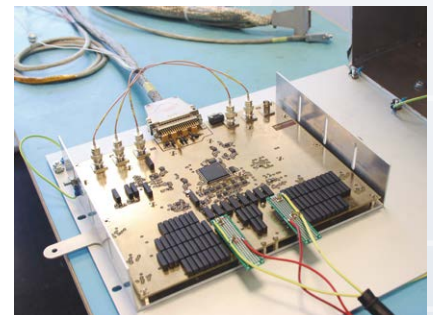



COMPANY NAME	Equipos Nucleares S.A.,S.M.E. (ENSA)
ADDRESS	Avda. Juan Carlos I, nº8
WEB	www.ensa.es
TURNOVER	58 M€ in year 2021
EMPLOYEES	503 in year 2021
SME	NO
CONTACT PERSON	Rubén Moreno Zubelzu
	POSITION Marketing and Sales - Business Development
	PHONE 942 200 101
	EMAIL moreno.ruben@ensa.es

COMPANY ACTIVITIES AND SKILLS

Ensa, Equipos Nucleares S.A., was created in 1973 to design, build and operate an industrial plant to undertake the manufacturing of primary components of Nuclear Steam Supply Systems of any type of reactors.

Over the years Ensa has delivered different heavy components (reactor pressure vessels, steam generators, pressurizers, core structures) in collaboration with the main international reactor vendors for nuclear power plants all over the world.

Ensa is also supplying owned and other designs of spent fuel storage and transportation systems as racks and casks. A Services Division was launched in 1980 to offer special capacities in the areas of maintenance, site repairs, modifications, retrofits, installation works, waste treatment, conditioning area and high experience in the market of decommissioning and dismantling nuclear and radioactive facilities.

Nuclear Components: Reactor pressure vessels, steam generators, pressurizers, core structures, main coolant piping, supports, tanks of different types, fuel element hardware, etc.

Elements for spent fuel storage and/or transport: Owned tailor-made design and license solutions for high density racks for wet storage, spent fuel transport and storage casks, spent fuel storage canister and overpacks, handling casks systems at site.

Other products: Components for research centers and development programs.

Technology Services: Analytical engineering, special projects, robotic applications, laboratory services.

SERVICES AREA

Plant Maintenance: Nuclear and conventional plant maintenance.

Radwaste Treatment-Conditioning and Decommissioning of nuclear and radioactive installations: Supply of equipment and services, cu cutting and disassembly of equipments, decontamination, treatment and conditioning of waste.

LARGE SCIENTIFIC FACILITIES AND NATIONAL RESEARCH FACILITIES CONTRACTS

[ESS] Manufacturing and installation of Monolith Portblocks for ESS (2021)

[ASTRID] Steam Generator Manufacturability + Tubing Mock Up for ASTRID Project (2019)

[JHR]: In Consortium with Empresarios Agrupados, delivery and instalation of 3 Hx for the Jules Horowitz Experimental Reactor (CEA + CIEMAT) in Cadarache (France) (2019)

[ITER] Contract of the 2º part of anks for the Water Detriation System for F4E.lter (2016). It includes the supply of 2 Holding Tanks (7m3) and 2 Feeding Tanks (12m3) for tritiated water.

[ITER] Contract of Final design & Manufacturing of Triated Water Holding Tanks and Emergency Tanks of Water Detriation System (2013). It was manufactured and supplied of 4 holding tanks (20 m3) and 2 emergency tanks (100 m3) for tritiated water and it was succesfully delivered on 2015 in Cadarache.

[ITER] Contract for the Impact of narrow distance between welds and weld overlapping (2013)

[ITER] Start with the first project stage: Development Phase where Ensa team study all the techniques that will be used during the production phase in Cadarache (2013)

[ITER] Contract for the Vacuum Vessel and Port the Assembly (2012). The scope of this contract awarded in 2012 by ITER Organization is the assembly at site of the Vacuum Vessel Sectors and its ports. This work required the development of many qualifications, processes (welding, control, testing, etc.) and associated devicesand tools.

[ITER] Advance Distortion Simulation Techniques during the manufacturing of structures for large plants (2008)

[ITER] Feasibility Study for the Vacuum Vessel ITER project (EU-TBM) (2007)

[ITER] Feasibility Study for the development and manufacturing of European test modules for lter project (EU-TBM). (2007)

MARKETS

Nuclear / Energy

QUALITY CERTIFICATIONS, NUCLEAR QUALIFICATIONS

ASME / RCC-MR / ISO 9001 / ISO 14001 / CEFRI / ISO 3834 / ISO 17025 / OHSAS 18001 / UNE 166002 / ISO/IES 27001 / HAF 604 / KHNP



ITER vacuum vessel welding mockup

COMPANY NAME	EOSOL
ADDRESS	Calle Camino de Labiano 45ª, 31192, Mutilva, España
WEB	www.grupoeosol.com
TURNOVER	30M€ in year 2021
EMPLOYEES	525 in year 2021
SME	NO
CONTACT PERSON	Gonzalo Crespo López
	POSITION Aerospace Director
	PHONE +34 664 68 39 51
	EMAIL gonzalo.crespo@eosolgroup.com

COMPANY ACTIVITIES AND SKILLS

EOSOL is a privately owned engineering services group with international presence. Founded in 2008, the company has offices in 12 countries and develops projects in more than 40 countries. EOSOL offers engineering services, solutions and products in strategic sectors such as energy, oil&gas, chemical, telecommunications, defense or space.

EOSOL is divided in 5 different divisions:

- Aerospace: The division provides radiofrequency and antennas engineering (design, manufacture, assembly and test) for the scientific, aeronautical, defense and space sectors.
- Engineering: A comprehensive service covering all phases of a project. The division provides different technical services in different phases of energy, civil works and infrastructures projects.
- O&M: Specialized in renewable energy sector. We provide operation and maintenance services to ensure plants are in the best possible conditions to maximize energy production.
- Services: Technical assistance in the areas of design, quality, manufacturing engineering, industrialization and logistics.
- Tech: Expertise in software development, Cloud and On-Premise IT systems, data analytics, programming and industrial automation. The division also provides high-reliable monitoring solutions based on EMPRO® (a powerful and scalable monitoring system tool to control machines, plants and processes) and OSIRIS® (Artificial intelligence platform focused on advanced data and image analytics, behavioral modelling and predictive maintenance.).

According to Big Science capabilities, the following applies:

EOSOL Aerospace team has proven technical, quality and management capacity to accomplish complex and challenging projects related to antennas, feeds and radiofrequency components (OMT, polarizers, filters or diplexers) operating in different frequency bands from VHF up to THz frequencies. During these years our team has been in charge of different national and European projects leading different consortiums as prime contractor as well as

participating as subcontractor. In terms of technical skills, our engineering team accomplish the complete life cycle of the project from feasibility study up to delivery of qualified products. We accomplish the following tasks during the process: 1) RF and mechanical design and analysis, 2) Manufacturing and test plan generation, 3) Manufacturing and assembly of parts, 4) Test and qualification of components or sub-systems

EOSOL Tech has deep knowledge in software development, infrastructure and Cloud and On-Premise IT systems, data analytics, programming and industrial automation, as well as telecommunications and networks.

LARGE SCIENTIFIC FACILITIES AND NATIONAL RESEARCH FACILITIES CONTRACTS

[ESA] – 4000132342/20/NL/AS: A Low-Frequency and Wide-Band Reflector Antenna Feed for Future Earth Observation Radiometers

[ESA] – 4000133733/21/NL/CT: Sub Millimeter Wave VALidation Standard ((sub)mm-VAST) Antenna

[ESA – COMET Ingeniería] - 4000130171/20/NL/AS: Deployable Reflector Antenna for Cubesat Missions

R&D PROJECTS

[Gov. Navarra] - Development of a monitoring and control system for photovoltaic power plants and industrial assets. (2019)

[Gov. Navarra] - Design and validation of a feeding system for satellite antennas based on two dual-band radiating chains. (2020)

[Gov. Navarra] - Design of feed chains for future large radio telescopes. (2022)

MARKETS

Nuclear / Defense / Naval / Aeronautics / Space / Energy / Oil & gas / Water

QUALITY CERTIFICATIONS, NUCLEAR QUALIFICATIONS

RCC-MR / ISO 9001/ ISO45001 / UNE-EN9100



K-Ka band feed for radiometers



sub-mmW VAST Antenna



UWB Feed Array cluster for future radiometers

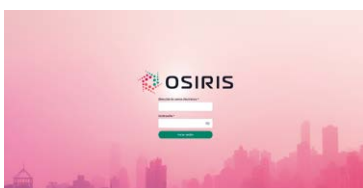

OSIRIS AI software tool

**COMPANY NAME**

ESTEYCO S.A.

ADDRESS

Avenida de Burgos, 12B-Bajo I 28036 Madrid

WEB

www.esteyco.com

TURNOVER

22.7 M€ in year 2021

EMPLOYEES

198 in year 2021

SME

YES

CONTACT PERSON**Fernando Rueda Guglieri****POSITION** Head of ESTEYCO Mechanics**PHONE** +34 661.10.20.43**EMAIL** fernando.rueda@esteyco.com

COMPANY ACTIVITIES AND SKILLS

Esteyco is an independent engineering and consulting firm with 200 employees and more than 50 years of experience all over the world.

Activities in Big Science cover the design, analysis, manufacturing, assembly, testing and commissioning of complex structures and mechanical systems. This is implemented through either an integrated approach, spanning the whole development cycle, or specialized consultancy services at different stages of the project.

Esteyco's focus is on non-conventional developments with stringent thermal and/or mechanical constraints that require going beyond what is common practice in structural and mechanical engineering. In-depth knowledge of engineering principles and state-of-the-art capabilities are applied by Esteyco to ensure compliance with requirements. Main Esteyco assets include:

- i) Large experience in the design and manufacturing of complex and one-of-a-kind mechanical systems
- ii) Advanced analysis capabilities and sound engineering judgement in an extremely wide range of disciplines
- iii) Familiarity with main design and construction codes
- iv) Combined and strongly coupled civil-mechanical engineering approach, essential for those developments involving large components and complex interfaces
- v) Expertise in instrumentation and state-of-the-art developments in the engineering-oriented interpretation of experimental data
- vi) Mechatronics

LARGE SCIENTIFIC FACILITIES AND NATIONAL RESEARCH FACILITIES CONTRACTS

[ITER Organization] IO/20/CT/6000000312, "Development of ITER Tokamak Systems Monitoring" (2020-Ongoing).

[Fusion for Energy] F4E OMF-1023-01 "Engineering support in the area of seismic, dynamic and structural analyses of ITER buildings and mechanical components" (2020-Ongoing).

[Fusion for Energy] F4E-0950-01, "Preliminary and pre-final design of the HCPB TBM set including a part of the preliminary design for the WCLL TBM set – Analyses and design validation" (2019-Ongoing).

[UKAEA] UKAEA T/VT087/19, "STEP WP5 - Fusion Power Plant - Breeder Blanket Design Challenge" (2019-2020):

[ITER Organization] IO/17/CT/4300001624, "Design Finalization and Development of Reconstruction Algorithms for the Operational Instrumentation of the Internal Components (Blanket Modules & Divertor)" (2018-Ongoing):

[ITER Organization] IO/CT/16/4300001322, "Cryostat Analysis and Structural Integrity Assessment" (2016-2020):

[ITER Organization] IO/CT/16/4300001330, "Vacuum Vessel Pressure Suppression System (VVPSS) Analysis and Structural Integrity Assessment" (2016-2018):

[Fusion for Energy] F4E-0503, "Framework service contract for the provision of engineering support in the area of seismic, dynamic and structural analyses of ITER buildings and mechanical components – Lots 1 (Seismic analysis and design) & 3 (Structural analysis and design)" (2015-2019)

R&D PROJECTS

[CDTI-CIEMAT] – "Investigación industrial en tecnologías expuestas a neutrones (Neutron EXposed Technologies) de aplicación a la Test Cell de IFMIF-DONES (DONES-NEXT)" (2021 – en curso)

[CDTI-CENER] – Proyecto MIP-20201009 "Liderazgo español para el avance de la eólica flotante (LEAF)". (2020 – en curso)

[CDTI - ICV CSIC – IES UPM] Proyecto MIP-20201003 "Almacenamiento termo-eléctrico por reflectaria aumentada (ALTERA)". (2021 – en curso)

[CDTI-IAC] Proyecto INNO-2018 1012 "Advanced technologies for solar telescopes" (2018-2019)

[CDTI-CIEMAT] Proyecto CIEN IDI-20160851 "Accelerators and technologies associated to Big Science projects (ACTECA) – Design of systems and components for metal liquid loops" (2017-2020)

MARKETS

Nuclear / Defense / Automotive / Naval / Aeronautics / Space / Energy

QUALITY CERTIFICATIONS, NUCLEAR QUALIFICATIONS

RCC-MR / ISO 9001 / ISO 14001

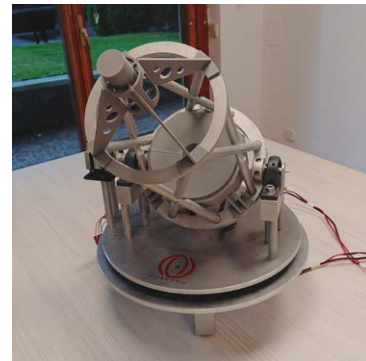

Scaled prototype for testing of control and actuation strategies for the EST main structure

COMPANY NAME

FAGOR AUTOMATION

ADDRESS

Barrio San Andrés 19, 20500 Mondragón

WEB
www.fagorautomation.com
TURNOVER

70 M€ in year 2021

EMPLOYEES

600 in year 2021

SME

NO

CONTACT PERSON
José Óscar Fernández Lorences
POSITION Marketing Manager (Encoders Business)

PHONE +34 619 210 018

EMAIL ofernandez@fagorautomation.es

COMPANY ACTIVITIES AND SKILLS

Fagor Automation designs and manufactures CNC systems, drives, motors and encoders for automatization and control of diverse equipments. The encoder catalogue range comprises high accuracy open or enclosed linear and angular models with analog or absolute digital interfaces.

Along 40 years of history the company has deployed a strategy based in two main pillars; i) Development of know-how increasing the added value for customers; ii) International growth. As a result the company develops its own software, hardware, electronics, optics and mechanics for the diverse products what has yielded 30+ patents. Besides, the worldwide commercial network comprises owned subsidiaries in 16 countries and is present in many other countries through distributors.

Fagor Automation is a recognised provider of solutions in the market that excels in the quality of the products, unbeatable delivery times, flexibility and outstanding support and service to customers throughout the complete process.

Fagor Automation specific products have been integrated in Large Scientific Infrastructures by direct issued Purchase Orders or through integrators. Undulators are the most common equipment using linear absolute encoders for controlling the gap between the magnets. Specific projects of undulators using Fagor encoders were published in several scientific articles presented at dedicated Particle Accelerator Conferences. Other equipped applications comprise anti-collision systems or index tables.

A comprehensive network of customers, contractors or subcontractors of main projects for Large Scientific Infrastructures that integrate Fagor products in their equipments constructed for those installations is also maintained.

LARGE SCIENTIFIC FACILITIES AND NATIONAL RESEARCH FACILITIES CONTRACTS

Among others the products have been directly sold to:

[SLAC National Laboratory operated by Stanford University for the U.S. Department of Energy Office of Science] Linear high accuracy absolute encoders (2013, 2016-2021)

[Advanced Photon Source (APS) at the U.S. Department of Energy's Argonne National

Laboratory] Linear high accuracy absolute encoders (2014, 2016)

Australian Synchrotron belonging to the Australian Nuclear Science and Technology Organisation (ANSTO)] Linear high accuracy absolute encoders (2015)

R&D PROJECTS

Fagor Automation has its own R&D Department and Technological Center consisting of nearly 85 engineers, scientists and technicians, including a remarkable number of PhD graduates in engineering or science disciplines.

Fagor Automation participates in projects funded by national institutions. It is also proactive in becoming partner in European funded projects. The Scientific Infrastructures may benefit of the developments and advantages rendered by those projects. From a new enhanced optoelectronic technology named as 3STATECH to specific mechanical designs accounting for temperature or other magnitudes variations. It is the main objective to supply highly accurate, repeatable and robust products for fine positioning and smooth control solutions.

MARKETS

Machine-Tool / Metrology and Positioning equipment / Particle Science equipment and instrumentation

QUALITY CERTIFICATIONS, NUCLEAR QUALIFICATIONS

ISO 9001



Linear encoders, angular encoders and CNC systems for equipment automatization

COMPANY NAME	FERROVIAL,S.A.
ADDRESS	Príncipe de Vergara 135. 28002 Madrid. España.
WEB	www.ferrovial.com
TURNOVER	6.778 in year 2021
EMPLOYEES	63.070 in year 2021
SME	NO
CONTACT PERSON	Gabriela Álvarez Castro
	POSITION Business Development & Strategy
	PHONE +34 91 300 85 00
	EMAIL mgalvarez@ferrovial.com

COMPANY ACTIVITIES AND SKILLS

Since its foundation in 1952, Ferrovial started to pursue our goal of being what we are today, a leading company with the vision to develop and operate innovative, efficient and sustainable infrastructure while creating value for our stakeholder.

The company has more than 92.113 employees and a presence in over 15 countries. It is a member of Spain's blue-chip IBEX 35 index and is also included in prestigious sustainability indices such as the Dow Jones Sustainability Index and FTSE4Good.

The company's activity is carried out through four business lines: Construction, Industry, Services, Toll Roads and Airports.

Ferrovial Construction is the business unit responsible for performing civil engineering, construction, water treatment plants and industrial works. It is recognized internationally for its capacity to design and execute unique and sustainable construction works, in particular major transport infrastructures, with an amount of turnover 6.077 M€ in year 2021 representing 90% of the whole Ferrovial.

Ferrovial Construction is currently working on the ITER project contributing with its expertise in construction of large industrial facilities, as well as a deep knowledge of a wide range of civil works and M&E activities. The company has also been involved in all major nuclear projects in Spain.

Its extensive experience is endorsed by having implemented more than 547 km of tunnels, 15.791 km of New Roads, 4.678 km of P3 Highways and 5.801 km of New Railway Track (including 1.043 km of High-Speed Rail).

It also stands out for its commitment to safety and environment: Construction has reduced its frequency rates in 2021 by -12% compared to 2020 and by -57% in the last ten years thanks to the active commitment of all its employees, the identification and preventive observation of high potential situations, and the continuous training of employees with critical roles.

LARGE SCIENTIFIC FACILITIES AND NATIONAL RESEARCH FACILITIES CONTRACTS

Contracts Awarded to Ferrovial Construction,S.A in the ITER Complex Caradache.

[F4E] - (TB06) HV Electrical Equipment (2014)

Design, supply, installation, commissioning, testing and maintenance of electrical equipment (PBS43 and PBS41.PP) and design, construction, commissioning, testing and maintenance of buildings and associated infrastructure (F4E-OPE-428).

[F4E] - (TB05) Design & Build Buildings 32,33 and 38 (2013)

Includes the buildings 32 and 33 of 4.875 m² each, where will be done the conversion of power supply for the energization of the magnets, and the building 38 which has an area of 778 m² and will be where reactive power will be controlled. The main feature of these buildings is the existence of electromagnetic fields generated by the equipment included and this requires avoiding the use of ferrous materials in the range of the fields, and forcing to use concrete reinforced with fibers for some of the pillars, building walls and slabs of concrete of pits. The foundation will be underground to avoid being affected by electromagnetic fields.

[F4E] - (TB07) Design & Build Buildings 64,67,68 and 69 (2013)

Includes the Building 67 of 7.740 m² which corresponds with storage tanks of hot and cold water for cooling towers, the building 68 of 416 m² for water pumping station, the building 69 of 1.500 m² for heat exchangers and the building 64 of 540 m² for water treatment.

In this contract, the building 67 is the work most important because its scope includes design, civil works and the installations, highlighting the foundations, structure and waterproofing of "hot & Cold basin"

[F4E] - (TB03) Civil Engineering & Finishing Works (2012)

Includes a total of 11 buildings, storage areas, and bridges between buildings, highlighting among them the Tokamak complex (building 11-Tokamak, 14-Tritium and 74-Diagnostic) where will be located the reactor and 13-assembly building where will take place the previous assembly of elements.

Ferrovial was a semi-finalist in the tender of:

F4E - (TB04) Hvac, Electrical, I&C , Handling equipment, Liquid Networks.- 2013

MARKETS

Nuclear / Defense / Automotive / Naval / Aeronautics / Energy / Oil&gas

QUALITY CERTIFICATIONS, NUCLEAR QUALIFICATIONS

ISO 9100, ISO 14001, ISO 50001, Certificate of Quality System for Building and civil works services at the sites of the Spanish nuclear power plants. (UNE 73401:1995)



Aerial View_October 19_© ITER Organization-EJF Riche



Tokamak Assembly pit_March 19_© ITER Organization-EJF Riche

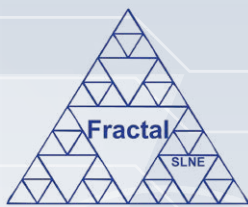

COMPANY NAME	FRACTAL S.L.N.E.
ADDRESS	C/ Tulipán 2, portal 13, 1A. E-28231 Las Rozas de Madrid (Madrid)
WEB	www.fractal-es.com , www.fractalslne.es , www.fractalastrojobs.com
TURNOVER	1.011.539,86 €, in year 2018
EMPLOYEES	FRACTAL works with a team of 12 senior consultants
SME	YES
CONTACT PERSON	María Luisa García Vargas
	POSITION General Manager
	PHONE +34 916379640 / +34 630737981
	EMAIL marisa.garcia@fractal-es.com

COMPANY ACTIVITIES AND SKILLS

FRACTAL SLNE is a private company belonging to the technological activities sector, founded in August 2005, being now almost 15 years old. We provide consultancy in Management, System Engineering, RAMS analyses, Optics and opto-mechanics, Mechanics, Software and Control systems, mostly for scientific projects.

FRACTAL customers are Research and operation centres and universities, and also engineering private companies, working all of them in Research & Development Projects for scientific applications.

Our main area of expertise is the development of professional astronomical telescope, instrumentation and software. Most of FRACTAL's consultants worked at GRANTECAN Company, in charge of the development of the 10-m telescope, the GTC, in the areas of Management, System Engineering, Instrumentation and Software.

Starting from the basic scientific requirements, FRACTAL can produce feasibility studies, designs (at different levels) or even the development of the whole scientific project. In particular, FRACTAL can do the specification, design, acquisition and tests of collimators, cameras, filters, prisms, and Volume holographic gratings (VPHs), especially for Astronomy applications and measuring systems. FRACTAL has also developed proprietary software tools for Management and System Engineering and has a human resources business line, <https://www.fractalastrojobs.com/>.

FRACTAL has two know-how license agreement with ESO: for Continuous flow cryostat technology (2015) and for Anti-Vibration mounts for Cold heads (2018).

FRACTAL's projects and references: <https://www.fractalslne.es/files/IntroducingFractal.pdf>. A presentation of the company is on-line: <https://www.fractalslne.es/files/FRACTAL-Services-Instrumentation-and-software-general.pdf>

LARGE SCIENTIFIC FACILITIES AND NATIONAL RESEARCH FACILITIES CONTRACTS

[GEMINI TELESCOPE – SOUTHWEST RESEARCH INSTITUTE] Optics, Mechanics and Cryogenics, of SCORPIO instrument (2017 – 2022). Contract with South West Research Institute (San Antonio, USA)

[TELESCOPIO SAN PEDRO MARTIR - Management and System Engineering for the 6.5m telescope in Baja California, project participated by two Mexican Research institutions (IA-UNAM in Mexico DF and INAOE in Puebla) and two in the United States of America (Smithsonian Astrophysical Observatory and the University of Arizona's Department of Astronomy / Steward Observatory).

[GRANTECAN – Universidad Complutense de Madrid] – MEGARA instrument for the 3.5m telescope (2017). Management and System Engineering, as well of other technical work packages

[CALAR ALTO OBSERVATORY] – CARMENES instrument for the 3.5m telescope at Calar Alto (2015). Management and System Engineering, as well of other technical work packages

MARKETS

Astronomy and Astrophysics / Management / System Engineering and Software

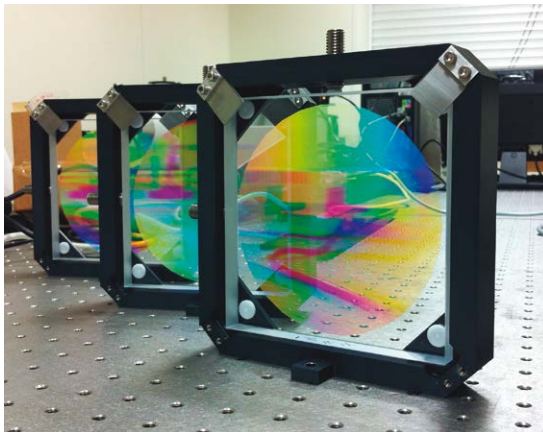

Volume Phase Holographic gratings for ARES spectrograph at Joan Or ϕ telescope(customer IEEC, Barcelona)

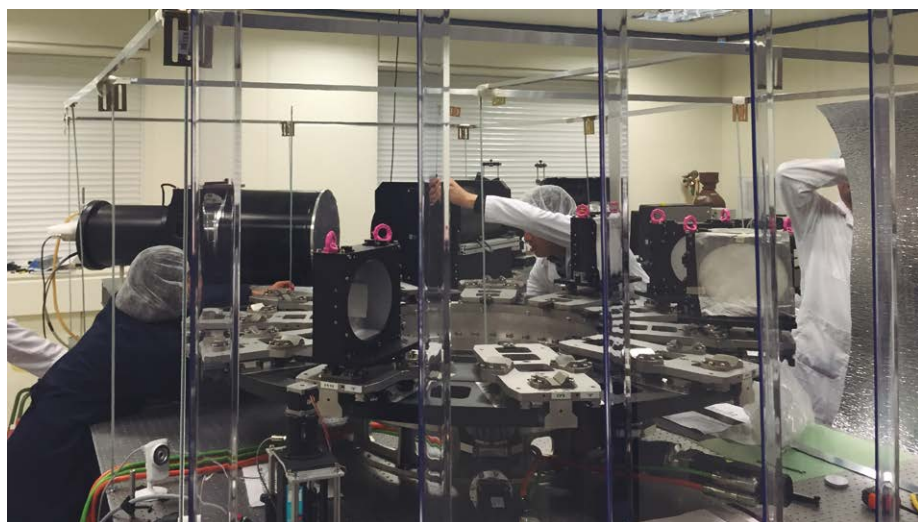

MEGARA spectrograph for the GTC 10m telescope during the assembly at laboratory in Universidad Complutense (customer UCM, Madrid)

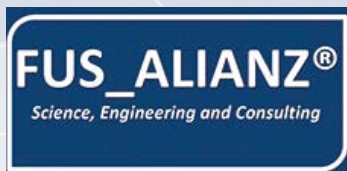

COMPANY NAME	FUS_ALIANZ® SCIENCE, ENGINEERING AND CONSULTING
ADDRESS	Nord 19, ático, El Vendrell (Tarragona)
WEB	www.fus-alianz.eu
TURNOVER	aprox. 230 k€ in year 2021
EMPLOYEES	4 In Year 2021 (1 + 3 Trade + More Than 8 Ext. Colabs.)
SME	YES
CONTACT PERSON	Dr. Luis A. Sedano
	POSITION Innovation Dept., Director
	PHONE + 34 657208460
	EMAIL ls@fus-alianz.eu

COMPANY ACTIVITIES AND SKILLS

FUS_ALIANZ® is a young Spanish Technology-based small company. F_A® starts activity by 2015 as a highly qualified R&D and specialized provider of Technology Services. Our costumer are typically large and small Companies, R&D Technology Centers and Universities. Such initial service profiling is overlaps the F_A® own engineering and R&D activities. Specifically, F_A® engineering and R&D is targeting at present a wide set of products and developments in different sectors of Industry of Science business. FUS_ALIANZ® is, at present, pushing developments towards: (A) the industrial scaled provisions of base-of-design materials with Nuclear Quality Assurance: as (1) special structural alloys produced by new manufacturing powder metallurgy routes; and (2) industrial production of fusion functional materials as lead-lithium eutectics and lithium-ceramics; (B) Supercomputing platforms for advanced nuclear design and predictive nuclear systems modeling software; (C) New nuclear active diagnostics sensor concepts with special intensification in tritium in nuclear effluents.

LARGE SCIENTIFIC FACILITIES AND NATIONAL RESEARCH FACILITIES CONTRACTS

The background of FUS_ALIANZ® professionals' in the Industry of Science market has been built for decades through collaborations among a large set of EU National Institutions and companies worldwide. Specific focuses of the Company activities within the Industry of Science area are devoted to European Spallation Source (ESS-Bilbao) and Nuclear Fusion activities (ITER and beyond).

R&D PROJECTS

[CDTI - INPROCESS CONSULTING AND TECHNOLOGY GROUP] ITTSIM2016® Project. Development of dynamic tritium predictive simulation tools in HYSIS /Aspen+ (2016) as support to a PI+D awarded by CDTI. Sector: NUCLEAR FUSION.

[CDTI – PROCON SYSTEMS] PROCODAC® Project (COntrol Data Access and COmmunication prototyping for tritium mass-balance dynamic control demonstration in ITER (2014) as support to a PI+D awarded by CDTI. Sector: NUCLEAR FUSION.

[CDTI - INPROCESS CONSULTING AND TECHNOLOGY GROUP] Development of

steady-state tritium predictive simulation tools in HYSIS /Aspen+ commercial software (2013) as support to a PI+D awarded by CDTI. Sector: NUCLEAR FUSION.

[GÉNIE ET CONSEILS] Towards Integrated computational platform development for nuclear components design analysis. (2012) Sector: NUCLEAR FUSION.

FUS_ALIANZ® OWN R&D PROJECTS (NUCLEAR FUSION SECTOR)

- EUTECTICS®: Industrial production of LLE under nuclear QA standard
- TSENSORS®: Active sensing of tritium concentration in nuclear effluents.
- New injector developments for powder metallurgy.
- Robot Scientist Machines based on Artificial Intelligence for exploitation of Massive Data experiments in Big Science.
- New double-tube pipes coupling for Remote Handling.

MARKETS

Nuclear / Space / Energy / Life Sciences, Primary Resources

QUALITY CERTIFICATIONS, NUCLEAR QUALIFICATIONS

Procedures started for ISO9001, 14025 (and others)

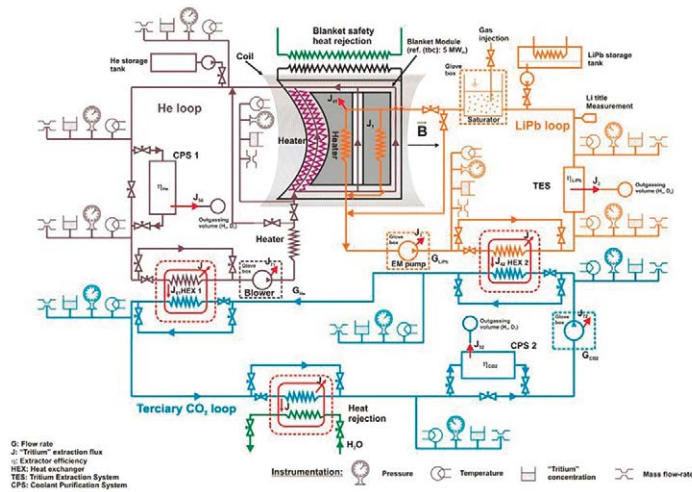

Advanced loops (Liquid Metal, Helium, SC CO₂) for high power extraction

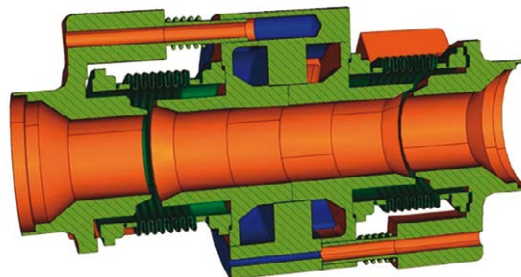

Design and detailed engineered double pipe connector for fast remote handling



WE LASER
THE NEW INDUSTRY

COMPANY NAME	FYLA LASER s.l.
ADDRESS	Ronda Guglielmo Marconi 14, 46980 Paterna (Spain)
WEB	www.FYLA.com
TURNOVER	> 1 Million in year 2021
EMPLOYEES	20 in year 2022
SME	YES
CONTACT PERSON	Ismael Almazán Fernández
	POSITION Chief Executive Officer
	PHONE 0034 672774055
	EMAIL ialmazan@fyla.com

COMPANY ACTIVITIES AND SKILLS

FYLA laser s.l. develops unique and singular all fiber - ultrafast pulsed lasers. Our products are focused and installed into high-end sectors and applications targets as Industrial metrology, Semiconductors advanced processing, FSO/fiber optical communications for . civil, defense and security, and many others into the whole value chain, together with large scientific institutions and initiatives, as key clients and partners, covering all kind of photonics based research, from fundamental to applied research developments, trough the use and integration of our proprietary all fiber lasers.

LARGE SCIENTIFIC FACILITIES AND NATIONAL RESEARCH FACILITIES CONTRACTS

[UV – Institute of Material Sciences] – Supply of a pulsated laser for the Photonics and Semiconductors Group (FOSE) (2021)

[IFCA CSIC] - Development and Supply of a Femtosecond Laser for Two photon absorption (2019.2020)

[CERN] - Development and Supply of a Femtosecond Laser for a TPA- TCT System (year 2018/2019)

R&D PROJECTS

IMDITA 2016/146: The main objective of this project is to develop an integrated laser lighting equipment for high-resolution biological-clinical microscopy equipment, such as time-resolved fluorescence microscopy (FLIM) and Multiphoton microscopy (MPM)

LASERCOMB: The main objective of the project is the development and market uptake of a fibre laser frequency comb (LASERCOMB) that will enable the new communication paradigm based on EONs and Super-Channels. The project has received funding from the call SME INSTRUMENT of the European Union's Horizon 2020 program under the grant agreement N° 826882.

FEMTOCOLORS: The main goal of this project is the recruitment of a postdoctoral researcher from other countries (not Spain) to explore an innovation business idea: the development of a Femtosecond (Fs) Temporally Coherent Supercontinuum (SC) Fiber Laser for

Multi-Photon Microscopy (MPM). FYLA LASER S.L. has recruited a highly qualified specialist in photonics, that is not available in the Spanish job market, but whose knowledge has been crucial to open up opportunities for innovation and significant growth for the enterprise. "This project has received funding from the European Union's Horizon 2020 research and innovation programme under grant agreement No 739697"

IMDIGA/2017/98: The goal of the project is to optimize the laser development process by using advanced design, calculation, simulation and analysis tools. To do this, FYLA will implement new technologies specialized in the design process (CAD) of lasers and their components, as well as in the calculation, analysis and simulation of their properties (CAM - CAE).

DOWLPUL – EUREKA – (SOUTH KOREA – SPAIN) Development of femtosecond laser based free-shape WLCSP (Wafer level chip size packaging) manufacturing system for advanced semiconductors.

MARKETS

Nuclear / Defense / Space / Big Science



Optical assembly

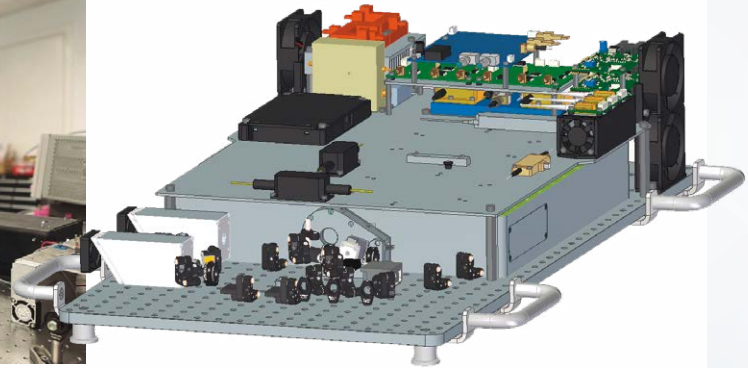

Integrated OEM system for WLCSP (Wafer level chip size packaging)

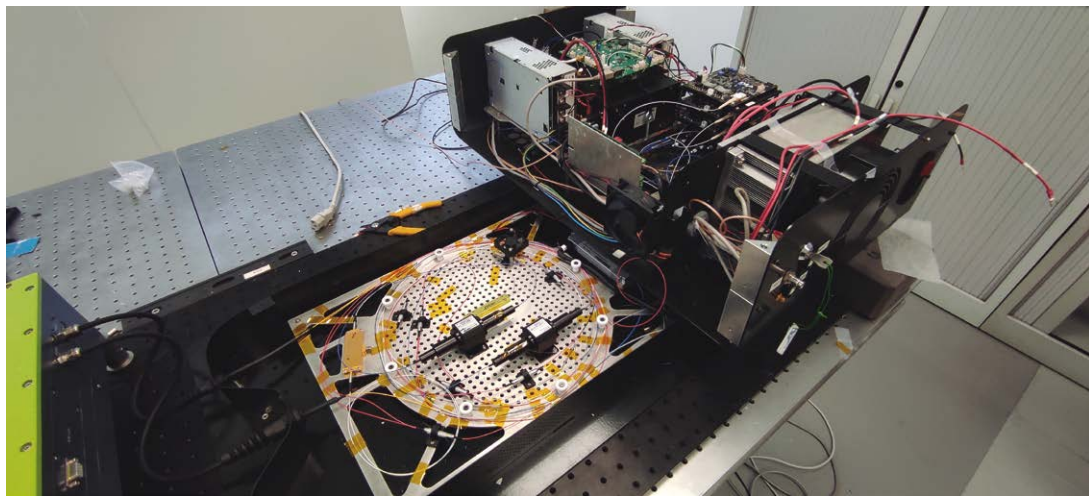

Beta system for WLCSP (Wafer level chip size packaging) processing

COMPANY NAME
ADDRESS

GDES
Ronda Auguste y Louis Lumière 15.
Parque Tecnológico 46980, Paterna (Valencia) SPAIN
+34 963 540 300

Phone

WEB

www.gdes.com

TURNOVER

€ 124,5 M in year 2021

EMPLOYEES

1,700 in year 2021

CONTACT PERSON

Nelia Martínez

POSITION Tender Coordination Director

PHONE +34 679 465 630

EMAIL n.martinez@gdes.com

COMPANY ACTIVITIES AND SKILLS

GDES performs surface treatment work for important national and international customers in the nuclear, petrochemical and industrial sectors through the GDES Revanti brand. GDES (Grupo Dominguis Energy Services) is a Spanish family-owned Group with international expertise in nuclear maintenance, surface treatments, decommissioning, radiation protection, services for the wind power industry, energy efficiency and photovoltaics, logistics and emergency response.

Since 2020, GDES has incorporated Digital Transformation and Business 4.0 into its activity, accompanying companies in the digitisation of the industry for more agile and intelligent decision-making, turning data into profitability.

Its degree of diversification positions the group as one of the companies with the most promising outlook in the energy market (nuclear, fossil and renewable, petrochemical and gas).

GDES, founded in 1932, currently has a workforce of more than 1,700 professionals worldwide. This is a highly qualified customer-orientated team that provides added value solutions adapted to the specific needs of each project.

With its strong commitment to research, development and innovation, GDES has established itself as a pioneering company in technological developments adapted to specific projects and needs.

One of its main areas of growth is in its commitment to technological development and innovation with the aim of extending its operational field, strengthening continuous improvement and maintaining its support to clients whenever new needs arise.

LARGE SCIENTIFIC FACILITIES AND NATIONAL RESEARCH FACILITIES CONTRACTS

[F4E] Contract for painting and coating works for the tokamak building (11), tritium building (14) and diagnostics building (74) (2018-present). Application of different types of coatings, combining scaffolding, auxiliary resources and rope access work over a total area

of 120,000 m², on both the Tokamak building and its two annex buildings, which will be used to achieve a deuterium-tritium plasma.

Properties of the different coatings: Decontaminable and non-decontaminable, anti-carbonation, high resistance to chemicals and heavy traffic, high resistance to irradiation, additional electrostatic conductivity requirements, resistant to oils and specific chemical elements.

[EDF] Coating system for the improvement of sealing and structural reinforcement for long-term operation of nuclear power plants. (2016-2019). Development of a new coating system specifically for EDF.

The added value comes from the real capacity of our system (SIKAWRAP 230C.) to solve a new requirement not raised until now, and whose resolution guarantees the operation of NPPs under the most recent regulations of international nuclear safety.

Four different interventions: NPP Cattenom 3: 50 m² (2016), NPP Flamanville 2: 2400 m² (2017), NPP Flamanville 1: 4500 m² (2018), NPP Flamanville 2: 3600m² (2019) covering 10,500 m² of surface area.

MARKETS

Nuclear

QUALITY CERTIFICATIONS, NUCLEAR QUALIFICATIONS

ISO 9001 / ISO 14001 / CEFRI



GDES Revanti - Tokamak Building- ITER



GDES Revanti - Corrosion protection primers, maintenance, paints and coatings. Blayais NPP



GDES Revanti - Corrosion protection primers, maintenance, paints and coatings

COMPANY NAME	GMV
ADDRESS	C/ Isaac Newton 11, Parque Tecnológico de Madrid, 28760 Tres Cantos (Madrid)
WEB	www.gmv.com
TURNOVER	256M€ in year 2021
EMPLOYEES	2557 in year 2021
SME	NO
CONTACT PERSON	Victor Gaspar
	POSITION Business Partner
	PHONE +34918072100
	EMAIL vgaspar@gmv.com

COMPANY ACTIVITIES AND SKILLS

GMV is a privately owned technological business group with an international presence. Founded in 1984, GMV offers its solutions, services and products in very diverse technologically-advanced sectors, including space, big science and information technologies.

With respect to Big Science, GMV's current offer via services contracts or projects includes development and Implementation of Central/Local/User Control Centers; Instruments processing, monitoring and control, and calibration; Data Processing Framework: Automatic Process Execution, Monitoring and Control (Event driven/Data driven), Multi-Sensor Processing Environment, Automatic Resources Reallocation, Algorithm Development and Validation, Support Transparent Scalability, Data Fusion and Data Mining, Archive, Catalogue and Dissemination; Application of multivariate analysis (PLS: Partial Least Squares regression) for predictive maintenance; Quantum computing; Advanced machine vision algorithms: optical tracking, pose estimation and navigation algorithms; Visualization, Validation & Analysis Tools. Simulators for R&D, Analysis, Training and Ops support; Planning and Scheduling Solutions; Custom HW/SW Development and Independent Hardware/Software Verification; Specialized Engineering Services, including Project Management Support and System Integration, Verification & Qualification and RAMS Analysis; Autonomous robotics solutions; Robotic Test Facility (platform-art); Physical and Cybersecurity solutions; Quantum resistant cryptography; Operation and support services 7x24

LARGE SCIENTIFIC FACILITIES AND NATIONAL RESEARCH FACILITIES CONTRACTS

[ESS] Framework Consultancy Agreement with two contracts: Support to ESS Integrated Control System Division with embedded engineer (2018) and network engineer (2019)

[ITER Org] Development, Maintenance and Support Services for the NDS Driver for MTCA Devices in the context of their use in CODAC Core System (2018)

[ESS] Provision of Integration Services for ESS Integrated Control Systems (2018)

[JAEA] Development, integration and test of Local Control Systems to the LIPAC Central Control System (2017)

[ESA/Airbus] Scatterometer Ground Processor Simulator & Prototype Tools in MetOp-SG

(2016) [JAEA] Engineering Support for IFMIF/LIPAc Control System Integration (2016)

[Eumetsat] EPS-SG Mission Control and Operations Support (2016)

[ESA] Design of the Framework Planning System for ESA's Science Missions (2016) [ITER Org] NDS Core Software Support for CODAC Core System (2016)

[ITER Org] Remote Handling Engineering Support, in consortium (2015)

[ESA] LISA Pathfinder (gravitational waves) Science Data Management Support (2015)

[ESA] SWARM (magnetic measurements) System-Performance Simulator / Operational Instrument Data Processor (2015)

R&D PROJECTS

[CDTI] Quantum computing applied to strategic industries (2021)

[CDTI] VirtualPAC, Deployment, management and secure operation of control systems involved in the control and operational network of an industrial plant (2019)

[EC] ERGO, European Robotic Goal-Oriented Autonomous Controller (2018)

[CDTI/CIEN] PRODUCTIO, PROductivity INdUstrial EnhanCement through enabling Technologies (2017)

[CDTI/CIEN] Accelerators and Associated Technologies for Big Scientific Facilities (2017)

MARKETS

Nuclear / Defense / Automotive / Naval / Aeronautics / Space / Energy / Oil & gas / ITC

QUALITY CERTIFICATIONS, NUCLEAR QUALIFICATIONS

ISO 9001, ISO 14001, CMMI Level 5, UNE-EN 9100, PECAL/AQAP 2110-2210-2310, UNE-ISO/IEC 20000-1, UNE-ISO/IEC 27001, ISO 22301, UNE 166002, NRTL-C/US, UN/ECE N.10

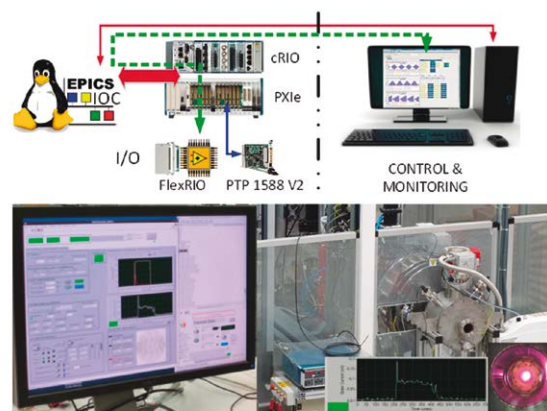

Instrumentation and Control for Large Scientific Facilities

COMPANY NAME
ADDRESS

GREENLIGHT SOLUTIONS S.L.
 Avenida Somosierra 12, portal B, planta 2, oficina F, San Sebastián de los Reyes, 28703 Madrid (Spain)

WEB
TURNOVER
EMPLOYEES

www.greenlightsl.com
 256 k€ in 2021
 3 full-time and 2 part-time in year 2022

SME
CONTACT PERSON

Yes
Ana Manzanares Ituarte
POSITION Unique administrator
PHONE 34 655 050 260 / 34 910130814
EMAIL a.manzanares@greenlightsl.com

COMPANY ACTIVITIES AND SKILLS

GREENLIGHT SOLUTIONS is a key company in the field of optical design and engineering (image formation) and photonics (radiation generation, conduction, and detection). Especially focused on solving specific problems of our customers, we have been expanding our capabilities to additionally offer electrical, piezoelectric, mechanical and software solutions. We offer design, manufacture, installation/assembly and commissioning of diagnostic imaging systems for magnetic confinement fusion devices, electromechanical systems and UV-VIS spectroscopy systems for space. We also are specialised in product engineering activities with piezoelectric technology: shutters for synchrotrons, elimination of noise from railway tracks or control of robotic arms for nanofabrication.

LARGE SCIENTIFIC FACILITIES AND NATIONAL RESEARCH FACILITIES CONTRACTS

[CLPU] Supply of custom-made circular-shape optical tables, motorized slit, THz detectors, laser and energy power meters, motorized linear stages for vacuum for the Extreme Optics Group and Scientific Area (2022, 2021, 2017, 2016, 2015, 2014)

[ICMAB] Optomechanical system for organic transistor manufacturing (2022)

[INTA] Manufacture of custom-made optical tables and several optomechanics and optics items (2022- 2012)

[AEMET] Design and manufacture of an optical protection window and its support frame for the micropulsed LIDAR CE376 in Izaña Observatory (2021)

[IAC] Assessment of optical design of refocusing blocks for the Multi Conjugated Adaptive Optics (MCAO) and supply the linear stages to make the final refocusing (2021, 2020), Requirement to apply a NIR AR coating at the end of glass fiber optics bundle connector (2018)

[ICMAB] Multiplatform optomechanical system for 2D flakes transfer system (2021)

[ALBA CELLS] Manufacture of square first surface mirrors with a hole in the centre (2020), Manufacture of collimating achromatic doublets and first surface mirror (2017), Supply of linear translation stages for lab (2016), Supply of pneumatic optical table for lab (2015), Supply of fast piezo shutters for the RX lines (2012, 2010)

[LEITAT] Supply of several pneumatic optical tables, motorized iris diaphragm and a laminar

flow workstation for the Renewable Energies Area and the Energy Conversion and Photonics Area (2020, 2018, 2017)

[CIEMAT] Manufacture of MgF₂ windows for detection of dark energy (2019)

[INL] Optomechanical set up the ultrafast bio and nano photonics laboratory (2019)

[CEM] Supply of several optomechanical components for Radiation Thermometry Lab (2017, 2016, 2014)

[IAA] Fused silica windows dummies manufacturing, custom-made 5 axes motorized stage manufacturing, manufacture of several cryostat windows, supply of pitch&yaw stages for Instrumentation Unit (2016, 2011, 2009)

[IMDEA] Supply of optical tables, optomechanical supports and stages for Materials Department and Energy Department (2015)

[CSIC-IO] Optical and opto-mechanical design, manufacturing, assembly, and testing of a patented calibration device for spectrometer "Calespio" (2012)

[IPCE] Design, manufacture, and assembly of a 2D scanning system for hyperspectral image studies of art pieces (2011)

[CIEMAT-LNF] | [CLPU] | [IAA] | [IAC] |[INTA-CAB] Training in Zemax Optical Studio (Introductory and/or Advanced) (2022,2021,2020,2017,2016, 2015,2014)

R&D PROJECTS

[CIEMAT, TJII] Updating of the FIR imaging system for neutral impact detection

[JET] Fast intensified camera for plasma physics studies, CDT Project Update of VIS-IR imaging diagnostic systems for wall protection and physical studies, Calculations of the impact of wall reflections on optical measurements

[ITER] Feasibility study and optical design of wide-angle equatorial vision systems in VIS-IR (interspace and portcell zone), Design and photonic study of Core Charge Exchange Recombination diagnosis

MARKETS

Nuclear / Defense / Automotive / Naval / Aeronautics / Space / Energy / Oil & gas

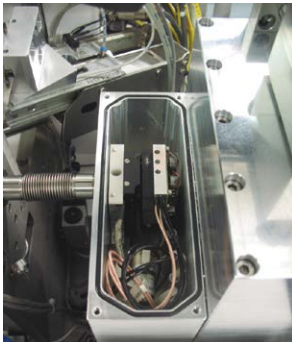

ALBA - Piezo electric shutter @GLS

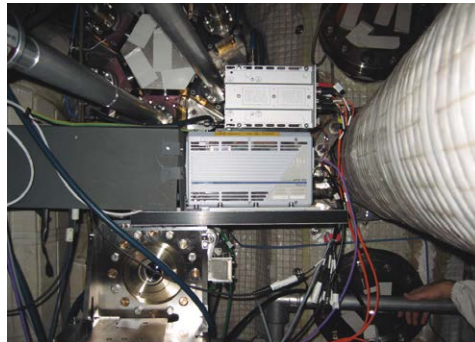

JET - Spectroscopic fast camera diagnostic KL8A @GLS



LEITAT - Laminar flow workstation @GLS



COMPANY NAME	GTD INGENIERÍA DE SISTEMAS Y DE SOFTWARE, S.A.
ADDRESS	Garcia i Faria, 17 – E08005 Barcelona
WEB	www.gtd.eu
TURNOVER	32,7 M in year 2021
EMPLOYEES	266 in year 2021
SME	NO
CONTACT PERSON	Ilona Siewiera POSITION Business Development Director - GTD Science, Infrastructures & Robotics PHONE +34 934 939 300 EMAIL Ilona.siewiera@gtd.eu Ricardo Bennassar POSITION Sales Manager – GTD Sistemas de Información PHONE +34 934 939 300 EMAIL ricardo.bennassar@gtd.eu

COMPANY ACTIVITIES AND SKILLS

GTD is a global technology company committed with the Design, Integration and Operation of high-value, complex, “mission-critical” Applications and Systems all over the world. The main activity sectors of GTD are Big Science, Space, Robotics, Infrastructures, Aeronautics, Defense & Security, Logistics & Transportation. Our knowledge areas range from control process, embedded safety FPGAs, real time control systems, safety critical software, supervision & control rooms, industry 4.0, decision support and data analytics solutions. We bring together the combined expertise in the areas of system and software engineering for High Energy Physics laboratories, Telescopes, Fusion Reactors, Remote Handling, Space Ground Systems, Embedded Systems for Space Vehicles and Satellites.

LARGE SCIENTIFIC FACILITIES AND NATIONAL RESEARCH FACILITIES CONTRACTS

[ITER] Framework Contracts for Central Safety system (CSS) Support Services - System engineering services (2022-2027) - Prototypes and early systems development services (2022-2027) [ITER] Framework Contract for CODAC Core System (CCS) Software Maintenance (2021 – 2026)

[ITER – ESTEYCO] Framework Contract for Tokamak System Monitoring (2020 - 2025)

[F4E – ALTER] Framework Contract for Bespoke Electronics (2021-2026)

[F4E] GENROBOT Command Control (2020-2022)

[F4E] Magnetics Diagnostic Plant Controller Integration (2021-2023)

[F4E] FECDS-TCCS I&C MRR and First-of-a-kind Manufacturing (2021-2023)

[F4E] Front End Cryogenic Distribution System (FECDS) I&C HW and SW (2019-2020)

[F4E] Torus and Cryostat Cryopumping System (TCCS) I&C Integration with FEDCS (2019-2020)

- [CTA] Cybersecurity Consultancy (2019)
- [ITER] Framework Contract for CODAC Development and Maintenance (2018-2022)
- [F4E] Remote Handling: GENROBOT Test Bench Validation and integration at DTP2 (2018-2020)
- [F4E] Advanced Conceptual, Preliminary and Final Design of the Magnetic Diagnostic plant system controller hardware and software (2018-2020)
- [ESA] Data Circulation and Dissemination (2018)
- [ESO] Alma Common Software ACS (2018)
- [F4E] Framework Contract for Instrumentation & Control Services (2017-2022)
- [ITER-FERROVIAL] Control and Supervision for Load Centers and TB05, TB06 Buildings (2017-2020)
- [CNES] Ariane Group Ariane 6 Control Bench Family (2016-2032)
- [EUMETSAT MTG Level 2 Processing Facility (2016-2022)
- [F4E] Remote Handling: GENROBOT Development (2016-2020)
- [F4E] Instrumentation, Control & (Fast) Protection Systems for European Gyrotron test facility and ECT - FALCON (2016-2020)
- [ITER-OMEGA] Control and Supervision for TB04 Buildings (2016-2020)
- [F4E] Design and implementation of the Alarm Survey System extension (2016-2017)
- [F4E] Development of HMI and PLC interface (PSH) for LN2 plant (2016)
- [F4E] Preliminary Design of the Instrumentation and Control system for the HCLL PbLi Loop (2015-2016)
- [ESA] International Gateway, I-HAB Application Software.

R&D PROJECTS

- [H2020] SAMMBA - Standard And Modular Microlauncher BAsed services (2019)
- [H2020 2020] ENVOL - European Newspace Vertical Orbital Launcher (2019)
- [CDTI CriticalLogic] IDI-20160121 – Ultrafast functional safety protection system with high reliability and availability (2016-2017)

MARKETS

Nuclear / Defense / Naval / Aeronautics /
Space / Energy / Robotics, Infrastructures

QUALITY CERTIFICATIONS, NUCLEAR QUALIFICATIONS

ISO 9001 / EN9100 / AQAP2110/2210 /
CMMI CL3

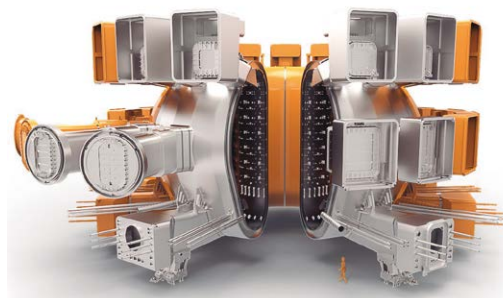

ITER vacuum vessel - (C) ITER Organization -
www.iter.org



COMPANY NAME	GUTMAR
ADDRESS	Avinguda de Cerdanyola, 97, 101, 08173 Sant Cugat del Vallès, Barcelona
WEB	www.gutmar.com
TURNOVER	11 MM in year 2021
EMPLOYEES	95 in year 2022
SME	YES
CONTACT PERSON	Iván Olivella
	POSITION R+D+I Manager
	PHONE (+34) 93 223 48 23
	EMAIL iolivella@gutmar.es

COMPANY ACTIVITIES AND SKILLS

Since its foundation in 1951, GUTMAR has been specialized in precision machining and assembly of mechanical parts and high technology subsystems, in order to satisfy the needs of its customers by offering them a complete service, ranging from product development, machining, heat, surface and painting treatments, to final assembly and after-sales service.

Gutmar is positioned as a top-tier supplier for major European aerospace companies like Airbus. We work in leading sectors as aeronautics, space, maritime, robotics and recently in the fusion energy sector. Gutmar develops and leads international technological innovation projects seeking a long-term win-win relationship with customers.

Gutmar offers:

- One stop shop service: from concept design to manufacturing, including maintenance and repair through the life cycle of our products
- Precision machining: We use the highest technology in industrial equipment (More than 50 machines, machining centers of 3, 5 and 9 axes, lathe, milling, 3D dimensional, ...).
- Mechatronic assemblies: High accuracy mechatronic systems.
- Wide variety of welding processes, with facilities and equipment that can be adapted to our customers' needs.
- Welding assemblies: Delivery of completely assembled, painted and adhesive structures.
- Prototype manufacturing capacity (short and large series).
- Special tooling: Engineering Design & Manufacturing.
- Precision Dimensional Metrology Laboratory, fully equipped with cutting edge technology.
- Multidisciplinary team capable to move to client's facilities to operate, make final adjustments and commissioning.

Gutmar covers: Manufacturing & Assembly Aerospace, Aeronautics, Défense, Automotive, Robotics, Equipment, Electronics, Automation, Mechatronic Engineering, Special Projects, R+D+I, Brazing (Oven Hard Welding) MAG, MIG & GMAW MIG. Brazing TIG, GTAW & SMAW, Process engineering, Mechanical and electrical engineering, Mech. and Elec. installation, PLC Programming, Robot Programming, Commissioning

LARGE SCIENTIFIC FACILITIES AND NATIONAL RESEARCH FACILITIES CONTRACTS

[F4E] F4E-OPE-1150: IDES & IVS In-Divertor Electrical Service (IDES) Final design, Manufacturing & supply Connectors, Sensors, JB, Shunts and Mineral Insulated (MI) cabling for ITER diagnostics sensors In-Vessel Supports (IVS) Manufacturing & Supply for MI Cabling.

[F4E] F4E-OPE- OPE-0982: Design, manufacturing & supply Leak Detection systems

[F4E] F4E-OPE - OPE-0885: Manufacture of Diamond Window Prototypes

R&D PROJECTS

PROFIT ALELLA: Electrochemical, Laser, Cvd and Peo Alternatives for The Generation and Enhancement Of Heavy Metal Substitute Coatings.

PROFIT RAMPE: Alternatives to chrome and cadmium coatings, as well as to the currently employed primer and chemical conversion treatments. These alternatives must be environmentally acceptable.

BE-COOL: Alternative Lubrication Systems based on Low-Cost Cryogenic Gases (Co₂ and Ln₂).

HYDROBOND: New cost-effective superhydrophobic coatings with enhanced bond strength and wear resistance for application in large wind turbine blades.

REHABILITA: Research project on Disruptive Technologies for the Rehabilitation of the Future for the rehabilitation of the 21st century that will allow the Spanish Health sector to respond to the challenges faced by European societies in general and the Spanish society in particular.

CDTI 8 x8 Hybrid propulsion 8x8 vehicle project.

SAMHU Airborne Humidity Sensor Project

MARKETS

Nuclear / Defense / Automotive / Naval / Aeronautics / Space / Energy / Oil & gas / Medical devices

QUALITY CERTIFICATIONS, NUCLEAR QUALIFICATIONS

ISO 9001

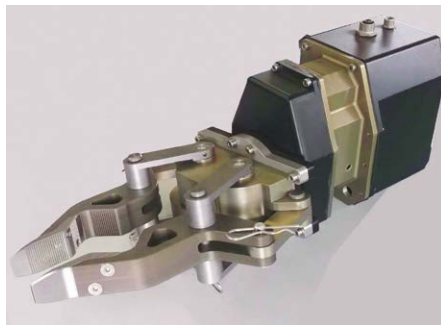

Robotic gripper



Satellite parts



COMPANY NAME	HILFA
ADDRESS	Barrio Arteagoiti, N° 8, 48970 Basauri, Vizcaya
WEB	www.hilfa.com
TURNOVER	3.985.000 in year 2021
EMPLOYEES	45 in year 2021
SME	YES
CONTACT PERSON	Igor Zarandona Vega
	POSITION MANAGING DIRECTOR
	PHONE +34 690 933 823
	EMAIL izarandona@hilfa.com

COMPANY ACTIVITIES AND SKILLS

Manufacturing of Telescope Domo.

Dedicated to the manufacturing of heavy mechanical equipments including, welding , machining and final integration (assembly).

Precision machining.

LARGE SCIENTIFIC FACILITIES AND NATIONAL RESEARCH FACILITIES CONTRACTS

[ELT – IDOM] Prefocal Station for ELT (2022)

[Tecnalia] Harslab flotating offshore laboratory (2021)

[CEA] Structures containers et et des bancs mécaniques du tomographe Tomis (2021)

[Siemens] Wind turbine main bearing test bench (2020)

[VMC Technology Centre] Onshore wind turbines rotor rig for LM wind power (2018)

[GTC] Manufacturing of boggies (2016)

[CERN] Vacuum chamber support (2015)

[ITER] Toroidal Field Coils Bench (2014-2015)

[ATST]: Manufacturing of Domo (2012-2013)

MARKETS

Nuclear / Defense / Automotive / Naval / Aeronautics /Space / Energy / Oil & gas

QUALITY CERTIFICATIONS, NUCLEAR QUALIFICATIONS

ASME / ISO 9001



ATST telescope dome



ATST telescope dome



HAPT Test Bench (Fraunhofer)



HAPT Test Bench (Fraunhofer)



COMPANY NAME	IBERDROLA GENERACIÓN NUCLEAR
ADDRESS	C/Tomás Redondo 1, Madrid
WEB	www.iberdrola.es
TURNOVER	1000M€ in year 2021
EMPLOYEES	1000 in year 2021
SME	NO
CONTACT PERSON	Ignacio Hermana Mendioroz
	POSITION Servicios A Centrales Nucleares-Servicios Técnicos Nucleares
	PHONE +34638091721
	EMAIL ihm@iberdrola.es

COMPANY ACTIVITIES AND SKILLS

The company has 1 nuclear power plant license (Cofrentes), and has ownership participation in six more (Almaraz I&II, Trillo, Vandellós II, Ascó II and S.M. de Garoña), owning a total of 3.060MWe.

It has some technical and engineering skills inherited from Iberdrola Engineering and Construction, the former engineering branch from Iberdrola that was previously in the CDTI catalogue.

LARGE SCIENTIFIC FACILITIES AND NATIONAL RESEARCH FACILITIES CONTRACTS

Iberdrola Engineering and construction had some relevant contracts in ITER, mainly the supply of Toroidal Field Coils and the supply of First Wall Panels prototypes.

[F4E] Manufacturing of a Full-scale Prototype of the ITER NHF First Wall (FW) Panel (2014 – 2019): These panels comprise a stainless steel and CuCrZr copper alloy heatsink covered with beryllium tiles, designed to meet a complex set of requirements which include thermal and mechanical loads. This prototype will qualify series production of these panels.

[F4E] Supply contract for the Manufacturing of 10 Toroidal Field Coils Winding Packs (2010-2020). The Winding Packs (WP) that belongs to the ITER fusion magnet system which consists of 18 “D” shaped coils. Each WP is measuring approximately 14 X 9 m and weighing 110 tons. In order to complete each WP it has been required to develop novel and sophisticated tooling to be constructed on a large scale.

MARKETS

Nuclear / Energy

QUALITY CERTIFICATIONS, NUCLEAR QUALIFICATIONS

ASME, ISO 9001, ISO 14001, Innovation certificate UNE 166002, OSHAS 18001, Homologation by Supplier Evaluation Group



First Winding Pack with representatives of all parties involved

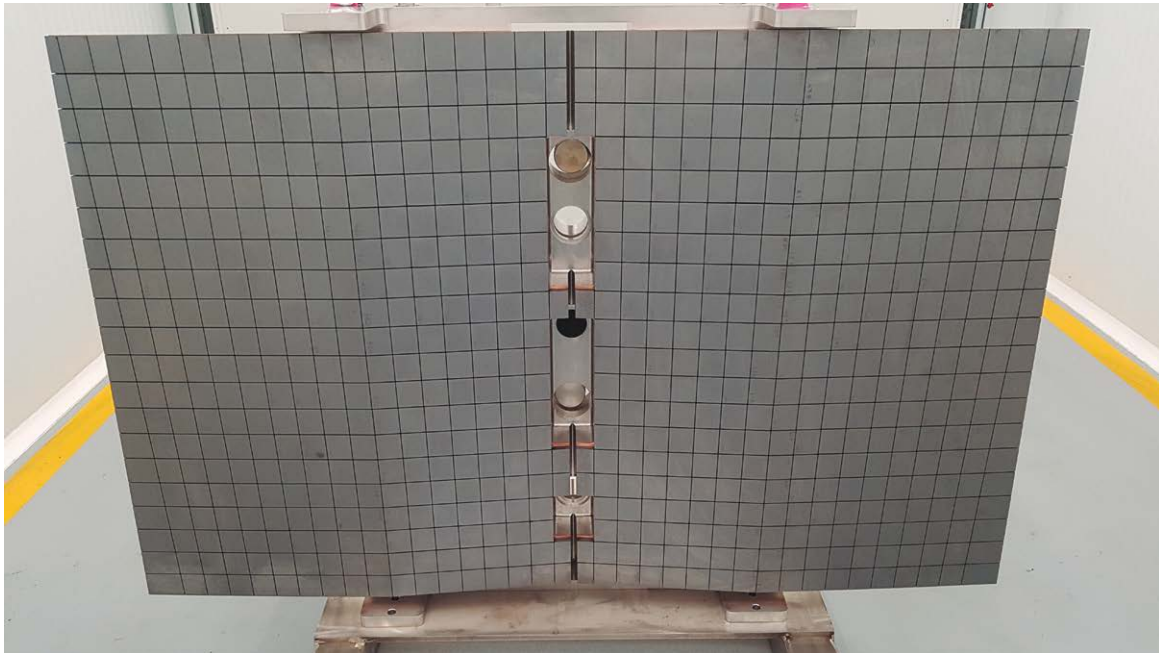

Finished First Wall Panel Semi Prototype

COMPANY NAME	Ingeniería y Diseño Europeo S.A. (IDESA)
ADDRESS	Paque Científico Tecnológico de Gijón C/Profesor Potter nº 105 - 33203 Gijón/Asturias/Spain
WEB	www.idesa.net
TURNOVER	45M€ in year 2021
EMPLOYEES	108 in year 2021
SME	NO
CONTACT PERSON	Víctor Jesús Martínez Pérez
	POSITION Operations and R&D Director
	PHONE (+34) 985 175 705
	EMAIL idi@idesa.net

COMPANY ACTIVITIES AND SKILLS

Founded in 1993 as a technical and commercial office to support local fabrication shops in the oil and gas business, IDESA has become one of the most recognised and respected companies for the design, manufacture and supply of static and modular equipment worldwide.

IDESA is an engineering and manufacturing company, one of the leading suppliers of large manufactured equipment such as Coke Drums, Vacuum Columns, Fractionators, Reactors and FCC & FCK units, as well as all types of Vessels and Drums.

With 48'000 m2 of indoor manufacturing areas and its privileged location close to the Port of Aviles, IDESA satisfies any demand in the Oil&Gas and Renewable Energy sectors (LNG, CO2, H2).

The company has a long experience and reputation in the demanding energy sector and its processes and quality procedures are the most suitable to operate in the sector of Large Scientific and National Research Facilities.

Since May 2014, Idesa is part of GRUPO DANIEL ALONSO (GDA).

LARGE SCIENTIFIC FACILITIES AND NATIONAL RESEARCH FACILITIES CONTRACT

A) MANUFACTURING OF CRYOSTAT BASE FOR JT60-SA PROJECT

In the context of JT-60Sa Project developed in Naka (Japan), IDESA was awarded with the contract for the fabrication and shop assembly of the Cryostat Base. This structure, weighing around 300 ton and with a diameter of 12 meters, is an assembly comprising seven big stainless steel sectors, that are to be bolted together during final assembly in Japn There are three "lower level" 120° sectors (the Lower Structure sectors), and three "upper level" 120° sectors (the Double Ring sectors) resting on the Lower Structure Sectors. The seventh piece is the Cylindrical Shell, located inside the DR sectors, and resting onto the LS sectors. This solution was adopted in view of the dimensional restrictions to the final land transport between Hitachi Port and final destination at Naka site.

The thicknesses of the structure are mostly between 80 and 100 mm. Most of welds are butt or corner welds, full penetration type, so a great amount of weldment is involved. Thus, the control of the distorsion produced during welind activities was essential to fabricate a welded

structure that at a later stage can be machined within the required tolerances.

B) REVISION AND UPDATE OF SDC-IC CODE FOR ITER PROJECT

Several ITER components, referred to as in-vessel Components, are located inside the ITER Vacuum Vessel; they will be subjected to special operating and environmental conditions (neutron radiation, high heat fluxes, electromagnetic forces, etc.). The effects of irradiation on them, including embrittlement, swelling and creep, were not addressed in the existing commercial codes. These conditions are different from conditions in fission reactors and create challenging issues related to the design of these components. The tasks covered were: (a) Modification of design rules, incorporating rules from recently developed codes, and development of specific design rules to cover ITER specific issues and operational conditions, (b) Demonstration of consistency between design rules in SDC-IC and European standards used for manufacturing, in particular EN 13445; identifying areas where consistency is not provided, (c) Assessment of the compliance with the Essential Safety Requirements of the French Regulations (ESP and ESPN)

R&D PROJECTS

EU Horizon 2020 Programme under Grant Agreement no. 958303 – PENELOPE Project

EU 7th RTD Framework Programme – The HIPERWind Project

CDTI EEA GRANTS – Joints-Off | Low-Cost and High-Durable Offshore Foundation

LIFE+ CO2FORMARE | Use of CO2 as a substitute of chlorine-based chemicals used in O&M industrial processes for macrofouling remediation

LIFE+ BIOBALE | Development of a cogeneration demonstration plant from biomass forest bales

RFCS JABACO Project | Development of Modular Steel Jacket for Offshore Windfarms

RFCS REFOS Project | Life-Cycle Assessment of a Renewable Energy Multi-Purpose Floating Offshore System

H2020-NMBP-TR-IND-2020 PENELOPE Project | Closed-loop digital pipeline for a flexible and modular manufacturing of large components.

MARKETS

Energy / Oil & gas

**QUALITY CERTIFICATIONS,
NUCLEAR QUALIFICATIONS**

ASME / IISO 9001 / ISO 14001 / ISO 45001 / OHSAS 18001 / ISO 3834 / EN 1090 / ACHILLES UTILITIES NC / RE-



Cryostat Base

COMPANY NAME	IDOM
ADDRESS	Avenida Zarandoa 23, 48015 Bilbao
WEB	www.idom.com/ada
TURNOVER	324MEUR in year 2021
EMPLOYEES	4300 in year 2021
SME	YES
CONTACT PERSON	Amaia Zarraoa Garmendia
	POSITION Head of Strategic Development IDOM ADA
	PHONE +34 944797676
	EMAIL amaia@idom.com

PRO ACHILLES

COMPANY ACTIVITIES AND SKILLS

IDOM is an international firm specializing in Engineering, Architecture and Consulting. IDOM operates globally in areas such as power generation, oil & gas, renewable and alternative energies, manufacturing industry, civil infrastructures, nuclear plants, large technological and scientific facilities, architecture and unique challenging engineering projects.

IDOM ADA leads the company activity in technologically advanced and challenging projects involving applied mechanics, structural design, electronics & control.

IDOM ADA fully develops INSTRUMENTS AND FACILITIES for astronomers, nuclear and particle physicists, researchers in atomic energy, medicine and others. In these fields, there is always a demand for the most advanced technology and innovative solutions, time and again involving a breakthrough from what was used before. As important as the technical challenge, is the definition and development of the project up to the construction and commissioning of the facilities in time and within budget. And this is our commitment.

LARGE SCIENTIFIC FACILITIES AND NATIONAL RESEARCH FACILITIES CONTRACTS

[F4E] EC Upper Launcher Integrator & Ex Vessel Waveguides (2022-2027)

[ESO] Extremely Large Telescope (ELT) M1 Local Coherencer (2021-2024)

[F4E] Core Plasma Thomson Scattering (CPTS) Diagnostic (2021-2023)

[IAC] European Solar Telescope (EST) Mount, Pier and Enclosure Preliminary Design (2021-2022)

[ESO] Extremely Large Telescope (ELT) Prefocal Station A Main System (2018-2024)

[UK Atomic Energy Authority/ESS] ESS Active Cells Confinement and Shielding: Component Transfer Hatch (2019-2021)

[VTT/CEA] Design, Manufacturing and Commissioning of,

- Hot Cell Gamma and X-ray (HGXR) Equipment in the ECE Hot Cell JHR (2016-2020)
- two units of Underwater Gamma and X-ray (UGXR) Collimators (2015-2020)

- two units of Underwater Gamma and X-ray (UGXR) Benches (2014-2020)

[GRANTECAN] Cassegrain Station (Instrument Rotator + A&G Optomechanics) Design and Fabrication (2017-2019)

[IAC] William Herschel Telescope (WHT) Prime Focus Rotator (2017-2019)

[CFHT Corporation] Concept Design of the MSE Telescope Structure (2016- 2017)

[F4E] Integration Design of Diagnostics into ITER Ports (2014-)

[AURA] DKIST Enclosure Design, Fabrication, Factory Assembly and Testing (2010-2014)

[GRANTECAN] Folded Cassegrain Sets (Instrument Rotator + A&G Optomechanics) Design and Fabrication (2010-2012)

[ESS-Bilbao] High Power Spallation Target Development (2008-2011)

[ESO] E-ELT Dome and Foundations Preliminary and Final Design (FEED Study) (2007-2011)

[IAC] Design and Fabrication of QUIJOTE CMB Telescopes (2007-2015)

MARKETS

Nuclear / Defense / Space / Energy / Oil & gas

QUALITY CERTIFICATIONS, NUCLEAR QUALIFICATIONS

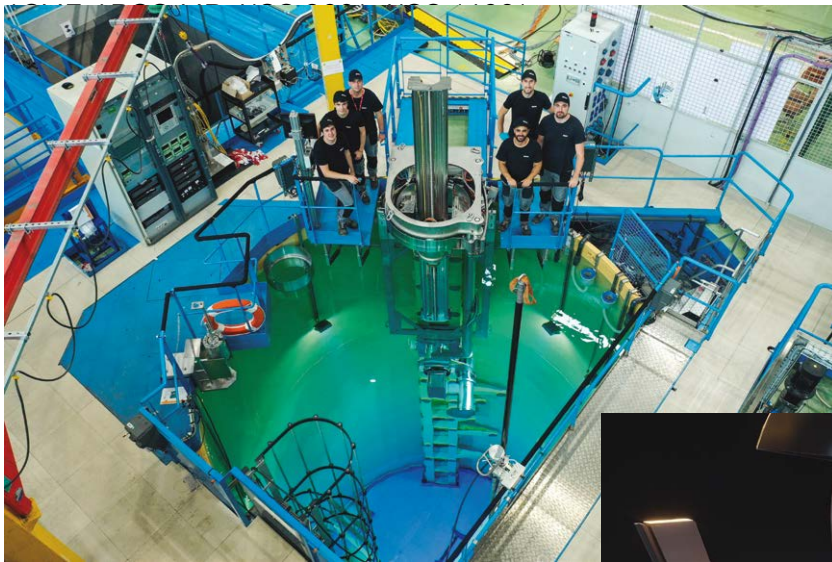

Jules Horowitz Reactor (JHR) UGXR Bench installed at Cessarine Pool during on-site acceptance tests

Extremely Large Telescope (ELT) Pre-focal Station

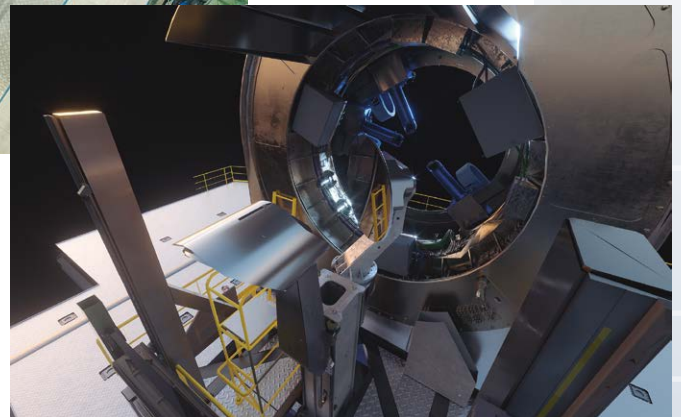



COMPANY NAME	FUNDACIÓN IDONIAL
ADDRESS	Parque Científico Tecnológico de Gijón, Zona INTRA. Avda. Jardín Botánico, 1345 33203 Gijón, Asturias
WEB	www.idonial.com
TURNOVER	9,3 M€ in year 2021
EMPLOYEES	158 in year 2021
SME	NO
CONTACT PERSON	M. Armindo Guerrero
	POSITION HEAD OF ENGINEERING AREA
	PHONE +34 985 129 120
	EMAIL armindo.guerrero@idonial.com

COMPANY ACTIVITIES AND SKILLS

IDONIAL is a Spanish private technological centre, with more than 30 years of experience. The center is multisectorial and carries out R&D&I activities from the following areas: Materials (metals, ceramics, plastics), Advanced Manufacturing (Additive Manufacturing, Welding), Digital Industry (Industry 4.0) and Engineering (Numerical Simulation, Mechanical and Electronic Engineering). In addition, relevant Technological Services backed by official accreditations are available.

The areas of specialization of interest for Large Scientific Infrastructures include:

- Steels and Metallic Alloys. development, fabrication routes and characterization to application. The activities performed deal with extending service life, optimising in-use behaviour, improving mechanical, wear or corrosion resistance, increasing their formability and weldability, new materials selection and application. Specialisation in fatigue & fracture mechanics studies.
- Welding Technologies. weldability studies, selection of the optimal welding parameters, design & validation of manufacturing technical instructions, manufacturing of special welded mockups and special NDT calibration blocks with advanced welding processes, global and conceptual manufacturing plans, as well as inspection plans. Wide range of techniques including robotic, FSW and laser hybrid welding.
- Engineering and Numerical Simulation. Structural, thermal and fluid-dynamics analyses by FEM&CFD; coupled analyses: thermo-hydraulic, thermo-mechanical. Welding process simulation, distortion prediction, selection of the optimal welding sequence. Large experience with different design codes (RCC-MR, RCC-MRx, ASME, etc), welded structures and complex settings.

LARGE SCIENTIFIC FACILITIES AND NATIONAL RESEARCH FACILITIES CONTRACTS

[ITER] Refilling and Blowout Tests on DFW Mock-Up (2022)

[ITER] Qualification Plan of TL-Isolation Shutter Valve (2022)

[ITER] Structural Integrity Evaluation of ECH Isolation Shutter Valve (2021-2022)

[ITER] PP Water Feedthroughs Manufacturing and Maintenance Feasibility (2020-2021)

[ITER] Manufacture a Prototype of a Generic EDFW (2019-2021)

[ITER] Mock-up for manufacturing feasibility demonstration of cooling implementation on vertical blades of the Modular Diagnostic Shielding Module. (2018-2019)

[ITER] Mock-up for manufacturing feasibility demonstration of cooling implementation on vertical blades of the Modular Diagnostic Shielding Module. (2018-2019)

[ITER] Development of (EC) Electrical Feedthroughs. (2017-2020)

[ITER] Thermal-hydraulic FE model of the integrated Equatorial Port Plugs. (2017-2018)

R&D PROJECTS:

[MANUNET] DAAMAS: Development of wire Arc Additive Manufacturing processes for Aeronautic large Structures (2020-22)

[H2020] RESERVIST: Repurposing manufacturing lines for providing products and services in case of spiking demand times

[RFCS] CIBER-POS: Virtual Design of Cyber-Physical Production Optimization Systems for Long Production Factories (2016-19)

[MANUNET] RED WELDS: Rapid Evaluation of Distortions in Welded Structures (2014-16)

[RFCS] MODELCOR: Modular Simulation Tool for In-Service Behaviour Prediction of the Cooling Water Systems of the Steelmaking Industry. (2014-17)

[Consolider Ingenio 2008] TECNOFUS: Programa de Tecnología de Fusión (2009-11)

MARKETS

Nuclear / Defense / Automotive / Naval / Aeronautics / Space / Energy / Oil & gas / Construction

**QUALITY
CERTIFICATIONS,
NUCLEAR
QUALIFICATIONS**

ASME / ISO 9001 /
ISO 17025 / ISO 17020

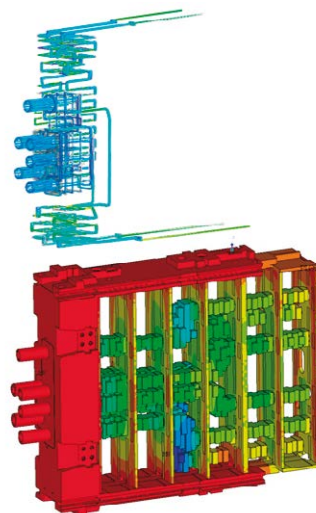

DSM. Velocity streamlines and temperature distribution



Port Plug water feedthroughs manufacturing and maintenance feasibility

COMPANY NAME	INDRA SISTEMAS S.A.
ADDRESS	Avda. Bruselas 35; Alcobendas 28108 - Madrid
WEB	www. Indra.es
TURNOVER	1.029.524M€ in year 2021
EMPLOYEES	6.732 in year 2021
SME	NO
CONTACT PERSON	Francesc Xavier Cabré Bozal
	POSITION Program Manager
	PHONE +934 630 497 / 629 25 14 08
	EMAIL xcabre@indra.es gestiondeinnovacion@indra.es

COMPANY ACTIVITIES AND SKILLS

Indra is one of the leading global technology and consulting companies and the technological partner for core business operations of its customers world-wide. It is a world-leader in providing proprietary solutions in specific segments in Transport and Defence markets, and a leading firm in Digital Transformation Consultancy and Information Technologies in Spain and Latin America through its affiliate Minsait. Its business model is based on a comprehensive range of proprietary products, with a high-value focus and with a high innovation component. In the 2018 financial year, Indra achieved revenue of €3.104 billion, with 43,000 employees, a local presence in 46 countries and business operations in over 140 countries.

Our specific skills for fusion projects are in the following areas: 1) Energy Technologies: Control technologies (I&C, SCADA, Data Acquisition), Metering systems, Modeling & Monitoring applications, Technical consultancy. 2) Space Technologies: Digital signal processing, Radio frequency, IP protocols and multimedia, Real-time, critical and embedded SW & HW, big DB. 3) Simulators (full scale and compact) & Automatic Test Facilities. 4) RADAR, RF & Microwave Design, RF Power Modules, SSPAs (Solid State Power Amplifiers, Amplifiers based on solid-state technology -LDMOS-). 5) Cross-Sectors Technologies: HW / FW Design, Critical SW Design, Electrical, Mechanical & Test Engineering, Electro-Optics. 6) Security Systems for critical infrastructures: consultancy, engineering, installation and support ; Video surveillance, access control, Biometrics, PSIM (Physical security integrated management)

LARGE SCIENTIFIC FACILITIES AND NATIONAL RESEARCH FACILITIES CONTRACTS

[CERN] Supply and installation of Site surveillance (SUSI) Access Control Systems – (2013 – 2021). Framework contract for all CERN sites, including videosurveillance, access to sites, buildings and specially secured areas.

[EUROFUSION]: Subtask ENS-6.1.6.0-T19-03: LIPAc RFPS Circulator control SW upgrade (2019-2020). Upgrade for the circulator control software in the Radiofrequency Modules. The new software version allows changing the parameters dynamically using a new interface.

[EUROFUSION]:Subtask ENS-6.1.6.0-T09-11: Support to LIPAc activities 2017: RF Power

system (2017-2018). Support on the activities at Rokkasho related to installation, check-out and commissioning of the RF Power System as well as to ensure the availability of the system during the LIPAc operation.

[F4E] F4E-OPE-0819: On site support for the commissioning of the RF Module SRF02 of the Sathori Test Stand (2017) placed in the CEA facilities, which aims to test and to validate the design of cavities before the assembly at Rokkasho.

[CERN] HNSciCloud-Helix Nebula The Science Cloud (2016-2017). establishment of a European hybrid cloud platform, Helix Nebula – the Science Cloud, to support the deployment of high-performance computing and big-data capabilities for scientific research.

[ITER ORGANIZATION] IO/CT/6-134 - Framework Contract for CODAC Operation Application Engineering Support, inside the CCS environment (CODAC Core). Contract for 5 years, awarded to 2 different consortia, Task Orders assigned under restricted competence.

[F4E]: F4E-OFC-169 (PS-IC) Framework Service Contract for Provision of System and Instrumentation Engineering Support (2010-2011) in the field of Instrumentation and Control Systems engineering. On-going tasks are covering: Remote Handling, Buildings, Magnets (e.g. PFC), Cryogenic Plant, Tritium Plant, Test Blankets, Diagnostics, PCS, Heating Systems (i.e. NB Test Facility, ECH, ICH).

[CIEMAT] Exp. 241.286: Manufacturing and supply of the RF Subsystem for IFMIF-EVEDA LIPAc Accelerator Includes Supply, Installation, and Support of 16 RF Power Chains (i.e. 8 x 105kW & 8 x 200kW) at 175Mhz.

MARKETS

Nuclear / Defense / Automotive / Naval / Aeronautics / Space / Energy / Oil & gas / Public Administration / Bank

QUALITY CERTIFICATIONS, NUCLEAR QUALIFICATIONS

ISO 9001 / ISO 14001 / PECAL 2110, 2210 and 2310 UNE-EN 9100 and 9110 aerospace series / CMMi/ TMMi / UNE-ISO/IEC 27001 / UNE-ISO/IEC 20000-1 / EMAS



IFMIF-Prototype
RF Module



COMPANY NAME	INGECIBER
ADDRESS	C/ Vivero, 5, 3º2, 28040 Madrid. Spain.
WEB	www.ingeciber.com
TURNOVER	415,000 € in year 2021
EMPLOYEES	14 in year 2021
SME	YES
CONTACT PERSON	José Miguel Moreno
	POSITION CEO
	PHONE +34 91 386 2222
	EMAIL jm.moreno@ingeciber.com

COMPANY ACTIVITIES AND SKILLS

Ingeciber is an Engineering company founded in 1986 specialized in the Finite Element Method (FEM) and CAE Simulation tools. We develop Engineering Consultancy Services, training services, CAE Software Distribution and Technical Support in the Civil and Mechanical engineering industries.

Our Software Development and Consultancy Engineering Departments have over 35 years of experience in the CAE applied to Mechanical, Civil and CFD engineering including the FUSION and FISION Nuclear Power Sector. Additionally, we have the required knowledge to perform any structural and CFD simulation analysis using our own CAE software as CivilFEM for ANSYS and CivilFEM powered by Marc, and other CAE tools such as ANSYS SpaceClaim, CFD++, ParticleWorks and other applications.

Since Ingeciber was founded we have always been present in the most innovative engineering sectors. Our activities have been also to provide ITER/F4E and some NPP projects with the analysis, design and checking structures, devices and equipment using CAE consulting with FEM and CFD software. Ingeciber has been selected by Fusion for Energy for a Service Contract for the provision of Engineering Support in the field of Mechanical Analysis for the Vacuum Vessel.

LARGE SCIENTIFIC FACILITIES AND NATIONAL RESEARCH FACILITIES CONTRACTS

[COBRA-AVANZIA] Analysis of vibrations in bearing 3 of the U3 electric generator equipment at the Tula Power Plant (2022)

[ITER - NUCLEAR ANSALDO] Buildings B44, B45, B46 and B47 of the ITER TB13 (2021) Support consultancy with CivilFEM for ANSYS APDL models through modal-spectral analysis, check-design of Limit States by standard of metal and reinforced concrete structures.

[SMARTEC] Structural seismic qualification of communications racks (2020) Ethylene storage and regasification plant in Fos Sur Mer, France (STEF).

[COBRA-AVANZIA] Foundation design and support structure of the U3 steam turbine-electric generator: (2019), Tula Power Plant (Mexico).

[HANHIKIBI-1 NPP – FENNOVOIMA] DESIGN REVIEW OF THE SAFETY BUILDING (10UKD) FROM HANHIKIVI-1 NPP (2019).

[DUNKERQUE LNG - EMERSON] Seismic Analysis of a Jetty Analyzer Structure Layout. Dunkerque LNG Terminal Plant (2018).

[ITER – FERROVIAL AGROMAN] Finite Element Analysis of Vibration and Frequency Transmission from the Compresor Foundation Blocks into the Building B51. ITER Project TB03 (2018). The goal of this project was to offer a techno-economic study using the Finite Element Method, in order to analyze the vibrations generated by a group of compressors and its transmission through the soil to the B51 building under study.

[ENEL] MOCHOVCE SEISMIC RE-EVALUATION OF EMO 1&2 NPPs (2014)

[F4E] F4E-OMF-356 Framework service Contract for the “Provision of Engineering Support in the field of Mechanical analysis for the Vacuum Vessel”. Awarded (IO Portal) (2012)

[WESTINGHOUSE] Design and checking of structural elements of buildings of the Nuclear Plant type AP 1000” (2011).

[ENSA] Modeling and design features for the seismic analysis of the IRIS vessel, core barrel and internals” (2010).

R&D PROJECTS

NONLINEARFEM (2021-2022) R&D in advanced CAE Technologies to obtain a prototype with non-linear capabilities that can provide civil engineers with a closer approach to reality in the design and rehabilitation of civil infrastructure.

MININGFEM (2017-2019) R&D of Advanced Mathematical models and Technologies for optimum CAE Analysis and Design of Pits and Tunnel Mines

EUREKA (CAEDAMTEC) (2015-2016): R&D of advanced Technologies for CAE Analysis and Design of Large Dams under construction stages, non-linear environment behavior and earthquake loads.

AZIMUT (2010-2013): R&D to develop an off-shore wind turbine of 15 MW in 2020. Project coordinated by GAMESA and 11 companies and 22 Research Centers participated.

MARKETS

Nuclear / Automotive / Naval / Energy /Oil & gas / Construction

QUALITY CERTIFICATIONS, NUCLEAR QUALIFICATIONS

ASME / ISO 9001 / NRC USA

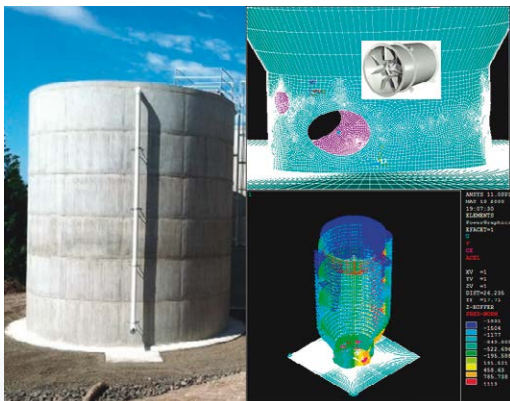

Reinforced concrete tank

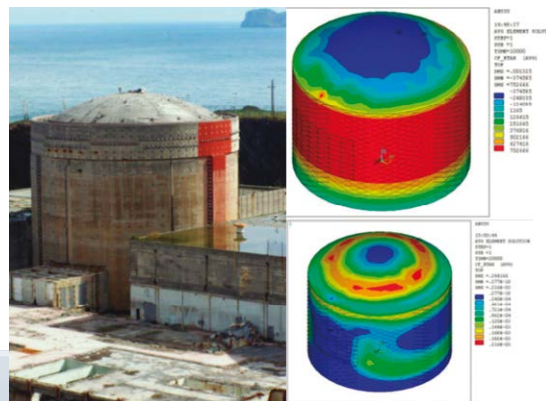

Reactor renewal inside an old prestressed NPP containment



COMPANY NAME	INSYTE Electronics, S.A.
ADDRESS	C/ Calidad, 6 PI Los Olivos, Getafe 28906 Spain
WEB	www.insyte-electronics.es
TURNOVER	8.2 MEuros in year 2021
EMPLOYEES	76 in year 2021
SME	YES
CONTACT PERSON	Raquel Rodríguez Quintero
	POSITION CEO
	PHONE +34916010991
	EMAIL rrodriguez@insyte.es

COMPANY ACTIVITIES AND SKILLS

Industrialization and assembly of electronic boards and complete electronic products for different applications, in harsh environment and considered safety critical for different sectors including scientific installations.

Assembly of harnesses for power applications, communications including fiber optics cables (multi and mono mode).

All fully inspected and tested. CoC and production documents

LARGE SCIENTIFIC FACILITIES AND NATIONAL RESEARCH FACILITIES CONTRACTS

[CERN] ELMB mother boards, Beam Energy Acquisition 3U (BEA/3U), Beam Energy Meter (BEM), Beam Energy Interlock (BEI), Beam Energy Controller (BEC), Beam Energy Acquisition 6U (BEA/6U), Beam Energy Acquisition 3U (BEA/3U), TPA EDA-03500-V1-1, ITS PU LEFT REV.2 17026-3L, ITS PU RIGHT REV.2 17026-3R, TARJ. EDA-03791-V2-0

[ILL] Carte MED32, M32MB, RDL DATA LVDS, TARJ. MCC V2, FFSD FLAT CABLE, MEZZA_NUM_MDR, Board COOLTOT

R&D PROJECTS

Device for measuring creatinine on the blood, Device for controlling different tools from a drone, device to help with rehabilitation to people with ictus, home interface for charger for electrical vehicles, device for people taken multiple medications, sensors for different applications (safety in people), communication boards of GHz, controlling board for micro valves, light for metro, stewardess call, AC supply for military vehicles, etc.

MARKETS

Nuclear / Defense / Automotive / Naval / Aeronautics / Space / Energy / Railway / medical

QUALITY CERTIFICATIONS, NUCLEAR QUALIFICATIONS

ASME / ISO 9001 / ISO 14001 / ISO9100 / ISO13485



Automatic varnish machine

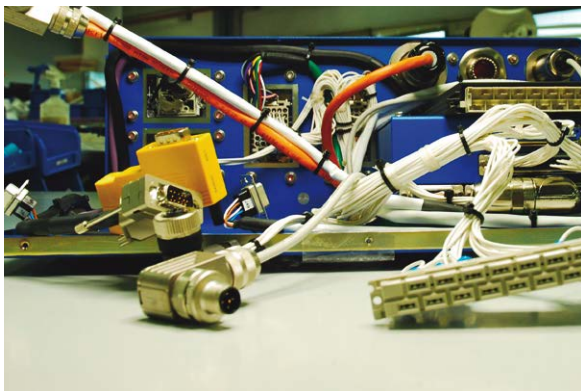

Internal cabling for racks and boxes



Complex and long cables for communications, fiber optics and power

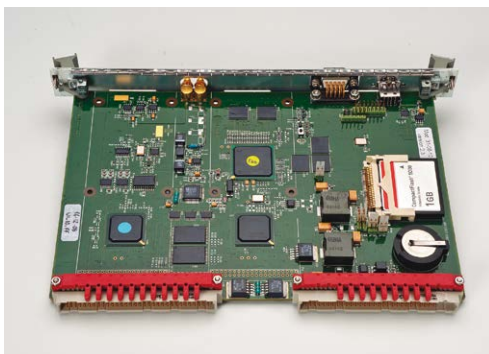

Complex assembly of boards.

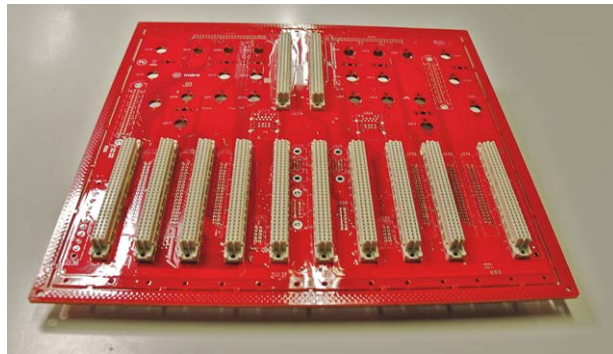

Press-fit technology



COMPANY NAME	INTARCON Industrias de Tecnologías Aplicadas en Refrigeración y Conservación, S.L.
ADDRESS	P.I. Los Santos, Bulevar de los Santos 34; P.Box 410; 14900 Lucena (Córdoba), España
WEB	www.intarcon.com
TURNOVER	25.6 M € in year 2021
EMPLOYEES	229 in year 2021
SME	YES
CONTACT PERSON	Eduardo López Sáez POSITION Chief Financial Officer
	PHONE +34 957 50 92 93
	EMAIL elopezsaez@intarcon.com

COMPANY ACTIVITIES AND SKILLS

INTARCON is a Spain-based company dedicated to designing, manufacturing, marketing and servicing a full range of refrigeration equipment for commercial and industrial sectors.

The mission at INTARCON is to develop and offer the markets a wide range of innovative solutions for the most reliable, efficient and sustainable operation of refrigeration facilities.

The human team of INTARCON has valuable experience of over 35 years in the fields of refrigerations, air conditioning and related thermal appliances, focusing thte effort on the conception and development of a wide range of innovative refrigeration solutions.

Presently, INTARCON has supplied more than 40 000 units and systems to more than 40 countries all over the world by mean of a sales and service network in more than 30 countries.

INTARCON is highly concerned about the environment and carries out many R&D projects conducted to develop environmentally friendly solutions based in energy saving and efficiency, with natural refrigerants.

LARGE SCIENTIFIC FACILITIES AND NATIONAL RESEARCH FACILITIES CONTRACTS

[ESO] Desing, manufacturing and testing of custom-made

-25°C glycol chillers for ESO Paranal site, in Atacama desert in humedity, to maintain accurate conditions for the electronic and optical equipment of VLTi auxiliary telescopes. (2013-2014-2015)

[CERN] Precision chiller (2013)

R&D PROJECTS

[CDTI] INDIRA – Research and development of an innovative product for industrial refrigeration with R-717 (NH3) (2019) Exp. IDI20191161

[CDTI] EJERCER – New refrigeration and air conditioning system based on ejector technology applied to high efficiency refrigeration cycles with natural refrigerants for commercial and industrial refrigeration (2018) Exp. ITC 20181143

[CDTI] Efficity – Development of efficient refrigeration cycles for ultra-light electrical urban transport and domestic applications with high performance air cooling and predictive maintenance solutions (2016) Exp. ITC 20161113

[CDTI] DESEHVAC – Design and development of air conditioning processing of air cooling with control of temperature and humidity by means of nanometric spray of desiccant liquids (2015) Exp. ITC 20151330

[CDTI] ECOMARKET - New refrigerant system with natural refrigerant for supermarket (2015) Exp. ITC 20151100

HUMIDEX Project – Coworkers as suppliers with committee company (2014)

[IDEA] Effimarket – Expansion of production capacity in manufacturing plant for industrial refrigeration equipment (2013)

[CDTI] AIRE – Variable capacity efficient air conditioning systems for electric buses (2013) Exp. ITC 20131012

[CDTI] Development of prototypes and series of a new generation (2008) Exp. IDI 20080962

MARKETS

Nuclear / Defense / Automotive / Naval / Aeronautics / Energy / Oil & gas

QUALITY CERTIFICATIONS, NUCLEAR QUALIFICATIONS

ISO 9001 / RoHS, CE, F-Gas

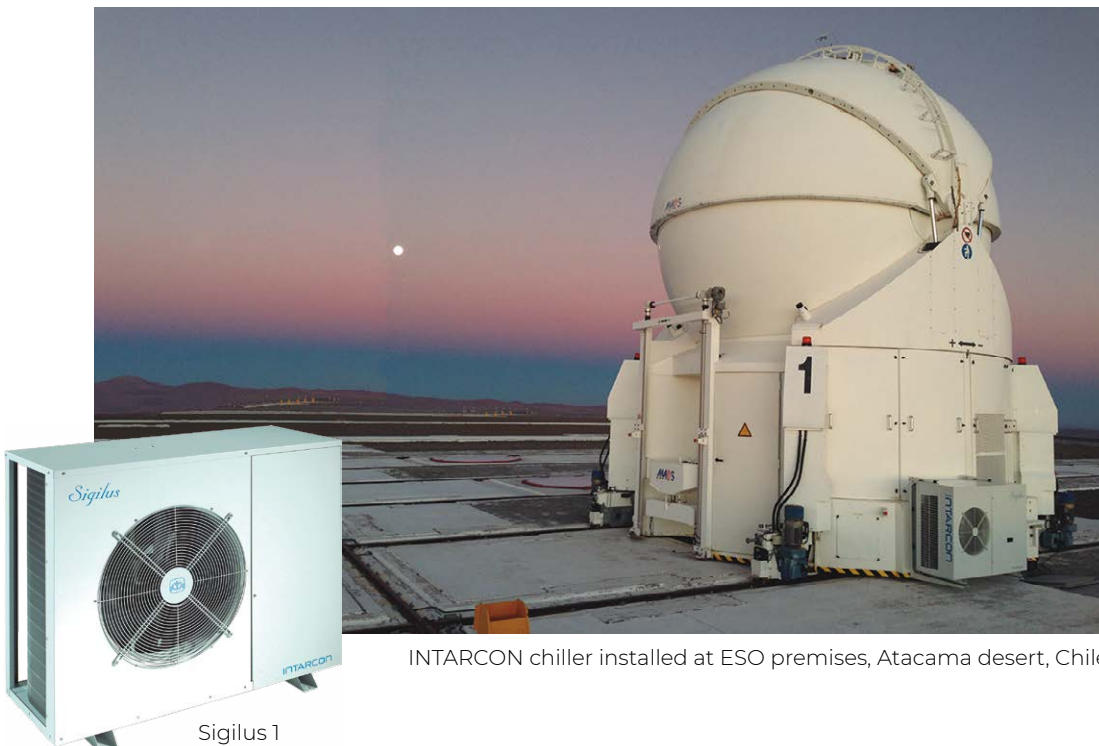

INTARCON chiller installed at ESO premises, Atacama desert, Chile

Sigilus1



COMPANY NAME	INTEGRASYS SA
ADDRESS	Calle José Echegaray 8, edificio 3, planta 1, oficina 3 - Las Rozas, 28232, Madrid
WEB	www.integrasys-space.com
TURNOVER	1,6 M € in year 2020
EMPLOYEES	20 in year 2021
SME	YES
CONTACT PERSON	Álvaro Sánchez García de Viedma
	POSITION CEO
	PHONE +34 91 631 68 46
	EMAIL info.sales@integrasys-sa.com

COMPANY ACTIVITIES AND SKILLS

Integrasys is a SME company founded in 1990. It is a software development and engineering company specialized in satellite network design, deployment, maintenance, and interference mitigation, making tools for monitoring critical satellite infrastructure in the commercial and defense fields. Integrasys offers a wide range of signal monitoring products and VSAT Deployment, maintenance, and link budget solutions for telcos, satellite service providers, satellite operators, and governments around the globe. Its main business is the design, development and manufacturing of Operations Support Systems (OSS) for network management, with a particular focus on satellite networks and spectrum level tools. Integrasys currently holds a leading position in the carrier monitoring systems market for the professional VSAT segment. Since 1993, Integrasys is participating in international R&D projects, individually or working in consortium with other partners. Currently, Integrasys has offices in Europe, America and Asia for an improved customer experience.

LARGE SCIENTIFIC FACILITIES AND NATIONAL RESEARCH FACILITIES CONTRACTS

Integrasys main capacities for ITER activities involve providing R&D and consultancy services in software-based monitoring and control systems. In this regard, our main skills are related to signal monitoring, network manager and managed applications over SNMP, middleware, RF & microwave automated test and measurement systems, development of software and technology based on open standards and for embedded systems. Therefore, our main interest in ITER is about CODAC related activities

R&D PROJECTS

[ESA] Ka-METROCAL: Ka-Band Metrology and Calibration System (2015-2016)

The project aims to design, manufacture and test a high precision (+/- 0.5 dB uncertainty) metrology and calibration system breadboard and application software for Ka Band able to perform fast, accurate and inexpensive Rx Carrier Power measurements for different satellite services in Ka-Band.

[H2020] RESISTO (2018-2021)

RESISTO (RESilience enhancement and risk control platform for communication infras-

structure Operators) project is about Prevention, detection, response and mitigation of the combination of physical and cyber threats to the critical infrastructure of Europe. RESISTO implements an innovative Decision Support System to protect communication infrastructures from combined cyber-physical threats exploiting the Software Defined Security model on a suite of state of the art cyber/physical security components and services for detection and reaction in presence of attacks or natural disasters. We participate in this project with some of the main actors in the telecom market, such as Telecom Italia, British Communications, Orange, Ericsson, etc.

[ESA] CLEANRF: RF BLIND INTERFERECE REMOVAL FOR SPACE LINKS (2020-2022)

The CLEANRF project addresses the development of a set of algorithms that allows the implementation of a system for the detection, separation and cancellation of interference, which is completely transparent to the transceiver that is to be protected. The final device is the most resilient interference cancellator system, which allows terrestrial interference detection and elimination efficiently. It has been developed for LEO, MEO & GEO constellations.

MARKETS

Defense / Aeronautics / Space / Oil & gas

QUALITY CERTIFICATIONS, NUCLEAR QUALIFICATIONS

CMM level 2 (software development)

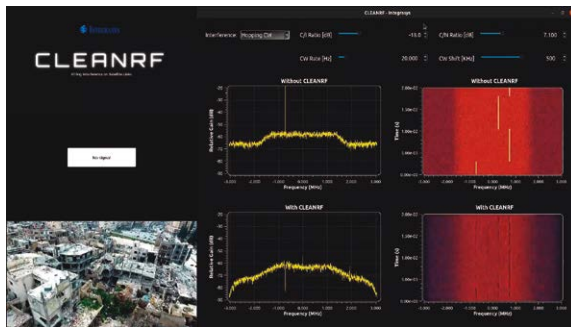

Interference Cancellation System - CleanRF



VSAT AutoCommissioning - Satmotio Pocket



Carrier Monitoring System - Controlsat

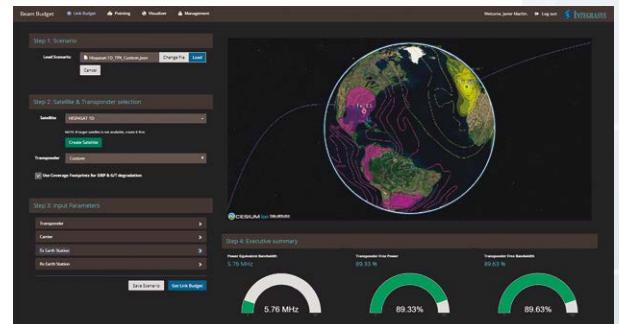

Link Budget Tool - Beam Budget



COMPANY NAME	ISDEFE Ingeniería de Sistemas para la Defensa de España S.A.,S.M.E.,M.P.
ADDRESS	C/ Beatriz de Bobadilla 3, 28040 Madrid
WEB	www.isdefe.es
TURNOVER	153,34M€ in year 2020
EMPLOYEES	1.622 in year 2020
SME	NO
CONTACT PERSON	Lluís Vinagre
	POSITION Director of the Business Strategy Department
	PHONE +34914115011
	EMAIL lvinagre@isdefe.es

COMPANY ACTIVITIES AND SKILLS

Consultancy

Technical Assistance

Engineering and Operations Services

Turn-Key Projects

LARGE SCIENTIFIC FACILITIES AND NATIONAL RESEARCH FACILITIES CONTRACTS

[ESA] ESAC Scientific Astronomy Operati3n and Development Support, several contracts from 2005 to date, 10 Engineers and Scientists.

[INTA-CSIC] Astrobiology Center. Assistance in scientific, divisive and engineering matters. 11 ISDEFE consultants through two assignments.

[ESA] Telemetry Tracking and Command, Ground segment operations for ESA science missions, 6 Engineers.

[INTA] Through different assignments, it provides assistance to INTA in the scientific-technical programs in which it participates. More than 250 ISDEFE consultants at INTA of which 45 participate in the management of INTA infrastructure and scientific programs in which the Institute participates.

[NASA] Support to Radio-astronomy Activities in Madrid Deep Space Communications Centre, MDSCC, 2000 to date.

R&D PROJECTS

[INTA-ESA] Cooperation in Education for Science and Astronomy Research CESAR, 2010 – to date.

MARKETS

Defense / Aeronautics / Space / Energy

QUALITY CERTIFICATIONS, NUCLEAR QUALIFICATIONS

ISO 9001 / ISO 14001

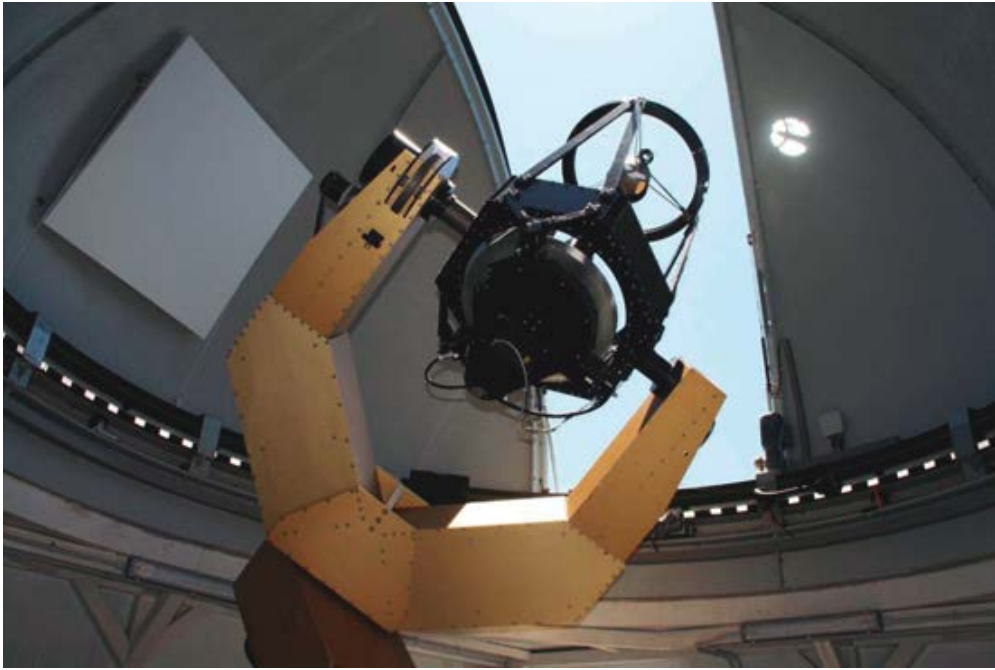

CESAR Project Telescope, ESA-Cebreros



TBT Telescope in the Satellite Tracking Station at Cebreros

COMPANY NAME	JEMA ENERGY SA
ADDRESS	Paseo del Circuito 10 20160 Lasarte-Oria (Gipuzkoa)
WEB	www.jemaenergy.com
TURNOVER	45 M€ in year 2020
EMPLOYEES	170 in year 2020
SME	NO
CONTACT PERSON	Leire Gonzalez
	POSITION Marketing and Communication
	PHONE +34 943 37 64 00
	EMAIL l.gonzalez@jemaenergy.com

COMPANY ACTIVITIES AND SKILLS

Jema Energy designs and manufactures customized power conversion systems.

The company is part of Irizar Group (3300 employees and yearly turnover over 700 M€).

Our scope includes a wide range of high current and high voltage power supplies for magnet coils, RF tubes and plasma heating systems used in a nuclear fusion installation and particle accelerators.

LARGE SCIENTIFIC FACILITIES AND NATIONAL RESEARCH FACILITIES CONTRACTS

Science – Particle Accelerators

[ESS Lund] 12 x HVPPS Klystron Modulators 115kVdc/100A, 14Hz (2017)

[RAL- ISIS] 4 x HVPS Tetrode 20kV/20A (400kW) (2016)

[IFIC- IFIMED] 2 x HVPPS Klystron 150kV/110A, 16,5MW peak, 5us pulse, 400Hz rep rate (2016)

[CIEMAT- IFMIF] 7 x HVPS Tetrode 11kV/34A (375kW); 4 x HVPS Tetrode 8kV/45A (360kW) (2015)

[ESS Bilbao] 2 x HVPPS Klystron 120kVdc/60A, 7.2MW peak, 9% duty cycle (2015)

[ESS Bilbao - SNS Oak Ridge] 1 x HVPPS Klystron 85kVdc/160A, 14MW peak, 9% duty cycle (2013)

[ESS Bilbao- ITUR] Power supplies for ion source; 110kVdc/120mA, 25kVdc/2A, 80Vdc/100A, 800Vdc/2A (2010)

[GSI - DESY-II] 1 x AC Dipole 1330V/1004A; 1 x DC Dipole 1560V/520A; 2 x Quadrupole 210V/650A; 3 x Sextupole 85V/200A, < 10ppm (2009)

Science – Fusion Energy

[CCFE- MAST upgrade] 1 x HVPPS for Positive Ion Neutral Injector (PINI) 80kVdc/70A, 5,6MW, 2% duty cycle (2018)

[Tokamak Energy- ST40] 1 x BvU PS 12kA ±500V, 1 x Central Solenoid PS + 17.1 kA -14.5kA

- 1Kv, 1 x Toroidal Field PS 100kA/100V 0,6s pulse (2017)
- [TAE- C2W] 2 x Electrode PSU 5kV/300A 50ms pulse (2017)
- [F4E- JT60SA] 1 x MHVPS 60kV/2x55A pulsed 100s, 2 x BPS 35kV, 100mA and 2 x APS 50kV/100mA (2018)
- [TAE- C2W] Pulsed magnet PS; 1100V/3600A cells can be combined up to 4 in series and parallel (max 63MW) 2016)
- [CCFE- MAST upgrade] Multi-megawatt IGBT brake chopper and a high-current crowbar (2015)
- [CEA Cadarache- JT60SA] 1 x Toroidal Field PS 1kVdc/±20kA, 20MW continuous; 4 x Equilibrium Field PS ±1 kVdc/±20 kA and ±1 kVdc/+10 kA,-20 kA, 12% duty cycle (2016)
- [ENEА- JT60SA] 4 x Central Solenoid + 2 x Equilibrium Field PS 1kV/±2*10kA, 12% duty cycle; 2 x Fast Plasma Positioning PS 2kV/±5kA, 7% duty cycle (2017)
- [CCFE- MAST upgrade] Toroidal Field Power Supply 340Vdc/133kA, 45MW, 0,3% duty cycle (2015)
- [IPR- ITER gyrotron test] 1 x Solid State HV Crowbar -70kV (2011)
- [CCFE- MAST upgrade] 1 x HVPPS for Positive Ion Neutral Injector (PINI) 80kVdc/70A, 5,6MW, 2% duty cycle (2010)
- [EFDA- JET] 4 x Seriable Power Supplies ±12kVdc/±5kA, 60MVA, 10% duty cycle for Enhanced Radial Field Amplifier (ERFA)] (2009)
- [CIEMAT – TJII] 1 x HVPPS for Electron-Cyclotron Resonant Heating (ECRH) gyrotron 80kVdc/50A, 0,1% duty cycle (2007)
- [EFDA- JET] 8 x LTT crowbars 130kV (2009)
- [IPP- Wendelstein 7-X] 10 x Control Coils Power Supplies ±30Vdc/±3Ka (2002)
- [EFDA- JET] 2 x HVPPS for Neutral Beam Enhancement (NBE) 130kVdc/130A, 16,9MW, 3% duty cycle and crowbars (2003)

MARKETS

Automotive / Energy / Oil & gas

**QUALITY
CERTIFICATIONS,
NUCLEAR
QUALIFICATIONS**

ISO 9001 / ISO 14001



JEMA facilities ESS-Bilbao Project



JEMA facilities R&D área



COMPANY NAME	LEADING METAL MECHANIC SOLUTIONS, S.L.
ADDRESS	Barrio La Agüera, s/n - 39409 - San Felices de Buelna (Cantabria)
WEB	www.leading.es
TURNOVER	22M € (2021)
EMPLOYEES	142
SME	YES
CONTACT PERSON	Marcos Pérez
	POSITION Business Development Director
	PHONE (+34) 610 261 493
	EMAIL mperez@leading.es

COMPANY ACTIVITIES AND SKILLS

OVERVIEW: LEADING is a horizontal mechanical and mechatronic solutions company with 50 years of experience in strategic sectors from engineering to advanced manufacturing techniques, such as precision machining, mechano-welding, complex unions (laser, orbital, HIP, brazing, beryllium, coatings, thermal treatments, assembly of mechatronics, NDT and DT examination among other services.

FUSION CAPACITIES: Mechanical Engineering: mechanical design (2D/3D) and engineering simulations, Components manufacturing (prototype/series) and integration of turn-key systems., Beryllium workshop, one of the most advanced in the world. Beryllium is one of the science-preferred materials for its high-performance applications.

LARGE SCIENTIFIC FACILITIES AND NATIONAL RESEARCH FACILITIES CONTRACTS

[ESS] - Design of manufacturing plan and manufacturing of Proton Beam Window (PBW) – Ref. 035/20

[NRG] - Beryllium Reflector Elements for the HFR Petten – Ref. 2020-271

[F4E] (FUSION BUSINESS LEADERSHIP) - Series Manufacturing of the FW panels – Ref. F4E-OPE-0900-03

[F4E] – Manufacturing of Welded Support Mock-Ups – Ref. F4E-OPE-1060 (2019)

[ITER] (DYNAMIC) Tokamak Assembly Contract no.2 (TAC-2) – Ref. 10/19/CT/4300001900 (2019)

[STFC] – TS1 Project Beryllium Reflector – Ref. UK SBS PR17134 (2018)

[F4E] – Manufacturing of Prototypes of the Supports of the Blanket Cooling Manifold (BCM) System and Application of Coatings on Different Items – Ref. F4E-OPE-0833 (2018)

[ITER] – AMW (Ansaldo Nucleare & S.p.A, Mangiarotti S.p.A) – Sub-assemblies for ITER Vacuum Vessel (2017)

[F4E] – Splice Plate Custom Machining for JT-60SA TF-Magnet – Ref. F4E-OPE-0805 (2016)

[ESS] – Fabrication of ESS Target Cassettes – Ref. 162/16 (2016)

[F4E] – Supply of Full-Scale Prototypes of the ITER Normal Heat Flux (NHF) First Wall (FW) Panels – Ref. F4E-OPE-443-03 (IV-PT) (2014)

[F4E] – Fabrication of a Standard Semi-Prototype of the ITER Normal Heat Flux (NHF) First Wall (FW) Panels – Ref. F4E-OPE-394 (IV-PT) (2012)

R&D PROJECTS

MISIONES CDTI 2021 -Empresarios Agrupados- MIG-20211066: Industrial research in technologies and processes applied to IFMIF-DONES to evolve in the fusion program

MISIONES CDTI 2020 -Empresarios Agrupados- MIG-20201051: Research on new materials, technologies, and advanced processes to contribute nuclear fusion

PID CDTI - ALT_GICs (IDI-20200189): Research high added value metal-mechanic components for supply to large scientific facilities

PID CDTI - ESS TARGET (IDI-20160181): Industrial research focused on the development of metallic components for European Spallation Source Target (ESS)

PID CDTI – FUSION TECHNOLOGIES (IDI-20151082): Advanced manufacturing technology for Science Industry. Application in the field of fusion.

MARKETS

Nuclear / Defense / Automotive / Aeronautics / Space / Energy / Oil & gas

QUALITY CERTIFICATIONS, NUCLEAR QUALIFICATIONS

ASME / RCC-MR / ISO 9001 / ISO 14001 / ISO 45001



F4E-OPE-443-03_FSP FWP_ Back_LEADING



F4E-OPE-443-03_FSP FWP_Front_ LEADING

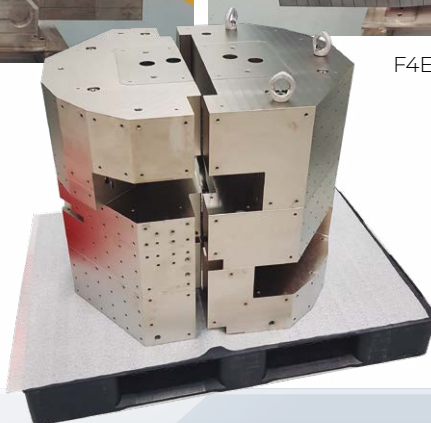

TS1 Project Beryllium Reflector_LEADING

LIDAX

COMPANY NAME	LIDAX
ADDRESS	C/ Antonio Alonso Martín, 1 28860 Paracuellos de Jarama (Madrid / SPAIN)
WEB	www.lidax.com
TURNOVER	2.2M€ in year 2021
EMPLOYEES	16 in year 2021
SME	YES
CONTACT PERSON	Jesús Aivar Mateo
	POSITION Sales & Innovation Manager
	PHONE +34 91 678 08 05
	EMAIL comercial@lidax.com

COMPANY ACTIVITIES AND SKILLS

LIDAX is a technology company founded in 2000. LIDAX develops high advanced Optical & Opto-electronics units used as part of Space or On-ground instrumentation, from design through to the delivery of integrated and tested equipment.

Our Optical Units are essential in Optical and IR Instruments which operates from IR, VIS up to UV wavelength and may include precise passive/active thermal control elements and, if necessary, high accuracy positioning mechanisms.

LIDAX's infrastructure and internal processes are implemented to carry out a serial production of space products (industrialization).

LIDAX's space product family includes: Focal Planes Assembly and Optical Units for Spectrometers / Cameras, Telescope Optics & Mounts, LIDARs for Space Applications (e.g. In Orbit Servicing), Cryogenic Folding Mirrors, Optical Head / Lens Objective

In a fully integrated and equipped centre of 1.800m², LIDAX concentrates the development office for design and engineering activities, the assembly, integration / clean room areas (ISO5 & ISO 7), the thermal testing laboratory (e.g., Bake-Out Chamber, Cryostat) & metrology equipment (e.g. CMM, Interferometer / Autocollimator)

LARGE SCIENTIFIC FACILITIES AND NATIONAL RESEARCH FACILITIES CONTRACTS

[ESA] PLATO Payload Focal Plane Assembly (FPA) Thermo-mechanical elements QM and FMs (2022-2023)

[ESA] PLATO Payload Focal Plane Assembly (FPA) CDR and Qualification model procurement (2021)

[ESA] Imaging LIDAR for Space Applications (2021-2022)

[IAC] Laser Launch Telescope for a Laser Guide Star (2020-2022)

[ESA/INTA] Development of EXOMARS RAMAN Instrument: iOptical Head Thermo-Mechanics Laser encapsulation box & Autofocus Mechanism (2014-2019)

[ESA/THALES] Development of FCI& IRS Telescope Optics for MTG Satellites Series. Optical Mounts and Environmental Test Campaign 24 Units delivered (2013-2020)

[ESA/AIRBUS D&S] Development of Co-alignment Sensor ATLID Earthcare Satellite. Thermo-mechanics (2012-2017)

[ESA] Cryogenic Testing Campaign of EChO Fine Steering Tip/Tilt Mechanism (2013-2014)

[ESA/TASE] Development of a Coarse Lateral Sensor PROBA 3. Thermo-Mechanics, 2009

[IAC] Atmosphere and Telescope Simulator for new adaptative optics, 2009.

[ESA/INTA] Focal Plane Assembly for BEPICOLOMBO Satellite MIXS-T & MIXS-C. Thermo-Mechanics, (2007-2015).

[ESA/INTA] Focal Plane Assembly for PLATO Cameras. Thermo-mechanics (2008-2020)

[ESA/INTA] James Webb Space Telescope Mid-IR Instrument Simulator (MTS). 4 Cryogenic Folding Mirror (2008-2009).

[IAC] Elmer Folding Mirrors for the Gran Telescopio Canarias (2005).

R&D PROJECTS

[Misiones CDTI TASE] MORERA System for the Monitoring of Efficient Irrigation and Agricultural Yield – TIR Objective Structure and MAIT (2021-2024)

[LIST] Feasibility Study of a Mass Spectrometer on board of a Scientific Mission (2019)

[INTA] High Conductance Thermal Management Components for the ATHENA IFU Instrument (2019)

[ESA] Development of Cryogenic Heat Switches 30-80K for Focal Planes Assembly and Cryocoolers in EO/Scientific Instruments. (2015)

[UE/REA] Development of a Deployer Mechanism & Carrousel for an Ultrasonic Planetary Core Drill for Space Robotic Exploration (2014).

[ESA] Development of a Family of Space Planetary Gearboxes (Dry Lubricated) (2012).

MARKETS

Aeronautics / Space / Astronomy On Ground, ITER

QUALITY CERTIFICATIONS, NUCLEAR QUALIFICATIONS

ISO 9001 / EN9100



PLATO ESA
Spacecraft
OHB System

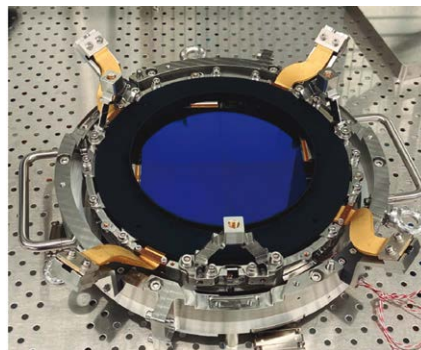

PLATO Focal Plane Assembly CAB_
INTA_LIDAX EM1

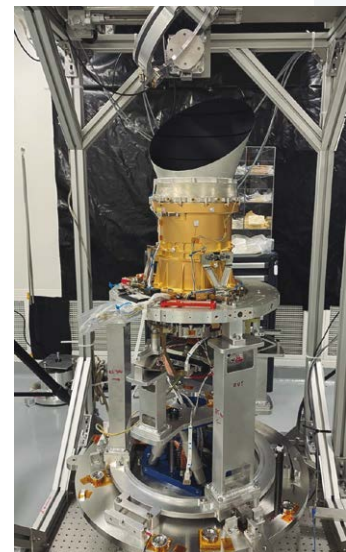

PLATO FPA_TOU_Alignment_
Set_up_ KU Leuven CSL_EM1

COMPANY NAME	MAMMOET IBERICA, S.A.U.
ADDRESS	P.I. Los Frailes, Crtra Alcala de Henares a Daganzo. Daganzo de Arriba 28814 Madrid
WEB	www.mammoet.com
TURNOVER	23.837.567 in year 2020
EMPLOYEES	140 in year 2021
SME	NO
CONTACT PERSON	Enrique Blasco
	POSITION Sales Manager
	PHONE +345 616 916 582
	EMAIL enrique.blasco@mammoet.com

COMPANY ACTIVITIES AND SKILLS

Mammoet is one of the world's major international heavy transport and installation contractors with a global network of operating centres and a large fleet of heavy cranes, specialist transport and installation equipment. As a complete solution provider for lifting, transporting, installing, ballasting, jacking and weighing large, heavy loads, organizations all over the world turn to us to push the boundaries of what's possible with their high-profile projects. Investment in technology, systems and equipment ensures we stay ahead: for example, our dedicated R&D facility is responsible for the Innovation Series, including equipment such as the AL.SK crane fleet and the Mega Jack system.

By investing as much in our people as we do in equipment, we have a world-class Combining exceptional project management with engineering intelligence, Mammoet offers worldwide heavy transportation and liftingservices to all industry sectors. The company was founded in 1983

and has expanded steadily through a balanced strategy of organic growth and acquiring key companies whose experience enhances our specialist capabilities. management structure to support our technical potential. So as well as having the best project managers and engineers available today, we'll have the best tomorrow, too.

By achieving maximum value from our next-generation equipment, we can effectively meet your requirements, building long-term strategic partnerships for an ever improving service.

LARGE SCIENTIFIC FACILITIES AND NATIONAL RESEARCH FACILITIES CONTRACTS

[ITER – DAHER] Movements: PF2 and PF5 coils from PF Building to Temporary Storage, PF6 from PF Building to Temporary Storage and later to Assembly Hall (2020)

[ITER – ALSYOM] Lifting and handling operations PF coils with TA6 gantry (2020)

[Ascó Nuclear Power Station in Spain – ENWESA] Heat exchangers replacement (2020)

[Vandellós II N.P.P. in Spain – AREVA] Handling spent fuel storage racks (2020)

[Almaraz N.P.P. in Spain – CNAT] Transport spent fuel storage flask JFK6 from ATI to fuel building U2 and back (2020)

[Azito 4 power plant in Abidjan (Ivory Coast)- COBRA] Azito Energie Transport and installation of main components (2021)

[Vandellós NPP in Spain - ANAV] Transport and storage of the main reactor head (2015)

[ITER - F4E] Lifting gantry for the lifting of main coils (2015)

[SIEMENS Egypt] Transport and installation of main components as turbine and generators in 2 power plants of total 4800 MW (2015)

R&D PROJECTS

-Lifting offshore wind prototype in Canaries

- Design and supply special low bed for the transportation of spent fuel storage flask from fuel building to storage area and route test / Almaraz Nuclear Power Plant (Spain) – CNAT (2017)

MARKETS

Nuclear /Naval / Energy / Oil & gas/ CIVIL - OFFSHORE-RENEWABLES

QUALITY CERTIFICATIONS, NUCLEAR QUALIFICATIONS

ISO 14001 / OSHAS 45001



Gantry crane PF coil



Lifting PF5



Transport and load out of 5 Slug catchers of 2000 tons in Gijón



Lifting gantry for the main coils in the ITER project



Mecánicas Bolea, S.A.

COMPANY NAME	MECÁNICAS BOLEA S.A.
ADDRESS	Avda. Bruselas, S/N (P.i. Cabezo Beaza) 30353 Cartagena – Murcia (España) www.mecanicasbolea.com
WEB	www.mecanicasbolea.com
TURNOVER	18.353.825,27 € in year 2021
EMPLOYEES	230 in year 2022
SME	YES
CONTACT PERSON	Eladio Valcárcel Sánchez POSITION Managing Director PHONE +34 968 324 220 EMAIL evalcarcel@grbolea.com

COMPANY ACTIVITIES AND SKILLS

Mecánicas Bolea has four main activities:

- Industrial Maintenance

Maintenance is one of the most experienced Division of Bolea Group. Our major clients belong to the industrial, chemical & petrochemical, and shipbuilding sectors.

We have available all the necessary resources and equipments to provide to our clients any service and technical solution that they may require, such as heat exchangers, gearboxes, pumps and valves repairs, milling machine works, welding jobs, laser alignments, onsite plants maintenance, etc.

- Aeronautics

In 1998, Mecanicas Bolea began its career in the aeronautic sector, as a supplier of large welded structures for the aircraft jigs & tools and industrial equipment.

In 2012, the Aeronautic Division was created, integrating the design of aircraft tooling with the supply of goods and equipment, thus providing a holistic response to our client's needs, i.e. from concept development to the final onsite installation of jigs & tooling equipment.

Nowadays, Mecanicas Bolea is classified as Tier 2 AIRBUS supplier for the direct provision of specific components and aircraft related tooling.

- Oil & Gas

With over 30 years of experience in the supply of goods and industrial units, Mecanicas Bolea is a solid provider of services in Oil & Gas. We encompass most of the stages within a project: from the initial design and implementation of manufacturing processes to the assembly and onsite commissioning.

Our range of products and services include reactors, tanks, furnaces, skids, complete vacuum units, distillation, evaporation, heat transfer, heat exchangers, air coolers and a wide range of pressure vessels that are calculated, modeled and executed according to international design codes in our workshops and offices.

In addition, we are present in the different petrochemical plants that we support, with the

capability to carry out construction, assembly and piping installation, industrial units, and fuel storage tanks, as well as the delivery of turnkey projects.

- Food & Pharma

Our food and pharmaceutical division provides a broad range of services and equipment to the different national and international clients. We can carry out complete complex projects applicable for different processes, oriented to fulfil our client's needs and most demanding requirements.

From the manufacturing of small containers of sanitary finish up to the supply of tailored machinery and production plants turnkey projects. Within our most distinctive products, we wish to highlight our autoclaves for pharmaceutical use, horizontal mixers for foodstuff, and plants for preserve concentration.

LARGE SCIENTIFIC FACILITIES AND NATIONAL RESEARCH FACILITIES CONTRACTS

[ESO] 97671/ESO/21/106447/ADE. ELT M2&M3 HANDLING TOOL (2021-2022)

[ILL] N°3415632/1 BOBINE FRESNELL (2021-2022)

[IAC-CTA] LIC-20-025 Azimutal Locking System LST2-LST3-LST4.(2020-2022)

[IAC-CTA] LIC-20-020 Access Systems at the Telescope Mount (2020-2022)

[IAC-CTA] LIC-20-017 Camera Access Towers (2020-2022)

[IAC-GTC]. GLIC19-004 Half Moon Platform Gran Telescopio de Canarias (2019-2020)

[ILL] D16 Detector Pressure Vessel Machining (2019-2020)

[IAC-CTA]. LIC-19-005 Azimut structures for LST-2, LST-3,LST-4 (2019-2020-2021) of the Cherenkov Telescope Array

[IAC-CTA] LIC-18-023 Azimutal Locking System LST1 of the Cherenkov Telescope Array (2019)

[CERN] Alignment tables for TANB (2018)

MARKETS

Defense / Naval / Aeronautics / Space / Energy / Oil & gas

QUALITY CERTIFICATIONS, NUCLEAR QUALIFICATIONS

ASME / ISO 9001 / ISO 14001

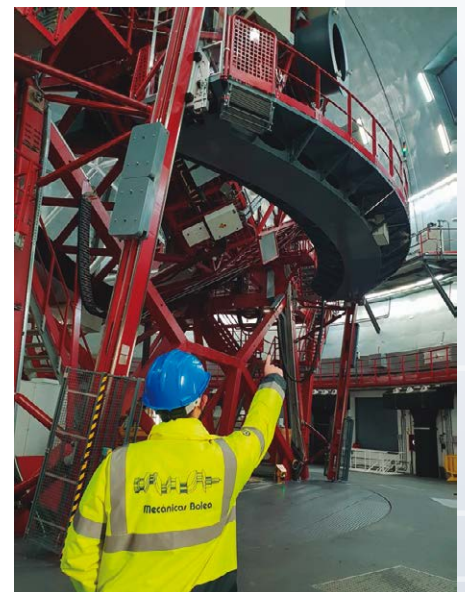

Grantecan Maintenance Platform

COMPANY NAME	MECANITZATS PRIVAT S.L
ADDRESS	POL. IND. PONT-XETMAR F-21. 17844 Cornellà del Terri
WEB	www.mecprivat.com
TURNOVER	3,5 M€ in year 2021
EMPLOYEES	42 in year 2021
SME	YES
CONTACT PERSON	Lluís PRIVAT
	POSITION CEO
	PHONE +34 972 594 602
	EMAIL lluis.privat@mecprivat.com

COMPANY ACTIVITIES AND SKILLS

PRIVAT was created in 1988, specialized in precision CNC machining and mechatronics integrated assemblies for a wide variety of industries and applications. Our production is based on all kinds of operations, including complex processes developed with high precision equipment. Our closed collaboration with qualified suppliers allows us to perform a wide range of treatments and mechanical specialisations to provide numerous solutions to customers.

We have 2 work centres for this purpose differentiating the machining plant and assembly plant, with a total surface of 3.000m² available.

The main activities are focused on the following markets:

- Engineering and industry
- Aerospace and defence
- Medical, pharmaceutical, and optics
- Robotics
- Scientific Instrumentation

LARGE SCIENTIFIC FACILITIES AND NATIONAL RESEARCH FACILITIES CONTRACTS

[ESO] - Frame Contract No. BO01196/ESO/20/100553/ADIN for Machining of Standard Mechanical Parts (2021-2023)

[ESO-SENER] – Manufacturing mechanical parts M2-M3-M5 for ELT (2020-2022)

[ESA-SENER] – Manufacturing mechanical parts JANUS JUICE Mission (2019)

[ILL] – Manufacturing mechanical parts of XtremeD Detector Modules (2018-2019)

[ESA-SENER] – Manufacturing mechanical parts for FIXBOX Mission (2015)

[ALBA SYNCHOTRON] – Manufacturing mechanical parts for several Beam Lines (2010-2017)

R&D PROJECTS

EURECAT - COMRDI16-1-0019. AVINT. Research Project for machining characterization.

MARKETS

Defense / Automotive / Aeronautics / Space / Energy / Oil & gas / Medical, pharma, optical and scientific Instrumentation

QUALITY CERTIFICATIONS, NUCLEAR QUALIFICATIONS

ISO 9001



Machining Plant

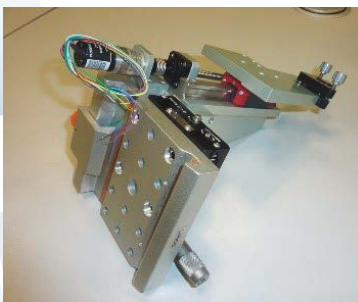

Mechatronics Assembly



Quality Department



Assembly plant



COMPANY NAME	METROMECAÁNICA SL
ADDRESS	Polígono Malpica calle E 32-39, Nave 43, 50016, Zaragoza
WEB	www.metromecanica.com
TURNOVER	4M€ in year 2021
EMPLOYEES	45 in year 2021
SME	YES
CONTACT PERSON	Fernando Comín
	POSITION CEO Metromecánica
	PHONE +34 639 201 666
	EMAIL fcomin@metromecanica.com

COMPANY ACTIVITIES AND SKILLS

Metromecánica was founded in 2003, more than 18 years of experience endorse it as a reference company in the provision of services and integration of industrial metrology solutions. Metromecánica works internationally providing 3D metrology solutions and developing turnkey projects that require the integration, automation, programming and installation of industrial metrology solutions.

Currently, Metromecánica has direct implementation in Spain in Getafe (Madrid), Zaragoza, Berriz (Vizcaya) and in France in Toulouse, St. Nazaire and Cadarache.

Thanks to the experience, the knowledge acquired in various sectors, the know-how accumulated by our staff and the mastery of the latest technologies in 3D metrology, Metromecánica develops research and innovation projects providing solutions that optimize measurement processes.

Metromecánica has quality certifications according to ISO 9001, EN9100 and NADCAP standards, a management system applied to processes and whose purpose is to meet all the requirements and expectations of its customers.

In addition, Metromecánica has the seal of innovative SME, a recognition with which the Ministry of Science and Innovation distinguishes small and medium-sized companies that have a highly innovative character.

The Quality and Environment model adopted by the company leads to permanent continuous improvement, where customer orientation and continuous training of Metromecánica's human team, in addition to its commitment to the Environment, are the two main axes in this improvement process, thus increasing the effectiveness and efficiency of its services.

Activities: Automations (high range metrology, metrology in online processes), Metrology services (Dimensional control projects, studies, simulations, measurement of complex installations, Measurement of products and assemblies, Reverse engineering), Digitized AEC - Architecture, engineering and construction (Large volume scanning, Digital Twin, applications in BIM and Smart Factory Product)

Products: Robotic solution with scanner sensor: Agile 3D, Gapgun PRO2 and Vectro profiler, Spatial Analyzer metrology software

LARGE SCIENTIFIC FACILITIES AND NATIONAL RESEARCH FACILITIES CONTRACTS

[CIEMAT]- Technical support in definition of monument networks for alignment (2022)

[ESO]- Optical Alignment Strategy (2018)

[F4E]- Supply of metrology instrumentation (2018-present)

[ITER]- Alignment & Metrology (2015-present)

R&D PROJECTS

Misiones Ciencia e Innovación- “Optimus” (Years 2021-2022-2023)

ITER- “Alignment & Metrology” (Year 2019)

ITER- “Alignment & Metrology” (Year 2015)

DICON-Desarrollo de nuevos sistemas avanzados de control dimensional en procesos de fabricación de sectores de alto impacto. (IPT-2011-1191-020000) (Years: 2011-2012-2013-2014)

SINIDE-Sistema inteligente de acabado de piezas y utillajes mediante sistema de pulido y desbarbado IPT-020000-2010-034 (Years: 2010-2011-2012-2013)

MARKETS

Nuclear / Defense / Automotive / Naval / Aeronautics / Space / Energy

QUALITY CERTIFICATIONS, NUCLEAR QUALIFICATIONS

ISO 9001 / ISO 9100, NADCAP



Automatic application for ITER project



Measurement in ITER facilities



COMPANY NAME	MONCOBRA SA
ADDRESS	Calle Cardenal Marcelo Spinola 10, 28106 Madrid
WEB	www.grupocobra.com
TURNOVER	150.000.000 € in year 2021
EMPLOYEES	1650 in year 2021
SME	NO
CONTACT PERSON	Ausias Pellicer Frasquet
	POSITION Business Development Manager
	PHONE +34 682 054 429
	EMAIL apellicer@grupocobra.com

COMPANY ACTIVITIES AND SKILLS

MONCOBRA is a service company specialized in site installation activities. Our core businesses are: Piping fabrication and erection, steel structure fabrication and erection and mechanical erection in general. We have more than 40 years of experience in the field, and we are used to work in high-requirement applications, such as Nuclear, vacuum, etc.

MONCOBRA is a Spanish company with international experience in Europe, Central and Latin-americas.

LARGE SCIENTIFIC FACILITIES AND NATIONAL RESEARCH FACILITIES CONTRACTS

[ITER ORGANIZATION] TCC2 Contract. Electromechanical and piping fabrication and erection in Tokamak Complex (2021-2026)

[CIEMAT – ENRESA] Dismantling and decontamination works in the frame of PIMIC Project. (2006-2009)

[CIEMAT – ENRESA] Rehabilitation of Building 55 (2005-2007)

[INSTITUTO ASTROFISICA DE CANARIAS] – Installation and testing of the steel dome of GRANTECAN (2007)

MARKETS

Nuclear / Automotive / Naval / Energy / Oil & gas / Steel and metallurgics / Food and Pharma

QUALITY CERTIFICATIONS, NUCLEAR QUALIFICATIONS

ASME / ISO 9001 / ISO 14001 / UNE 73401:1995 Quality Warranty in Nuclear Installations



GRANTECAN dome erection



Busbar installation at ITER



Nuclear Dismantling works



Nuclear Decontamination at CIEMAT

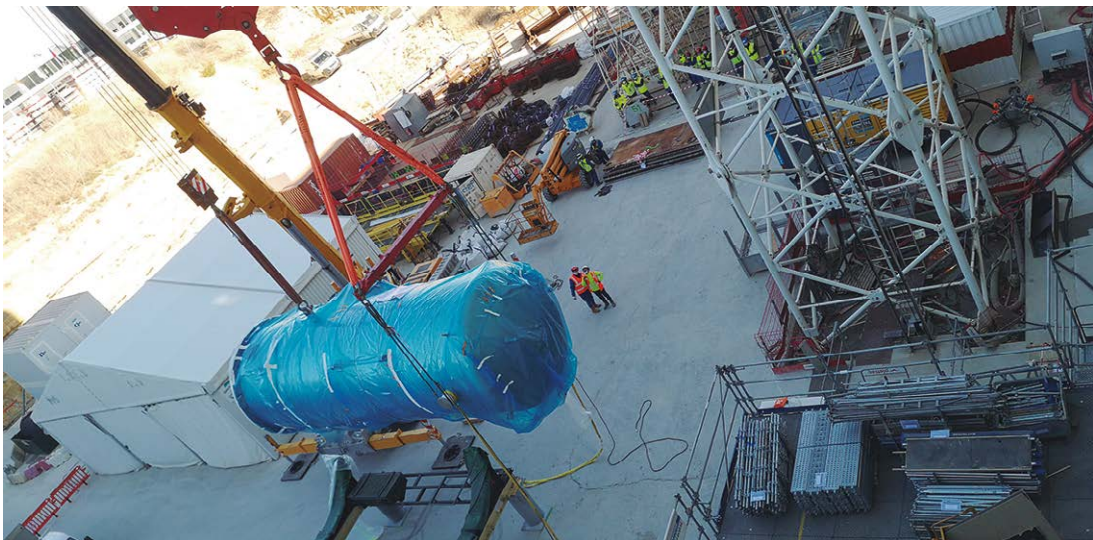

Vessel Installation at ITER



Nadetech Innovations

COMPANY NAME	NADETECH INNOVATIONS S.L.
ADDRESS	Polígono Arbide II, Calle V, Nave 4 - 31110 Noáin, Navarra, Spain
WEB	www.nadetech.com
TURNOVER	700k€ in year 2021
EMPLOYEES	12 in year 2021
SME	YES
CONTACT PERSON	Juan Antonio Ruiz Fuentes
	POSITION CEO
	PHONE 653370725
	EMAIL juanan.ruiz@nadetech.com

COMPANY ACTIVITIES AND SKILLS

Nadetech designs and produces machinery based on coating techniques (ultrasonic and precision spray, dip coating, electrospinning, sputtering), and others specially focused on tissue engineering and 3D printing.

We customize the solutions and offer tests to ensure the results. Our projects and customers are distributed in multiple sectors: biomedicine, chemistry, nanoscience, crystals, pharma, energy ... We also have experience in R&D, internally as well as for customers.

Our vision is to facilitate the knowledge transfer between Science and Industry, fostering the arrival to the society of advantages coming from new materials' development.

Since our creation, we have been cooperating with scientists and industry professionals, delivering proper tools for their specific environments. Communication is crucial to succeed in this task, following the compromise of offering solutions able to deliver the maximum potential of materials.

Improving people's lives through advanced materials science applications.

LARGE SCIENTIFIC FACILITIES AND NATIONAL RESEARCH FACILITIES CONTRACTS

[Universidad de Córdoba] CN2020-009183 (2020)

Supply and installation of ultrasonic spray pyrolysis equipment corresponding to the SOMM17-6116 project of the 2017 call of the Ministry of Economy and Knowledge of the Government of Andalucía for Grants for the Strengthening of University and Research Institutes in Andalucía, Centers and Infrastructures for the acquisition of the "Severo Ochoa" or "María Maeztu" stamp within the scope of the Research, Development and Innovation Plan (PAIDI 2020), co-financed by the European Regional Development Fund (ERDF).

[Universidad Politécnica de Valencia] CD2019-723220 (2019)

Acquisition of Spray Coating Equipment ("SPRAY COATER").

[Instituto de Tecnología Química] DOC_1576166520006 (2019)

Supply and installation of equipment for the comprehensive production of nano-structured

materials and functionalized ceramic components. Co-financed FEDER funds EQC2018-004595-P, destined for the Institute of Chemical Technology.

MARKETS

Automotive / Energy / Health, Bio, Science...

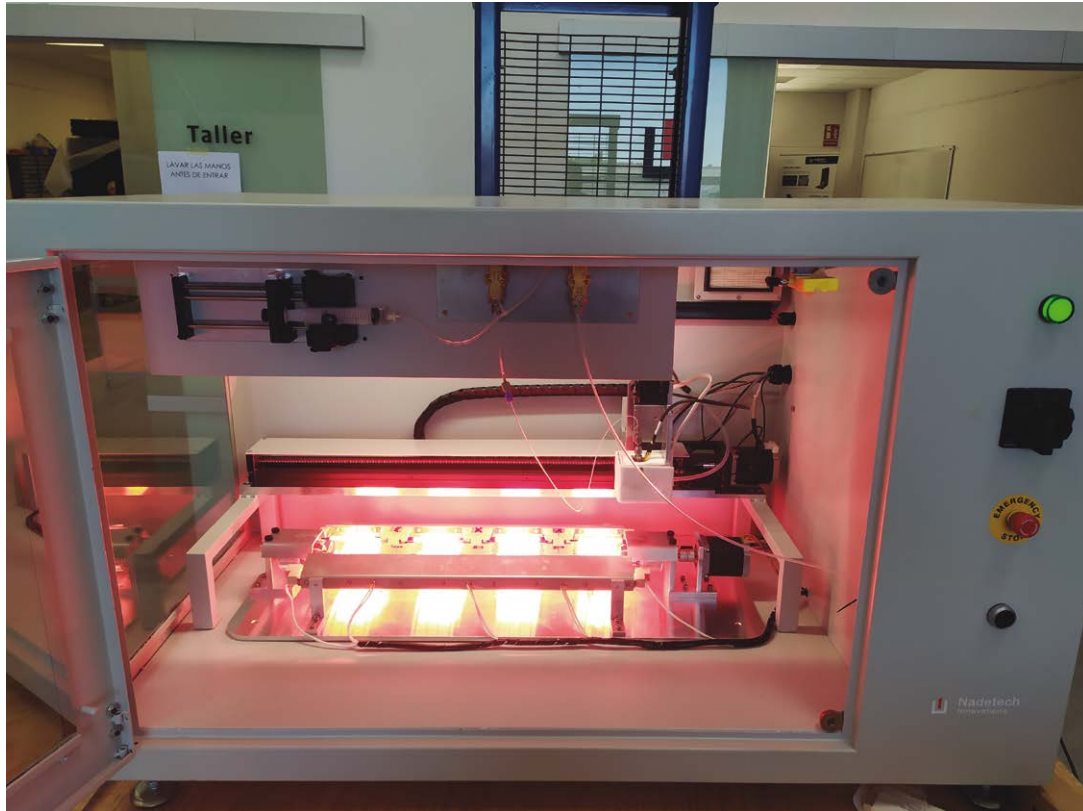

Customized ultrasonic spray for coating tubes

COMPANY NAME	NANOKER RESEARCH SL
ADDRESS	Polígono Industrial de Olloniego, Parcela 22-A, Naves 5-7, 33660, Oviedo, Principado de Asturias, Spain
WEB	www.nanoker.com
TURNOVER	1,78 M€ in year 2020
EMPLOYEES	24 in year 2020
SME	YES
CONTACT PERSON	Samuel Menéndez
	POSITION Managing Director
	PHONE +34 610 223 437
	EMAIL s.menendez@nanoker.com

COMPANY ACTIVITIES AND SKILLS

The company has expertise in the development of special materials (ceramics, ceramic-composites) for extreme environments and in the manufacturing of top-end products based on them. The company has skills in the synthesis and conditioning of new materials, starting from precursors and on the shaping and densification of these materials into final parts. The shaping processes, available in the company, are slip casting, pressure casting, cold isostatic pressing and green machining. The densification processes, available in the company, are conventional sintering and pressure-assisted sintering (spark plasma sintering and hot-pressing)

The company has a solid background in the development and consolidation of oxidic ceramic materials (Zirconium oxide, aluminum oxide and its composites) and non-oxidic ceramics (machinable aluminum nitride, boron nitride composites, graphite-metal carbide composites, refractory metals - Mo, W, Cermets - TiC, TiN, and custom-made sputtering targets).

Nanoker supplies its products to different market sectors: big science, automotive, oil and gas, jewelry, metal forming, chemical and thin-film industry.

TECHNOLOGIES AND CAPABILITIES

- Spark plasma sintering: Pressure assisted sintering technology to produce special materials (i.e. graphite-molybdenum material for collimators) and to join dissimilar materials (i.e. refractory metals to ceramics).
- Cold isostatic pressing: To produce green bodies to be processed in further steps into final shape.
- Green Machining: Precision shaping to green bodies by using CAD/CAM technologies.
- Conventional sintering: sintering furnaces under oxidic atmospheres up to 1800°C.
- Grinding: Finishing on hard ceramics.
- Slip casting: Slurry formulation and production of parts.

LARGE SCIENTIFIC FACILITIES AND NATIONAL RESEARCH FACILITIES CONTRACTS

[F4E - GUTMAR] Development of a machinable aluminum nitride material (KALMAN) and production of 1500 pieces for junction boxes of IVS (2021)

[ITER EUROFUSION - CIEMAT] Development of complex shape alumina components for Maple-U test facility. Manufacturing of several components based on a 99.7% purity alumina for the multi-effect facility (Maple-U) that is designed to investigate material interactions for liquid metal breeder/coolant flow systems for fusion energy (2019)

[CERN] IT-4201 - Manufacturing of 380 blocks for collimators in the HL-LHC based on a graphite-molybdenum composite (2018)

[CERN] DO/TE - HV Ceramic Insulators for UHV Injection / Ejection Kicker Magnets (2018)

[ITER EUROFUSION - CIEMAT] Development of different self-doped alumina grades by using colloidal routes and advanced processing technologies (2014)

R&D PROJECTS

[CDTI] SINTEX: Development of a new generation of carbonaceous materials for the use in extreme environments (2018).

[H2020] CHARME (grant 685594): Next generation ceramic composites for combustion harsh environments and space (2016).

[Eurostars] CERCOAT (project E10527): New ceramic sputtering targets manufactured by SPS using tailored powders for TCO (Transparent Conductive Oxide) coating deposition (2016).

MARKETS

Nuclear / Defense / Automotive / Energy / Oil & gas

QUALITY CERTIFICATIONS, NUCLEAR QUALIFICATIONS

ISO 9001 / ISO 13485



Large scale Spark Plasma Sintering (SPS)

COMPANY NAME	NATEC (NUMERICAL ANALYSIS TECHNOLOGIES, S.L.)
ADDRESS	C/ Marqués de San Esteban, 52, Entresuelo D, 33206, Gijón, Spain
WEB	www.natec-ingenieros.com
TURNOVER	425k€ in year 2021
EMPLOYEES	8 in year 2021
SME	YES
CONTACT PERSON	Javier Ordieres
	POSITION General Manager
	PHONE +34 984 19 96 92
	EMAIL javier.ordieres@natec-ingenieros.com

COMPANY ACTIVITIES AND SKILLS

NATEC is an engineering company specialized in advanced analysis: nonlinear and coupled analysis in the mechanical, thermal and electromagnetic fields. Main capabilities demonstrated in projects carried out in the framework of ITER are:

Structural integrity assessment according to nuclear codes (RCC-MR, ASME and SDC-IC) of VV components, Port Plugs and In-Vessel components.

Welding process simulation to predict distortions during the manufacturing of the ITER components; Diagnostic Port Plugs, Toroidal Field Coil Cases and Vacuum Vessel.

Mechanical design, engineering and manufacturing analysis of ITER Equatorial and Upper Prot Plugs.

Electromagnetic analysis of plasma disruptions and other electromagnetic events.

LARGE SCIENTIFIC FACILITIES AND NATIONAL RESEARCH FACILITIES CONTRACTS

[F4E] F4E-OMF-0938-01: Provision of engineering support in the area of electromagnetic and electromechanical analysis of ITER components. (2020)

[ITER] ITER/CT/6000000209 Diagnostic structural engineering. Supply of engineering services for the ITER diagnostics. (2019)

[ITER] ITER/CT/14/4300001017 : Mechanical, thermo-hydraulic and electro-magnetic analysis of ITER diagnostics component (2017)

[ITER] ITER/CT/4200001628 - Mechanical Design and Manufacturing of ITER Diagnostics Components (2017)

[ITER] ITER/CT/4300001412. Engineering structural integrity justification for diagnostic attachments to the ITER VV and FE Analysis for the PPD Division. Thermal-structural analyses, fatigue assessments following EN 13445 (2016)

[ITER] ITER/CT/4300001396. Engineering support for the ITER Diagnostic Team. Thermo-mechanical, structural and seismic analysis of diagnostic components. FE models, load characterization, development of routines to update the models and insert detailed components. Creation of SLS for diagnostic system. (2016)

[F4E] F4E-OMF-0508-01. Electromagnetic Analyses of the European TBM Sets and the Collective Thompson scattering system. (2016)

[ITER] ITER/CT/4300001412. Engineering support for the IC&LH Section. Contribution to the design assessment. (2014)

[ITER] ITER/4300000850: Diagnostic Engineering Support with emphasis on bolometer and visible infra-red. (2013)

[ITER] ITER/CT/4300000866. Engineering support for the ITER diagnostic design, with particular emphasis in the areas of mechanical, TH and EM analysis. Checking of appropriate codes and standards against diagnostic designs: RCC-MR, ASME, SDC-IC. (2013)

[F4E] F4E-OMF-356: Provision of Engineering support in the area of mechanical analysis for the VV (ESMAVV). Vacuum Vessel Analysis: Structural, Thermomechanical, Coupled analysis. Structural integrity assessment following RCC-MR. Advanced analysis techniques (sub-modelling, sub-structuring, CMS...) several code assessments were performed according to RCC-MR regarding protection against P-type, S-type damage and Fatigue. (2012)

[ITER] ITER/CT/12/4300000598: Engineering support for mechanical, thermos-hydraulic and electro-magnetic analysis for the ITER diagnostic components. TH, EM, Structural, Seismic and Modal, leading to a Transient Dynamic analysis under EM loads from a Plasma Disruption event, and structural integrity assessment. (2012)

[F4E] F4E-2008-OPE-297 (ES-AC): Toroidal Field Coil Case Welding Simulation. Numerical simulation of the deformations/distortions induced in the TF coil structure by the closure welding procedure. (2011)

[F4E] F4E-2009-OPE-033 (ES-AC): Revision of the Structural Design Criteria for In-Vessel Components (SDC-IC). The SDC-IC was reviewed in order to incorporate the modifications included in the last versions of nuclear pressure equipment codes as ASME, RCC-MX and RCC-MR. (2010)

[F4E] F4E-2008-GRT-024 (PMS-DG): Detailed design of a representative equatorial port plug. (2009)

MARKETS:

Nuclear / Energy / Oil & gas

QUALITY CERTIFICATIONS, NUCLEAR QUALIFICATIONS

ISO 9001

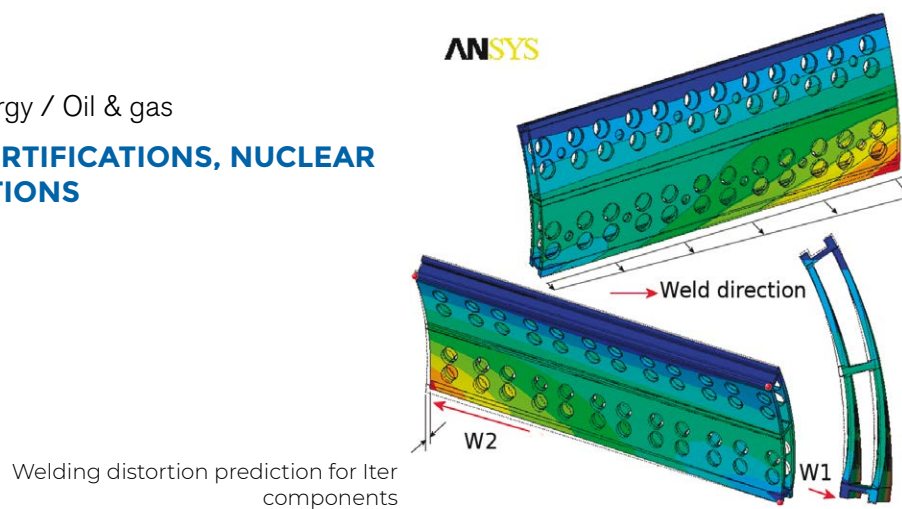



COMPANY NAME	NORTEMECÁNICA, S.A.
ADDRESS	Área Industrial de Tabaza I, parcel E-5, E-33469 Carreño, Asturias
WEB	www.nortemecanica.es
TURNOVER	8M€ in year 2021
EMPLOYEES	40 in year 2021
SME	YES
CONTACT PERSON	Susana Fernández
	POSITION Export Manager
	PHONE +34 985 57 98 57
	EMAIL comercial@nortemecanica.es

COMPANY ACTIVITIES AND SKILLS

Nortemecánica is a reference in manufacturing, assembly and commissioning of capital goods, machinery and spare parts for the industry, with over 30 years' experience.

Nortemecánica, posted sales in excess of €8 million, more than 80% of which comes from its intensive activity with countries all around the world.

In its own facilities (7.150m²), the following activities are developed: Boiler making and welding, Machining and adjustment, Assembly and testing, Quality control, Verification.

Nortemecánica is equipped with the high technology standard. We incorporate the latest technical advances, like for example, two Laser Trackers and a heated area for verification and assembly at constant temperature that has been recently built at our premises. This area and the heated room in which the 6 meter-long-milling machine is located, allows us to achieve tolerances without precedents (30 microns in 5 meters length).

LARGE SCIENTIFIC FACILITIES AND NATIONAL RESEARCH FACILITIES CONTRACTS

[ESS - ESS Bilbao] Manufacturing and supply of the Target Wheel Vessel for European Spallation Source ERIC at in Lund, Sweden (2019-2022).

[ESS] Manufacturing and delivery of Inner Shielding Blocks- Fifth Part for ESS Research facility located in Lund, Sweden, including inspection, testing and delivery (2020-2021).

[ESS - ESS Bilbao] Manufacturing and supply of Proton Beam Window Port Block and Proton Beam Window Vessel for European Spallation Source ERIC at in Lund, Sweden (2019-2021).

[ILL] Manufacturing and supply of H16 steel shielding for the Institut Max von Laue – Paul Langevin (2020).

[CERN] Manufacturing and delivery of yokes for magnets for the Proton Synchrotron (PS) (2019).

[ESS] Manufacturing and supply of 116 In-Bunker Base Plates for ESS Research facility located in Lund, Sweden, including inspection, testing and delivery (2019).

[ESS - ESS Bilbao] Manufacturing and supply of the Tuning Beam Dump Steel Shielding and T-Copper Block for ESS Research facility located in Lund, Sweden (2018-2019).

[XFEL] Manufacturing and supply of Insertion Device Support Systems. Production, assembly, testing, documentation, packing and supply of nine (9) undulator carriages. Motion control system, alignment and commissioning included (2018-2019).

[ESRF] Manufacturing and supply of ID Support Systems. Manufacture, testing, and delivery of four 2.0 M long In-Vacuum carriages and one prototype of Single Axis carriage for the ESRF-EBS accelerator complex (2018)

[ESRF] Manufacturing, assembly, testing and delivery to the ESRF site of 65 girders assemblies for the ESRF Storage Ring. (2016-2018)

MARKETS

Nuclear / Energy / Oil&gas

QUALITY CERTIFICATIONS, NUCLEAR QUALIFICATIONS

ASME, ISO 9001, ISO 3834-2



Proton Beam Window Port Block and Proton Beam Window Vessel for European Spallation Source ERIC

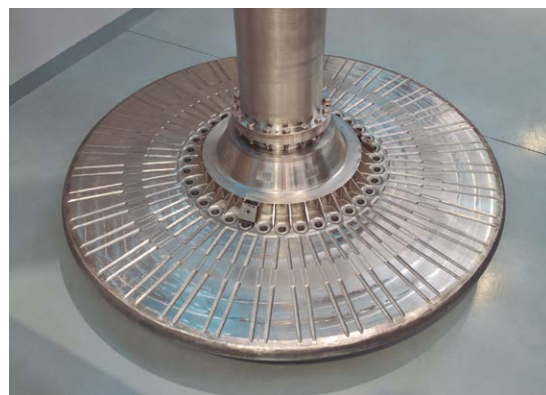

Target Wheel Vessel for European Spallation Source ERIC

COMPANY NAME	OBEKI ELECTRIC MACHINES
ADDRESS	C/Barazondo 3, Pol. Ind. Apatta, Apatta Erreka, 20400 Ibarra, Spain
WEB	www.obeki.com
TURNOVER	7.8 M€ in year 2021
EMPLOYEES	45 in year 2021
SME	YES
CONTACT PERSON	Gorka Astarbe Escudero
	POSITION General Manager
	PHONE +34 943 67 99 00
	EMAIL gorka.astarbe@obeki.com

COMPANY ACTIVITIES AND SKILLS

Obeki calculates, designs, manufactures and tests low voltage electric generators and motors for applications with special requirements such as not standard speed and torque requirements, harsh ambient conditions, vibration, shock, seismic certification for nuclear power plant installations, etc.

LARGE SCIENTIFIC FACILITIES AND NATIONAL RESEARCH FACILITIES CONTRACTS

[ITER] F4E-OPE-285 Supply of Slewing Motor for DCHLB Tokamak/Assembly Hall Cranes (2016)

Supply of electric motor. Design, manufacturing and testing of a 2,1 kW three phase electric motor for Slewing movement for DCHLB Tokamak/Assembly Hall Cranes.

MARKETS

Nuclear / Defense / Automotive / Naval / Energy / Oil & gas / Industrial & tower cranes, steel plants, water management

QUALITY CERTIFICATIONS, NUCLEAR QUALIFICATIONS

ISO 9001 / UNE 73401 (Garantía de la calidad en instalaciones nucleares)

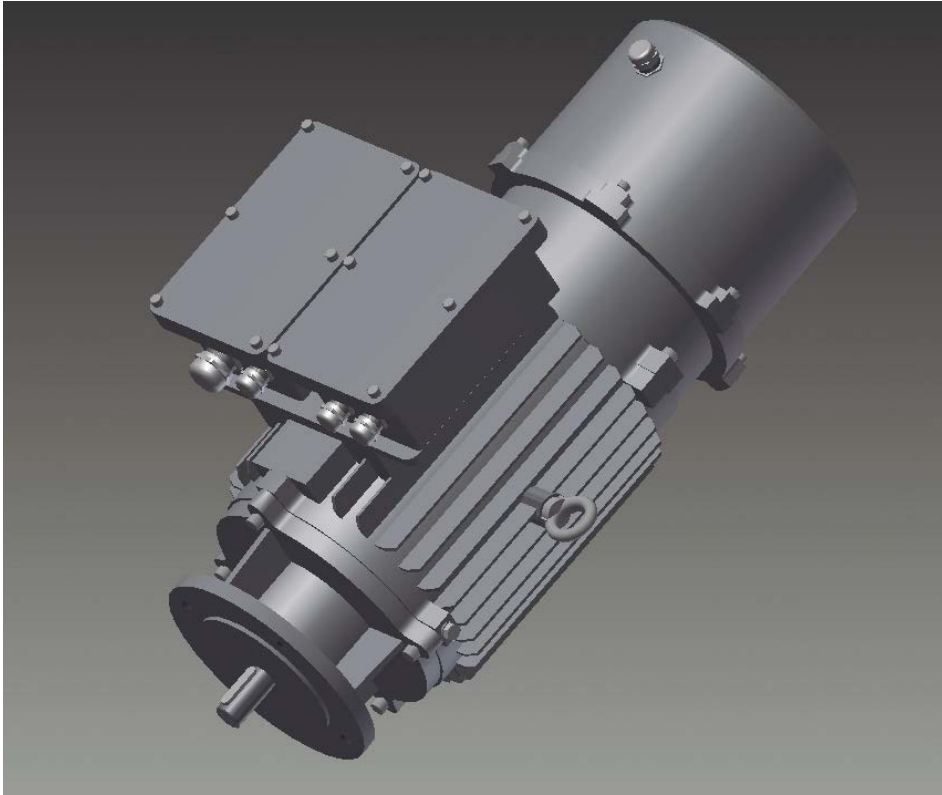

A set of OBEKI microspeed brake-motors manufactured for a French nuclear power plant

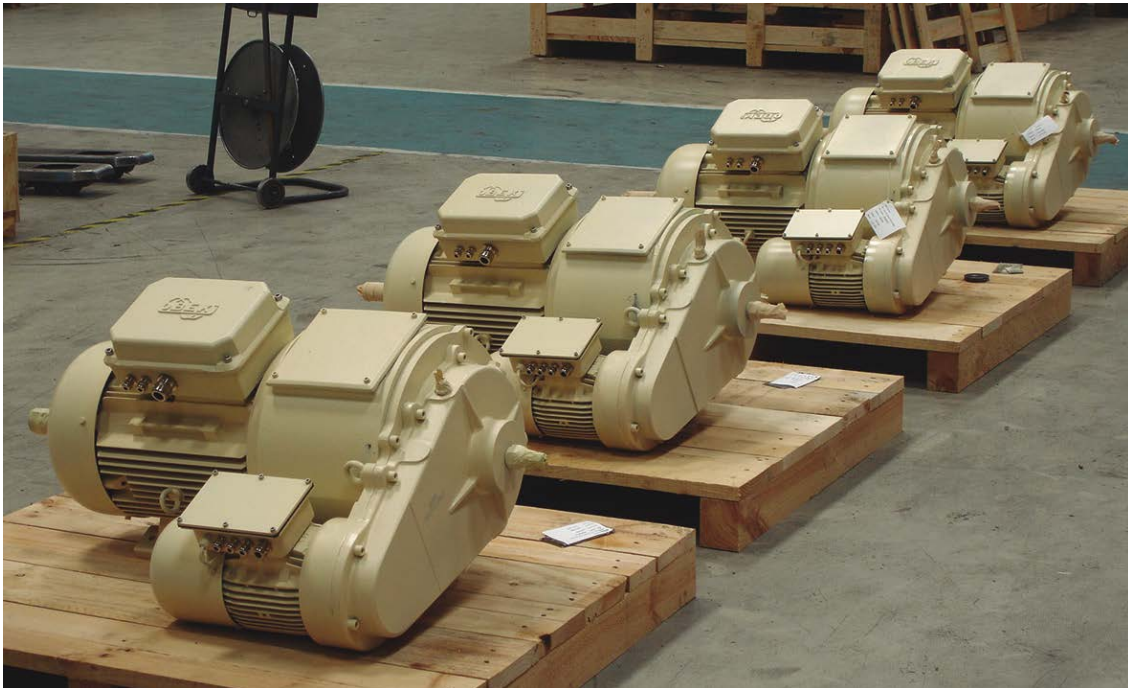

A set of OBEKI microspeed brake-motors manufactured for a French nuclear power plant

COMPANY NAME	OBUU TECH SL
ADDRESS	Avenida Gregorio Peces-Barba, 1, Leganés (Madrid) SPAIN
WEB	www.obuu.es
TURNOVER	500k€ in year 2021
EMPLOYEES	10 in year 2021
SME	YES
CONTACT PERSON	Mario Inglés Esteban
	POSITION Cofounder
	PHONE 0034 618 646 255
	EMAIL mario.ingles@obuu.es

COMPANY ACTIVITIES AND SKILLS

Obuu is a fast-growing SME with 3 main legs, focused on Aerospace, Energy, Railway and Big Science sectors:

-Engineering Services: We're problem solver engineers, experts in CAD design, FEM and CFD analyses, and prototyping. We accompany the customer through all the steps of the Life Cycle of the product, from the idea to the certifications and delivery.

- STOCKWATCH, Logistics Intelligence Cloud Platform: We have an innovative cloud platform for stock optimization, where our clients can link their investment in fixed asset from their maintenance of complex machines (aircraft, train, wind generators, etc) with their systems availability. So they can find the most optimum provisioning strategy, saving money while improving their efficiency.

-R&D: Thanks to our expertise in engineering and software, we are prepared to build very abroad projects linked to Industry 4.0 and IoT, where we put together our data analysis and software implementation capabilities with our material, processes, standards, and mechanics knowledge. Currently we are working into several R&D projects related below.

LARGE SCIENTIFIC FACILITIES AND NATIONAL RESEARCH FACILITIES CONTRACTS

[ITER] December 2019 IO/19/17922/DAL: Lot 7: VVTS Port Shroud Assembly Tools (2019)
– OBUU was leader of the consortium awarded with the contract with the objective of deliver, from the design to the manufacture, and testing of 3 tools for the assembly of the upper, equatorial and lower port shroud. The main challenge of this contract was to create the most optimal design form the design-to-cost point of view to be able to deliver all the sets within a limited budget. (Participants SOGECLAIR AEROSPACE and SGS).

R&D PROJECTS

Misiones CDTI, 2021, OPTIMUS – Optimus is a big scope R&D project in consortium with Airbus, Utingal, Inventia Kinetics, LGAI Technological Center, Metromecánica & Fimal Trading where our objective is to develop a system for the automated detection of manufacturing defects on aerospace flight parts through Machine Learning, Computer Vision, Artificial Intelligence and Image Processing techniques in order to reduce the quality inspection times, in collaboration with the CITSEM researching center from Universidad Politécnica de Madrid.

This project has been granted by CDTI, supported by Science and Innovation Ministry of Spain, and funded by European Union – NextGenerationEU.

CAM RIS3, 2019, TEMACON: Consortium led by Airbus and with participation of FIDAMC, IMDEA, and 3 SMEs. Our work package consists on creating a method of study for some physical properties of the largest carbon fibre part manufactured for an aircraft, by studying deformation and other parameters, and later building a tool to process this information automatically, identifying if the deformation produced by springback is or not in tolerance.

NEOTEC (CDTI), 2016: National funding program to start the development of a tool for a stock optimisation software.

RIS3 SMEs (Madrid Region), 2019: "Regional funding program to develop a new algorithm for the optimisation of consumables for maintenance stock, in collaboration with the Operational Research department of Universidad Complutense de Madrid".

DataPitch (UE H2020), 2019: "Develop a new stock optimization algorithm to be applied into the mass production sector with the multinational plastics company Greiner Packaging".

ESA-BIC (Madrid Region), 2017: Collaboration with European Space Agency to evolve the stock optimisation software into a cloud platform (SaaS).

Airbus Bizlab, 2015: Collaboration with Airbus to optimise the Initial Provisioning Lists (IPL) of Ground Support Equipment for some of their clients.

Renfe TrenLab, 2019: Develop of a stock optimization method into railway maintenance with Spanish national operator Renfe.

General Electric "Digital Industry Program" 2018: R&D program to integrate the stock optimisation cloud software into their Industry 4.0 and IoT cloud services platform "Predix".

ALSTOM GrabCAD Challenge, 2018: Challenge winners consisting in the Redesign the Structural Support of the Metropolis Metro Underframe.

Google for Startups Residency Program, 2020.

MARKETS

Nuclear / Defense / Automotive / Naval / Aeronautics / Space / Energy / Oil & gas / Railway

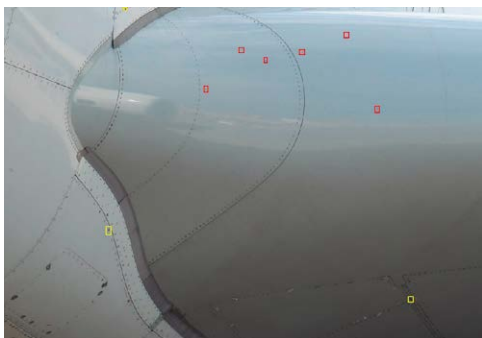

Visual inspection



TOOLS4FUSION post-image

COMPANY NAME
ADDRESS

OROLIA SPAIN SLU
 Calle Periodista Rafael Gómez Montero 2, CETIC-UGR 13,
 18014, Granada, Spain

WEB
TURNOVER
EMPLOYEES

sevensols.com/particle-accelerators-products/
 5 M€ in year 2021
 50 in year 2021

SME
CONTACT PERSON

YES
Pilar Gil Jaldo
POSITION Engineering Manager
PHONE +34 958285024
EMAIL pilar.gil@orolia.com

COMPANY ACTIVITIES AND SKILLS

Orolia solutions govern and protect the time and location integrity of systems that shape the world. With over 40 years of experience and a growing portfolio of innovative Positioning, Navigation, Timing, and GNSS Simulation solutions, our customer-first culture pushes the boundaries of quality, performance, and service

Orolia is the global leader in ultra-accurate and deterministic time transfer and frequency distribution for industrial and scientific applications. The company participates from early stages in diverse scientific infrastructures (particle accelerators and distributed radio-astronomy facilities) in Time and Synchronization, as well as frequency distribution.

Our contribution in different scientific infrastructures is the creation of break-through solutions for timing and for advanced control systems and diagnosis in particle accelerators. Among them it is worth mentioning developments such as LLRF, BPM or timing system based on White Rabbit.

Within the particular competences for scientific facilities, the following should be highlighted:

- Design and manufacturing of advanced electronic products: PCBs, Time and RF distribution equipment, customizable and safety critical platforms.
- Embedded systems programming: DSPs & SoC software, FPGA gateway, drivers development, customizable firmware for safety-critical and industrial applications.
- Fast control and system integration: including Hardware (VME, PCIe, microTCA) and Fast Feedback Control System Using FPGA for RF Signals
- Software for control system and remote control based on EPICS

LARGE SCIENTIFIC FACILITIES AND NATIONAL RESEARCH FACILITIES CONTRACTS

[EISCAT] Enquiry for White Rabbit based Time Distribution System: Procurement of WR Switches (2022)

[F4E] Management specification for the check out and repair of the PSYS of RF modules at LIPAc (2021); F4E-OFC-0935: Framework contract for the development of new functionalities and support services for LIPAc LLRF (2018); F4E-OFC-0911: Supply of High-Speed

digitizer and control system of the beam position monitor for the IFMIF/LIPAc accelerator (2018); F4E-OFC-0889 Development of new functionalities for LIPAc LLRF (2017)

[ESS Bilbao] Detail design and supply of eleven local oscillators and two local oscillator distributors for the 352 MHz section of the ESS ERIC accelerator (2020)

[CEA] Supply of the Beam Position Monitor electronics system (BPM) for the SARAF-PHASE II LINAC (2019); Supply of the Low Level Radio Frequency system (LLRF) for the SARAF-PHASE II LINAC (2019)

[GSI] Supply of hardware devices (White Rabbit Switches) (2019)

[CERN] DO-30856: Supply of hardware devices (White Rabbit Switches) (2018); DO-30550: Provision of Electronics Engineering Consultancy Services (2018)

[CIEMAT - INDRA] Low level Radio Frequency design and provision for IFMIF/EVEDA (2014)

R&D PROJECTS

[MICT] DIBA - Digitization of Interlocks through low latency communications (2022)

[CDTI - MISIONES] DONES-EVO - Industrial research in technologies and processes applied to IFMIF-DONES in order to evolve in the fusion program (2021)

[CDTI] ACTECA - Accelerators and related technologies for large scientific facilities (2018)

[H2020-EMPIR] WRITE - White Rabbit for Industrial Timing Enhancement (2018)

[CDTI- Innoglobal] TSN_4S: TSN-based deterministic networks for RF systems (2018)

[CDTI Innoglobal] White Rabbit Switch high reliability interoperability (2017)

[H2020] CLONETS: CLOck NETwork Services - Strategy and innovation for clock services over optical-fibre networks (2017)

MARKETS

Defense / Aeronautics / Space / Fintech, Telecom (5G)

QUALITY CERTIFICATIONS, NUCLEAR QUALIFICATIONS

ISO 9001 /ISO 14001



uTCA Beam Position Monitor



Standalone LLRF



RF Local Oscillator distributor



COMPANY NAME	PROACTIVE R&D
ADDRESS	Carrer de Ca n'Alzina 118 ^a , 08202 Sabadell, Barcelona, Spain
WEB	proactiverd.com
TURNOVER	455.112,52€ in year 2021
EMPLOYEES	7 in year 2021
SME	YES
CONTACT PERSON	Juan Herranz
	POSITION Director
	PHONE +34669556004
	EMAIL jherranz@proactiverd.com

COMPANY ACTIVITIES AND SKILLS

Proactive R&D provides valuable expertise, equipment and leadership in the field of Research and Development. With skills and capabilities on High precision mechanics, Optomechanics, Complex Finite Element Analyses, UHV design, Cryogenics design, System integration, Procurement of equipment.

Proactive R&D proposes an extremely flexible and collaborative framework according to the customer's needs. We can provide from punctual and specific support within one single phase of the project, until full end-to-end -from concept design to final verification of the hardware work-packages.

LARGE SCIENTIFIC FACILITIES AND NATIONAL RESEARCH FACILITIES CONTRACTS

- [ESRF] – Supply of a water cooled Secondary Slit System for ID26 beam line - (2022)
- [ESRF] – Supply of a Sub-microm Positioning System for ID21 - (2022)
- [CEA] – Supply of a SEM-GRID system for a medical proton LINAC - (2021)
- [GSI] – Supply of a 0.5 mm pitch and 64 wire GRID for FAIR project - (2022)
- [ESS-Bilbao & SCK CEN] – Supply of and Emittance Metter Unit for MYRRHA project - (2022)
- [ESRF] – Supply of a 3 axis High Precision Positioning System for 80 kg loads - (2021)
- [CIEMAT] - Design of tooling for the manufacturing of the coils of the internal dipole MCBXFA (2020)
- [CNA] - Supply of a Vacuum Chamber with Temperature Control System form -150° to 200° - (2019)
- [ILL] - Supply of a Collimator for Neutros - (2019)
- [ILL] - Supply of Neutron Shielding for the XTremeD Monochromator (2019)
- [ILL] - Final Design and Procurement of an Optical Bench for the instrument XTremeD (2019)
- [ILL] - Final Design and Procurement of an Monochromator Support for the Instrument XTremeD (2019)

[ESS BILBAO] - Design and Procurement of 2 Emittance Meter Units for the MEBT of ESS (2018)

[ESS BILBAO] - Design and Procurement of 2 Emittance Meter Units for the MEBT of ESS (2017)

[ESS BILBAO] - Design and Procurement of 6 Scrapers for the MEBT of ESS (2017)

[ESS BILBAO] - Design and Procurement of 3 Wire Scanners for the MEBT of ESS (2017)

[CENTRO ASTRONÓMICO HISPANO ALEMÁN (CAHA)]- Supply of the Optical Mount for the Echelle of CARMENES instrument (2017)

[ESRF] - Supply of a water cooled Secondary Slits System for ID 21 beam line (2017)

[INSTITUTO DE ASTROFÍSICA DE CANARIAS (CAHA)] - Supply of the Optical Mount for the Fiber Exit Unit of CARMENES instrument (2015)

[ESRF] - Supply of a magnetic field measurement system for the Cryogenic Permanent Magnet Undulator (CPMU) (2015)

R&D PROJECTS

Development of a Cryo Preparation Unit able to deliver gas nitrogen in a large range of temperatures (80 – 180 K) with very high stability (few mK). These two characteristics give this device great versatility in terms of its field of application. This project is funded by the Spanish State Research Agency.

MARKETS

Science Industry

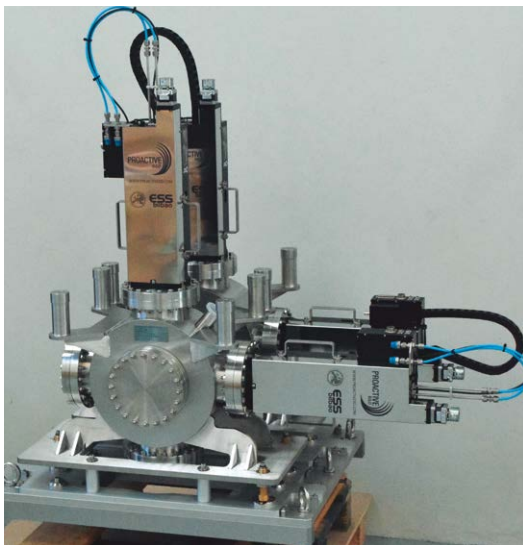

Emittance Meter Unit for MYRRHA project (ESS-Bilbao & SCK CEN)

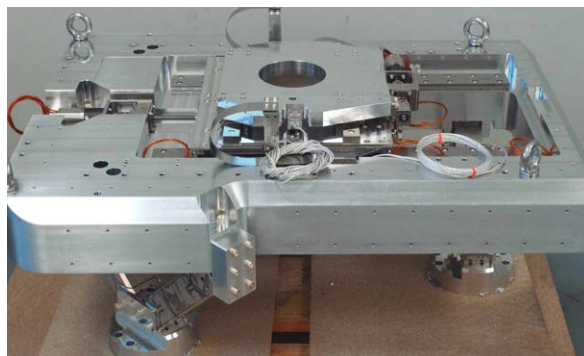

Sub-Micron Positioning System for ESRF ID21 Beamline

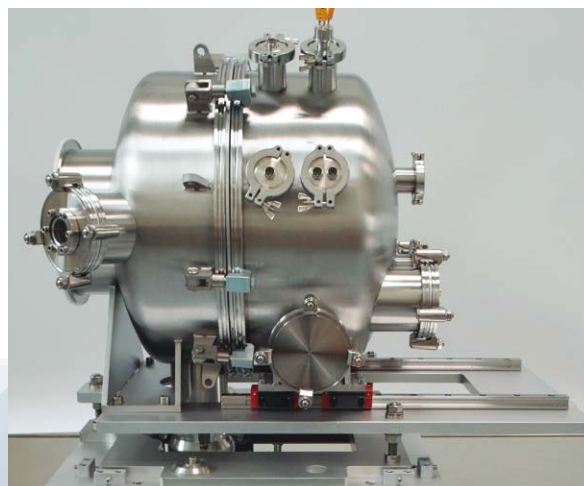

Vacuum Chamber with Temperature Control System from -150° to 200° for CNA

COMPANY NAME	PROCON SYSTEMS
ADDRESS	Arquímedes 26, Badalona 08918, Spain
WEB	www.proconsystems.net
TURNOVER	7,6 M€ in year 2021
EMPLOYEES	70 in year 2021
SME	YES
CONTACT PERSON	Daniel Marchante
	POSITION Manager Science and Digital Industry
	PHONE +34 93 460 99 40
	EMAIL marchante@proconsystems.net

COMPANY ACTIVITIES AND SKILLS

Procon Systems is an engineering company specialised in the design, manufacture, and integration of tailor-made automation projects such as car body assembly lines and surface treatment robotized solutions for the automotive industry. Moreover, Procon Systems develops highly sophisticated control systems, personnel safety systems and restricted access control systems for large scientific facilities.

- Key projects in the sphere of control and supervision.
- Functional personnel safety system.
- Engineering development and support services.
- Present in the Science market since 2005
- Engineering services supplier of Europe's main scientific facilities such as CERN or ITER.
- Control system development for different systems (Access Control, HVAC,..)

LARGE SCIENTIFIC FACILITIES AND NATIONAL RESEARCH FACILITIES CONTRACTS

- [ALBA] FAXTOR Beamline (2022)
- [F4E] System, Instrumentation and Control Engineering Support (2021)
- [ITER] Supply Contract for SCWS-TCWS I&C cubicles (2021)
- [ITER] Central Safety System – Occupational Safety (CSS-OS) (2020)
- [ESO] Supply contract fro Electronic Cabinets for the ELT M1 Cell (2020)
- [CERN] R744 SYSTEM A - DEMO primary control (2020)
- [ESO] 8-M Coater System Overhaul (2019)
- [ALBA] NOTOS Beamline (2019)
- [ALBA] LOREA Beamline (2018)

- [CERN] SPS Personnel Protection System (PPS) (2017)
- [ESS] Control System (Process, Infrastructure and Safety) Consultancy(2017)
- [CERN] Ventilation Control Systems TDC2 TCC2 (2016)
- [CERN] HVAC Control System BAF3 (2015)

R&D PROJECTS

- Comprehensive Traceability Ecosystem (2018)
- PROTOCOLDAC Technological Demonstration at Prototyping Level of Experimental for Conventional Control Systems for Advanced Nuclear Facilities (2015)

MARKETS

Automotive / Energy / Big Physics

QUALITY CERTIFICATIONS, NUCLEAR QUALIFICATIONS

ISO 9001 / ISO 14001 / IEC 15504 Capability Level Software Life Cycle Processes



CERN PPS SPS Test Platform



I&C Cabinets Procon Systems for ITER



COMPANY NAME	QUASAR SCIENCE RESOURCES, S.L.
ADDRESS	Camino de las Ceudas 2, 28232, Las Rozas de Madrid, Madrid
WEB	quasarsr.com
TURNOVER	1.609.107,74 euros in year 2020
EMPLOYEES	22 in year 2020
SME	YES
CONTACT PERSON	Ignacio de la Calle Pérez
	POSITION Managing Director
	PHONE 620029061
	EMAIL ignaciodelacalle@quasarsr.com

COMPANY ACTIVITIES AND SKILLS

Quasar Science Resources, S.L. is a private company that provides consulting Software and System Engineering services for R+D projects targeted at Research Centres, Universities and Private Companies. We operate in the Madrid (Spain) area but our customers include national and European partners both in the public and private sectors. Quasar has strong expertise in scientific software development and data reduction techniques, handling and exploitation of scientific databases, archive engineering and data mining, computer systems engineering, including virtual machine infrastructure, network, data storage and backup. Quasar has ample experience working in international collaborations in the fields of ground and space-based scientific astronomical observatories and has presence at the European Space Astronomy Centre (ESAC) within the Frame Contracts for Industrial Support to ESA. The work at ESAC focuses on four main areas: Science Operations Support, Software Engineering, Development and Maintenance Support, IT Support to Scientific Missions and the ESA Science Data Centre. Quasar has expertise in the field of SSA, especially in the field of optical robotic telescopes. In 2018 Quasar was accepted into the ESA Business Incubation Centre (BIC) Madrid Region for two years with the SIMBAD project. SIMBAD (Sentinel Imagery MultiBand Analysis and Dissemination), is dedicated to the processing of Sentinel imagery and the extraction of EO-based products.

LARGE SCIENTIFIC FACILITIES AND NATIONAL RESEARCH FACILITIES CONTRACTS

[ESA] - SSA P3-NEO-I B - Installation and Commissioning of TBT2 in La Silla (Chile), (2019 - 2022).

[CNES - Share My Space] - Automatisation et système bord autonome pour la gestion des risques de collision (2020 - 2022). Identify the need and the feasibility of automating the collision risk management process for a wide range of satellite missions.

[ESA - Deimos Space S.L.] - S1-PD-10 Software Maintenance (2021 - 2024). Maintenance, including the provision of support to operations, of the NEOCC for what concerns the continued availability and usage of the NEO data systems.

[ESA] - S1-PD-06.2 - Software Development for NEO Observational Activities (2022 - 2024). To improve and maintain the ESA's Test-Bed Telescope's (TBT) software; and to develop a service to support astronomers with ArtSat/NEO identification.

[Yebees Observatory] – Technical assistance for the commissioning of an astronomical and geodesic correlator for RAEGE and EU-VGOS at the Yebees Observatory, a part of the TNART project cofunded with ERDF (2022 - 2023).

R&D PROJECTS

H2020-COMPET-2015 - A Gaia and Herschel Study of the Density Distribution and Evolution of Young Massive Star Clusters - grant agreement No 687528 - <https://starformmapper.org/>

MSCA-ITN-2015-EID - STARS that 'R' Young: When do stars form in clustered environments? - grant agreement No 676036 - <http://starry-project.eu>

(GenObIACM) S2017/BMD-3773 - Genetics and Artificial Intelligence Against Obesity.

IND2017/IND-7793 - Comunidad de Madrid Industrial Doctorate programme 2017 (UAM) - Molecular identification by machine learning analysis of Atomic Force Microscopy images.

ESA Incubation Program 2018 - SIMBAD – A Scientific Exploitation Platform dedicated to the processing of Sentinel imagery and the extraction of EO-based products.

IND2019/TIC17146 - Comunidad de Madrid Industrial Doctorate programme 2019 (UCM) - Quantum artificial intelligence techniques in reinforcement learning.

ND2020/AMB-17747 - Comunidad de Madrid Industrial Doctorate programme 2020 (UPM) – Evaluation of agricultural systems by means of satellite remote sensing time series and dynamic prediction models.

DIN2020-010979 - Industrial Doctorate Program Agencia Estatal de Investigación 2020 (UCA) – Development of models to characterize the quality of coastal waters using satellite remote sensing techniques.

MARKETS

Space / Earth Observations / Astronomy

QUALITY CERTIFICATIONS, NUCLEAR QUALIFICATIONS

ISO 9001



Remote Sensing Earth Observations SIMBAD project incubated by ESA BIC. In the image, maps are shown for Water Quality monitoring of the region of Mar Menor (Spain).

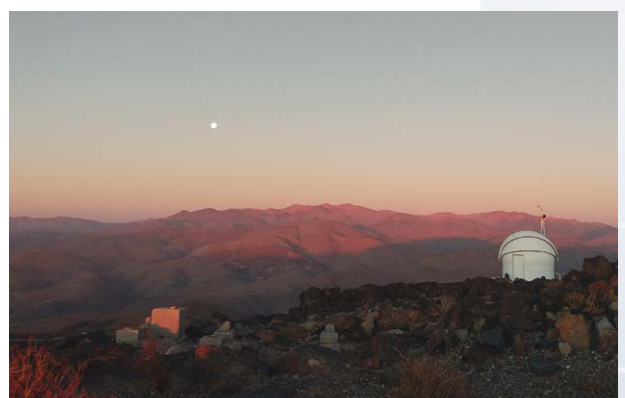

Robotic Test Bed Telescope (TBT), La Silla, Chile

COMPANY NAME	RDT INGENIEROS
ADDRESS	Astondo Bidea edificio 614, 48160 Derio
WEB	www.rdtingenieros.com
TURNOVER	42.290.789,00€ in year 2020
EMPLOYEES	1300 in year 2020
SME	NO
CONTACT PERSON	Manuel Muñoz Luengo
	POSITION Managing Director (Affiliate LUMIKER Aplicaciones Tecnológicas S.L.)
	PHONE 689227406
	EMAIL manuel.munoz@lumiker.com

COMPANY ACTIVITIES AND SKILLS

RDT is an International Engineering Group, founded in 2007 at Bilbao. RDT has had a constant growth majorly in the Energy and Transport Sectors. Our purpose is to make engineers enjoy engineering by providing flexible outsourced services to major clients, innovating and developing high technology engineering solutions.

Within its development the Group has been developing innovative companies from a start-up phase, that bring deep knowledge and new products to the market such as; INTENANCE: a leader in Industrial and Nuclear Power Plant Maintenance, RDT Studio: with capabilities in Scanning, BIM & 3D Digital Twins, Drone Imaging and Maintenance Inspections, AXIA Team: for the digital transformation of your BoP & LUMIKER: providing Critical Asset Management Solutions with Fiber Optic Sensors.

LARGE SCIENTIFIC FACILITIES AND NATIONAL RESEARCH FACILITIES CONTRACTS

[ITER - EMPRESARIOS AGRUPADOS]:

- Pipe Design with SP3D and Supports Modelling through LICAD.
- I&C Design FWP Design and Civil Structures Analysis for the Tokamak Complex (Building 11, 14 and 74).
- Design Support of Electrical substations 400KV PPEN /SSEN.
- Piping Design with Catia V5 for the Demonstration Fusion Power Reactor.
- First Wall Panel design studies and project functional support
- Field Task Force Design of Piping integration using Catia V5.
- Fusion Power Reactor Structural and Supports Design Studies
- ANSYS Analysis for the Tokamak building

[ESA – SENER]:

- MELISSA Process Engineering Support
- SCRIPT Guidance System Development Support

- SW / Firmware /HW Development services for AURORA and METEOSAT
- METOP SW development services
- AOCS/GNC HW development for the JUICE program
- AOCS/GNC Development for PROBA-3
- HW / Firmware Development for EXOMARS, GAIA and ECLID

LAST R&D PROJECTS

- BRAGG: Predictive Maintenance System Development based in Bragg Networks.
- PMEL: Sensor technologies applied to the predictive maintenance of electrical grids.
- PREMAN: Predictive Maintenance Platform.
- CABLESENS: Underground cables remote monitoring based on optical sensors platform.
- APC CABLESENS: Intelligence Generation Monitoring System applied to Cables.
- Brillouin Interrogator development oriented to Aerospace Composite Manufacturing.
- PHOSENS – HV Short-Circuit measuring with optical sensors for Smart-Grid monitoring.
- SPADI: Ampacity Predictive System for Dynamic lines monitoring.
- INTERSEN: Development of passive EDFA amplifier, integrated in Faraday interrogators.
- EOMONIT: CMS Blade Monitoring system for Wind Turbines Generators.
- FLOAT&M: Floating Platform, Connector & Cable innovative monitoring solutions.

MARKETS

Nuclear / Defense / Automotive / Naval /
Aeronautics /Space / Energy / Oil & gas

QUALITY CERTIFICATIONS, NUCLEAR QUALIFICATIONS

ISO 9001 / ISO 14001 / ISO27001



Optical Fiber Multiplexer

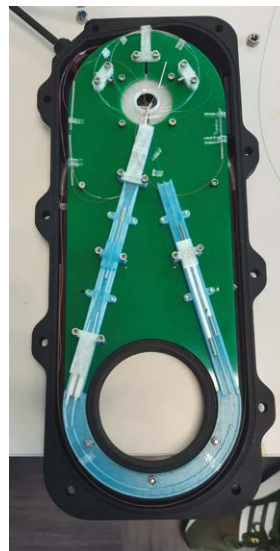

Optical Current
Transformer



Cable Monitoring
Interrogator

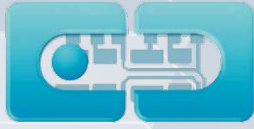

COMPANY NAME	ROMPAL INGENIEROS S.A.U.
ADDRESS	C/ Montserrat Roig, 23. Pol. Ind. Pedrosa
WEB	www.rompal.es
TURNOVER	7,55M€ in year 2021
EMPLOYEES	50 in year 2021
SME	YES
CONTACT PERSON	Benito García Santos
	POSITION Sales Manager
	PHONE +34 93 261 84 20
	EMAIL bgarcia@rompal.es

COMPANY ACTIVITIES AND SKILLS

ROMPAL is an Electronic Manufacturing Services (EMS) company founded in 1972. Since then, it has been focused on the industrial and scientific sector which allows it to respond to production series of short and large units.

Specialized in high technology and quality. First EMS in Spain that assembles SMD in 1985, BGA in 1999 and also PoP (Package on Package) in 2008.

Ability to assemble all existing packages in the market (PoP, Flip-Chip, ...) and also foot-print, up to 01005 in passive components.

To achieve the highest quality, Rompal uses SPI, AOI and Rx machines during the production process. Also, the ability to carry out any type of test (boundary scan -JTAG-, test in circuits, functional test ...) to deliver a final device with all the guarantees.

If necessary, there is the possibility of applying a conformal coating and mechanical mounting.

LARGE SCIENTIFIC FACILITIES AND NATIONAL RESEARCH FACILITIES CONTRACTS

[IFIC] Control and Power circuits. KM3NeT - Neutrino Telescope under the Mediterranean Sea (2022-2023)

[GRANADA UNIVERSITY] White Rabbit. KM3NeT - Neutrino Telescope under the Mediterranean Sea (2022)

[CPPM] Control and Power circuits. KM3NeT - Neutrino Telescope under the Mediterranean Sea (2020-2021)

[NIKHEF] Control and Power circuits. KM3NeT - Neutrino Telescope under the Mediterranean Sea (2019)

[SEVILLA UNIVERSITY] DAQ-ROC4SENS for CMS Upgrade (2019)

[CERN] Controllers for high-speed data transmission of collision results (2017-2018)

[CERN] Manufacture of circuits to increase the energy of collisions (2017-2018)

[STARLAB] Equipment to track satellites from land to monitor sea level (2016)

[CERN] Sensors located in the detectors that discovered the Higgs boson (2007)

R&D PROJECTS

As Rompal's main activity is focused on EMS, it does not develop R&D projects directly, but can work side by side to provide advice and guidance during the product design phase, to optimize its industrialization.

MARKETS

Nuclear / Defense / Automotive / Naval / Aeronautics / Energy / Oil & gas / Telecom, Investigation, Electromedicine, Energy

QUALITY CERTIFICATIONS, NUCLEAR QUALIFICATIONS

ISO 9001/ IPC-610, JEDEC



3 SMD component assembly lines

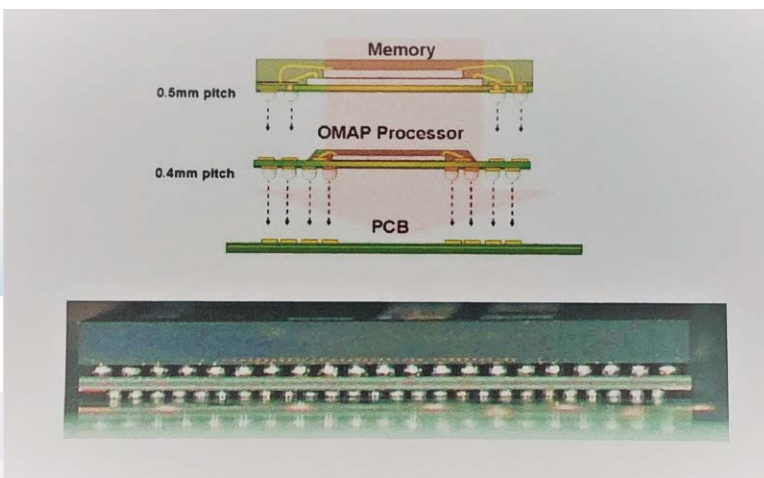

Package on Package Technology (POP)



Front view of the Rompal Facilities

COMPANY NAME	SCHWARTZ HAUTMONT CONSTRUCCIONES METÁLICAS S.A.
ADDRESS	Av. de la Canonja 9, 43480 Vila-seca (Tarragona, SPAIN)
WEB	www.shcm.es
TURNOVER	60,3M€ in year 2021 (audit ongoing)
EMPLOYEES	circa 500 in year 2021
SME	NO
CONTACT PERSON	Josep M. Sans
	POSITION Project Manager
	PHONE +34 977390000
	EMAIL jmsans.shicsa@shcm.es

COMPANY ACTIVITIES AND SKILLS

Design, fabrication and installation of complex steel structures (plants, modular units, singular structures) and pressure vessels (columns, reactors, heat exchangers) for the Oil & Gas (refining, petrochemical, LNG, offshore and subsea), Power & Energy (generation, power plants) and, in lesser amount, for the Scientific, Government, Civil Construction and Recreation industries.

LARGE SCIENTIFIC FACILITIES AND NATIONAL RESEARCH FACILITIES CONTRACTS

[NRAO] Fabrication of the ng-VLA 18m radio telescope prototype (2022-2023) USA

[ESA] Design, supply, and installation of a 35m deep space antenna (2021-2025) New Norcia

[NASA / JPL] Supply and installation of two 34m deep space antennas (2017-2020) Madrid

[NASA / JPL] Supply and installation of two 34m deep space antennas (2012-2015) Canberra

[NASA / JPL] Supply and installation of one 34m deep space antenna (2001-2004) Madrid

[IGN] 40m radio telescope (Instituto Geográfico Nacional) (2002-2005) Yebes

[Grantecan] Supply and installation of 10,4m multimirror telescope (2001-2005) La Palma

[Carnegie Inst] Magellan II Telescope enclosure, fabrication (1998-1999) Chile

[Carnegie Inst] Magellan I Telescope enclosure, fabrication (1994-1996) Chile

[NASA / JPL] Supply and installation of one 34m deep space antenna (1995-1997) Madrid

[NASA / JPL] Supply and installation of one 34m deep space antenna (1994-1996) Canberra

[CARA] Keck Telescope (California Ass. for Research in Astronomy) (1989) Hawaii

[NASA / JPL] Supply and installation of one 34m deep space antenna (1986)
Goldstone

[NASA / JPL] Supply and installation of one 34m deep space antenna (1985)
Madrid

MARKETS

Nuclear / Space / Energy / Oil & gas / Science / Government / Civil Construction /
Recreation

QUALITY CERTIFICATIONS, NUCLEAR QUALIFICATIONS

ASME / ISO 9001 / ISO 14001



DSN 34m reflector dish back structure shop fabrication



DSN 34m antenna installation in Australia

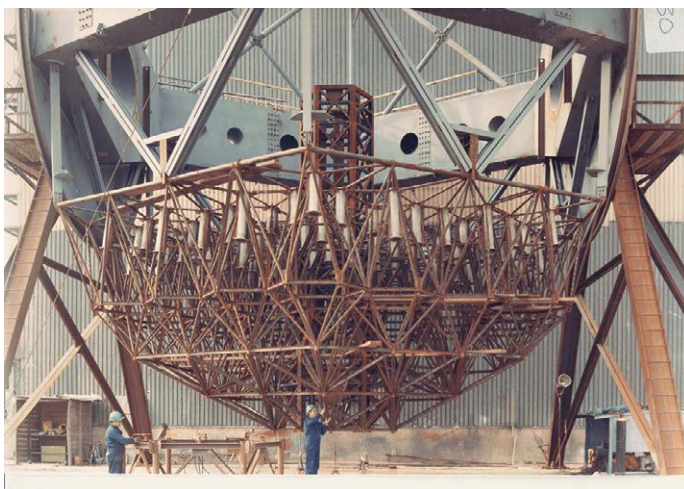

Keck telescope shop fabrication



GranTeCan installation in La Palma

SCIENTIFICA

COMPANY NAME	SCIENTIFICA INTERNATIONAL SLU
ADDRESS	Pol. Ind. Sigma, C/ Xixilion 2 Bajo, Pab.10 - 20870 Elgoibar, Gipuzkoa, SPAIN
WEB	www.scientifica.es
TURNOVER	201k€ in year 2021
EMPLOYEES	6 in year 2021
SME	YES
CONTACT PERSON	José Manuel Núñez García
	POSITION CTO
	PHONE +34 943 12 72 85
	EMAIL jmnunez@scientifica.es

COMPANY ACTIVITIES AND SKILLS

Scientifica is a company devoted to the development and manufacturing of electronics for the science and space markets. With experience and technical skills in four main core technologies (Electronics, Signal processing & Control, Precision mechanics and Composite materials & Structures), Scientifica has collaborated with several European scientific facilities and institutions like ISIS, CIEMAT, ESS-Bilbao, ILL, HZB, JET and CERN.

Scientifica has an important activity in the development of radiation detectors in various fields, such as position sensitive neutron detectors for neutron scattering applications and ionization chambers for fusion diagnostics applications.

It is also important its activity in the design and development of electronic systems -analog and digital- for different applications like SiPM readout integrated circuits, diagnostics (fusion and particle physics), motion control and detectors.

In addition, expertise in composite materials leads to a remarkable activity in radiation hard materials and other new materials and parts developed and manufactured for structural and functional purposes in a wide range of applications.

LARGE SCIENTIFIC FACILITIES AND NATIONAL RESEARCH FACILITIES CONTRACTS

[CIEMAT] Supply of improved H/D Permeation Sensors for PbLi metal liquid loop (2022)

[CEA – AVS] Development of motion control system for Collimation Slits based on EPICs platform (2022)

[GEORGIA TECH] Supply of eMUSIC read-out ASICs for Cherenkov Telescopes for Ultra-high Energy Neutrinos (2021)

[ESA – AVS] Cryogenic PCBs for Control Switching of the filter wheel mechanism (2021).

[ZMNH, Center for Molecular Neurobiology Hamburg] Supply of a set of Readout Electronics Boards for SiPM sensor array (2020).

[ILL] XtremeD (3He trench-MWPC Neutron Detector) Prototype and first modules assembly (2018)

[GTC - AVS] Design and supply of control system of the MOS of MEGARA instrument (2017)

[JET] Design and supply of 16 channel Low Noise Transimpedance Amplifier (2016)

[ESS Bilbao] Design and supply of multipixel neutron detector platform (2016)

[ILL] Manufacturing of 6 CF analyzer's structures (2012)

[ISIS] Supply of position sensitive neutron detector for PEARL Instrument (2010)

R&D PROJECTS

[HAZITEK] LUR-1, Development on technologies for microsátélites systems (2022).

[H2020] Collaborative robotic control system for remote gantry unfolding and cable robot control (2021).

[IFIC] Development of KS and XS thermal conductive composite (2019)

[CERN Collaboration] Design, simulation and test of a Faraday Cup for beam diagnostics (2011)

MARKETS

Nuclear / Space / Particle Accelerators



16 channels Digital Signal Processing System (FPGA)

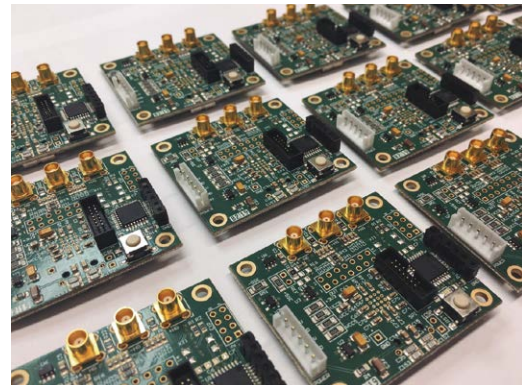

eMUSIC SiPM readout miniBoards



EGSE for Sampling Tool Mechanism



WLSF Position Sensitive Neutron Detector



COMPANY NAME	SCIENCE ENGINEERING ASSOCIATES S.L.
ADDRESS	Av. Atenas 75, 28232 Las Rozas, Madrid
WEB	www.seaingenieria.es
TURNOVER	60k in year 2021
EMPLOYEES	2 in year 2021
SME	YES
CONTACT PERSON	Pedro Ortego
	POSITION Director
	PHONE +34 695 183 077
	EMAIL p.ortego@seaingenieria.es

COMPANY ACTIVITIES AND SKILLS

Highly specialized in the analysis of radiation transport problem by the use of three-dimensional Monte Carlo tools, mainly MCNP family of codes. Main capabilities in the area of fusion include:

- Design of shielding elements, design of buildings layout for the installation of radiation sources, design of shielding materials for fusion spectrum
- Analysis of neutron damage, neutron activation, neutron heating and gas production
- Analysis of residual dose at shutdown due to the neutron activation of the shielding materials and of the equipment near the source. Impact on Waste Management.
- Determination of residual dose maps. Design of shielded containers.
- Licensing of Nuclear and Radioactive Facilities

LARGE SCIENTIFIC FACILITIES AND NATIONAL RESEARCH FACILITIES CONTRACTS

[ITER Organisation] Neutronic analysis for H-alpha, CXRS Edge and Dust Monitor diagnostics systems (2020)

Analysis of neutronic damage and heating rate in the vessel inner surface and superconducting magnets due to a cutout in a shielding module around HNB3. Reduction of damage and heat rate in the molybdenum first mirrors by retracting them off plasma in CXRS Edge system.

[CIEMAT] Support in neutronic analysis services for the DONES safety design (2020)

Preparing the Licensing of the DONES Phase I based on the experience of LIPAc in Japan. Analysis of skyshine at the wall facility, safety design for complementary research lines.

[LSC – Canfranc Underground Laboratory] Shielding design and licensing as Radioactive Facility (2019)

Design of the room shielding and the characteristics of the storage facility for radioactive sources. Preparation of the documentation for the licensing process with Spanish Regulator

[CIEMAT] Preliminary design of IFMIF beam dump (2016)

Conceptual design of the IFMIF facility defining the thickness of the building walls around and the ceiling over accelerator beam dump. Calculation of dose at operation and after shutdown. Definition of a shielding device to reduce the activation in front of the beam dump opening

[F4E] Shielding design and residual dose analysis for European TBM (2013) (subcontractor)

Design of the shield layout for the European Tritium Breeding Modules intended for installation in Equatorial Port Plug #16 of ITER. Includes the study of the different shielding material options, different layouts for the coolant pipes through the shielding, the calculation of the activation of the shielding itself and of the surrounding structural elements and of the equipment located nearby and the final calculation of the residual dose after shutdown.

R&D PROJECTS

[ITER Organisation] Design of shielding material for Diagnostics modules based on vitrified B4C (2016)

Development of a shielding material based on boron carbide with the use of a binding made of boron silicate. Coordination of manufacturing and test performance. Design of the composition and analysis of the shielding effectiveness in a generic diagnostics module. Impact on waste disposal according to French regulation.

MARKETS

Nuclear

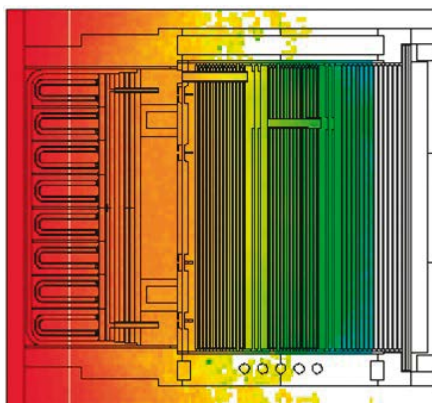
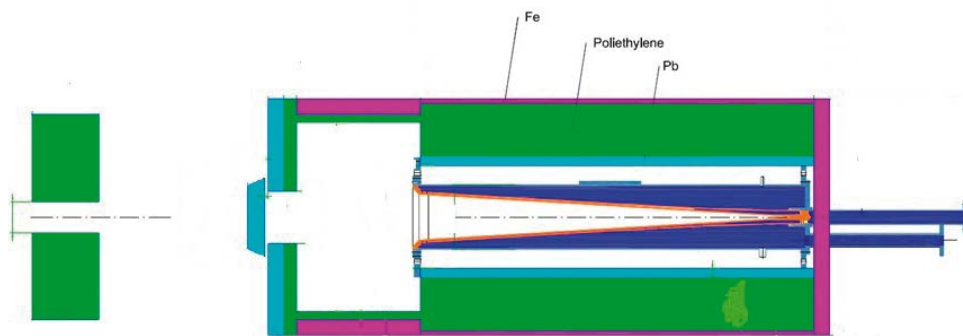

Neutron flux gradient through the TBM shielding

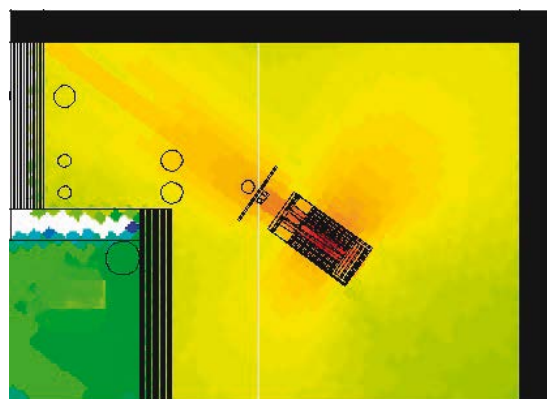

Neutron dose around DONES Beam Dump



SENER

Aeroespacial

COMPANY NAME
ADDRESS

SENER AEROESPACIAL S.A.
C/ Creu Casas i Sicart, 86-88. Parc de l'Alba.
08290 Cerdanyola del Vallès (Barcelona)

WEB
TURNOVER
EMPLOYEES
SME
CONTACT PERSON

www.aerospace.sener
110 M€ in year 2021
790 in year 2021
NO
Joan-Manel Casalta
POSITION Science Programs Director
PHONE +34 93 227 65 63
EMAIL joanmanel.casalta@aeroespacial.sener

COMPANY ACTIVITIES AND SKILLS

SENER is a private engineering and technology group founded in 1956. It seeks to offer its clients the most advanced technological solutions and enjoys international recognition thanks to its independence and commitment to innovation and quality.

SENER Aeroespacial is the company inside the group for Space, Defense and Science markets with long tradition in mechanical systems and radio-frequency systems with the incorporation of Tryo Group in 2019. In the field of Large Scientific facilities, SENER Aeroespacial is recognized for its capability to perform multi-disciplinary projects in opto-mechanics, instrumentation including optics, mechanics, electronics and SW and large mobile structures, actuators and control infrastructures.

LARGE SCIENTIFIC FACILITIES AND NATIONAL RESEARCH FACILITIES CONTRACTS

Astronomy: Mechatronics, optomechanics and structures for Ground and Space telescopes
[ESO] ELT M1 Segment Manipulator. Mechanism to handling M1 mirror segments (2021 -)
[IAC] EST M1 Cell. Preliminary design for the EST 4m M1 mirror and support (2021-)
[ESO] ELT M5 Cell. Tip-tilt and Alignment mechanisms for 2.7m mirror (2020 -)
[ESO] ELT M2 and M3 Cells. Mechanisms for 4m and 3.5 tons mirrors (2017-)
[IAC/ING] WEAVE Prime Focus Optical Corrector and Translation System (2015- 2020)
[ESO] ALMA radiotelescopes, Amplitude Calibration Robotic Arms: 70 units (2008-2012)
[ESO] E-ELT M5 Field Stabilisation Unit Conceptual design and Demonstrator (2007-2010)
[ESO] VLT GRAAL Main Assembly. Rotator with Adaptive Optics (2007-2010)
[CEFCA/Univ Sao Paulo] JPCam Actuator System. High Precision Hexapod (2012-2015)
[GTC] EMIR instrument DTU & CSU Electronics and Control in cryogenics (2005-2015)
[UK ATC/ESO] VISTA Telescope M2 Unit (2002-2006)
[GTC] M2 Drive System. Hexapod and Tip-tilt mechanism (2000-2005)
[ESA] ARIEL: M2 Mirror Cryogenic Mechanism (2019 -)

[MICINN/ROSCOSMOS] WSO: Far UV Front End Electronics (2018 -)

[ESA] JUICE: Medium Gain Antenna, Magnetometer Boom and JANUS/GALA Instruments Electronics (2016 - 2020)

[ESA] SOLAR ORBITER: Antennas & Instruments Subsystems, Booms, EPD/SO-PHI (2010 - 2018)

Particle Physics:

[ALBA] X-Ray Mirror Bender with nanometre correction (2014 - 2018)

[CIEMAT] Participation in the design and supply of the L3 experiment for LEP (CERN)

[ESS Bilbao] Studies for ESS preparatory phase and auxiliary equipment (2006-12)

Fusion:

[F4E] Centrifuge Accelerator for JT60SA Pellet Launching System (2022 -)

[F4E/IO] Micromechanical analysis for the Pre-compression Rings (2012 - 2019)

[F4E] Engineering works of the TB08. ITER Site Infrastructure works.

[EFDA/ITER] Remote Handling design studies: Cassette Toroidal Mover (2000-2005)

R&D PROJECTS

[CDTI/ MISIONES] Fusion Future. Remote Handling and diagnostics systems (2020 -)

[INTERNAL FUNDING] Ground Telescopes Mirror Cells actuating systems (2018 -)

[INTERNAL FUNDING] X-Ray mirror Bender detailed design and prototype (2015-2016)

[CDTi/INTERNAL FUNDING] FUSKITE: Tritium recovery experiment Testing (2011-2015)

[FP7] European Solar Telescope M2 Drive System (2007-2010)

MARKETS

Nuclear / Defense / Aeronautics / Space

QUALITY CERTIFICATIONS, NUCLEAR QUALIFICATIONS

ISO 9001 / ISO 14001

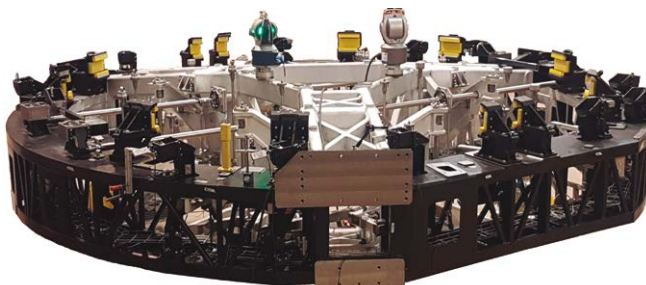

ELT M2 Cell

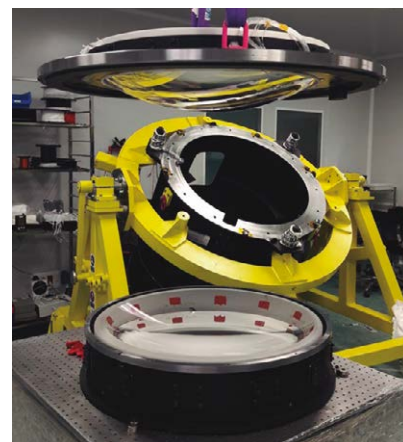

WHT WEAVE Optical Corrector System Integration



SENER

Aeroespacial

COMPANY NAME	SENER RYMSA RF, S.L.
ADDRESS	Carretera de Campo Real Km. 2,100, 28500 Arganda del Rey, Madrid
WEB	www.aeroespacial.sener
TURNOVER	6M in year 2021
EMPLOYEES	53 in year 2021
SME	YES
CONTACT PERSON	Juan Carlos García-Taheño
	POSITION Business Development
	PHONE +34.91.867.07.09
	EMAIL juancarlos.garcia@aeroespacial.sener

COMPANY ACTIVITIES AND SKILLS

Since 1974, SENER RYMSA RF (a SENER AEROESPACIAL S.A. company) specializes its activity in the design, manufacturing and commercializing of antennas and RF passive components, based on the use of coaxial or waveguide techniques, for several applications on the scientific, defense, air traffic control and broadcasting business areas, providing customized and turkey solutions and services for customers an all five continents.

This experience has been strongly developed over the years leading us to today's market leadership position, with capabilities to manage each project from conceptual design, through manufacturing to on-site installation and commissioning.

Principal products and solutions: complex RF systems for industrial and scientific applications (as particle accelerators or fusion laboratories) customized to the requested environment, RF components and accessories, complete radiating system (SSR and PSR antennas and pedestals) for primary and secondary air traffic control radars, complex custom-made broadcasting antenna systems, filters and channel combiners for broadcasting purposes and turnkey broadcasting system solutions. Bases its high-value-added competitive position on the control of key technology in the markets in which it operates, allowing it to meet the needs of its customers in an innovative, flexible, and cost-efficient way.

Within the scientific business area, SENER RYMSA RF designs and produces equipment for large scientific facilities, such as particle accelerators or fusion laboratories, offering a complete high-technology radiofrequency and electrical product portfolio covering all needs both at the level of intake power as well as at working frequency level, including all kinds of accessories. All products are qualified to work under both normal pressurization, vacuum conditions and cryogenic or radioactive environments. SENER RYMSA RF's organizational structure, 100% focused in engineering is optimal for adapting the final characteristics to the specific needs of each project, allowing a rapid and reliable response to the specific requirements of each client.

LARGE SCIENTIFIC FACILITIES AND NATIONAL RESEARCH FACILITIES CONTRACTS

[ESS-ERIC; CERN; ESS Bilbao; FAIR; GSI; DIAMOND] Supply of coaxial transmission lines and accessories, adapters and measurement couplers in sizes between 1 5/8" and 6 1/8" (2017-2021)

[FAIR] Supply of waveguide WR2300 elbows and accessories, (2019)

[ESS Bilbao & ESS-ERIC] Design and Supply of waveguide components for RF distribution networks of RFQ and DTL cavities (2018)

[CERN] Manufacturing, Integration and Cabling of Output Filters and High Frequency (HF) Transformers for converter R2E-LHC (2017)

[CERN] Several supplies of waveguide and coaxial transmission line components (2017/2018)

[ALBA-CELLS Synchrotron] Supply of a WATRAX waveguide to coaxial adapter, to connect the RF power source to Storage Ring and Booster cavities of ALBA (2017)

[ITER Organization] Supply of several junction boxes for electrical and control cables in hazard environment (2016).

R&D PROJECTS

[CDTI - CIEN] Accelerators and associated technologies for large research infrastructures (2016): Design of an advanced low loss high RF power combiner based in a resonant cavity. The combiner will allow adding more than 100 high power RF inputs in one output reducing the insertion losses and maximizing the efficiency beyond the current limits.

[CDTI - MISIONES] Industrial research in technologies and applied processes for IFMIF-DONES, oriented to the fusión programme DONES-EVO (2021): Design of advanced power couplers, test box, flexible RF transmission line, T-stub and several components to build a combiner based on a resonant cavity, beyond the current limits.

MARKETS

Nuclear / Defense / Naval / Aeronautics / Related to antennas and passive RF components

QUALITY CERTIFICATIONS, NUCLEAR QUALIFICATIONS

ISO 9001 / ISO-45001 / Efer 1000-1; ed. 5.



ESS ERIC RF Transmission Line Installation



Manufacturing Premises for RF Waveguide Manufacturing

COMPANY NAME	SGENIA INDUSTRIAL
ADDRESS	Avda. Zumalakarregi, 48 48006 BILBAO
WEB	www.sgenia.com
TURNOVER	1 M€ in year 2021
EMPLOYEES	10 in year 2021
SME	YES
CONTACT PERSON	Jesús Lama
	POSITION CEO
	PHONE 916306388
	EMAIL sgenia@sgenia.com

COMPANY ACTIVITIES AND SKILLS

SGENIA INDUSTRIAL is a company specialized in the engineering and manufacturing of products and components in different activity areas like Energy, Aerospace and Defence and Industrial. In all these sectors different fields are worked. SGENIA INDUSTRIAL develops promotes and executes industrial "based-on-technology" projects and works for large European scientific facilities (ITER, ESA,...) and it is also involved in international partnerships together strongest European research centers and University.

SGENIA INDUSTRIAL designs, manufactures and tests robotic equipment. Sgenia has capability of full mechanical and electronic design, as well as it develops and integrates embedded sensors on robots. Extreme conditions robots have been manufactured for nuclear and military environment. Sgenia develops the control systems and our software department has experience in developing rich graphical interfaces, high quality visualization and augmented reality to assist the monitoring of the robots.

Engineering Capabilities: 1) Thermal, Mechanical and Electrical design of components, devices and equipment, 2) Engineering for ultra and high vacuum, cryogenic and special gasses installation, 3) Pressure equipment services: modelling, design and manufacturing,

Manufacturing capabilities: 1) High accuracy machining of metallic and ceramics components, 2) Specials alloys and materials (Inconel, tungsten, ceramics,...), 3) TIG, Brazing, EBW and Laser welding under UHV conditions, 4) Vacuum services: outgassing test and leakage detection in UHV conditions

Advanced software development: 1) Advanced algorithms (machine learning, tomography algorithms,...), 2) Advanced visualization (3D engineering), 3) Sensor design and integration

LARGE SCIENTIFIC FACILITIES AND NATIONAL RESEARCH FACILITIES CONTRACTS

[ITER] ITER Manufacture Connection Assembly for CER TF-19 (2021). Manufacturing, inspection and test procedures for the supply of the mechanical connection assembly for the CER-TF19 components for ITER Continuous External Rogowski diagnostics.

[F4E] ITER Supply of 450 Mechanical Platforms for Diagnostics Magnetic IVCs F4E-

OPE-0852 (2018-2020). The purpose of these platforms is to provide mechanical support, protection and electrical connectivity for the sensors, which incorporate diagnostics sensors.

[ESA] ESA Plasma Bridge Neutralizer based on Radio-Frequency (2017-2018). development of a cathode less RF-neutralizer, RF-PBN, based on an inductive coupled RF-plasma discharge neutralizing element.

[ITER] ITER Continuous External Rogowsky Coils (2015-2017). Supply of 6 CER coils, a sensor designed to measure current from 0 to 20MA with a cut-off frequency of 100 Hz, to be installed on a large steel structure housing the main magnets of the ITER tokamak and enclosing the ITER plasma and vacuum vessel

[ITER] E006 ITER Diagnosis Pressure Gates SG01, SG02, SG03 (2012). Design and optimization of Diagnosis Pressures Gate (DPGs) for the main vacuum vessel of the ITER.

MARKETS

Nuclear / Defense / Space / Energy / Biomedical

QUALITY CERTIFICATIONS, NUCLEAR QUALIFICATIONS

ISO 9001 / ISO 14001

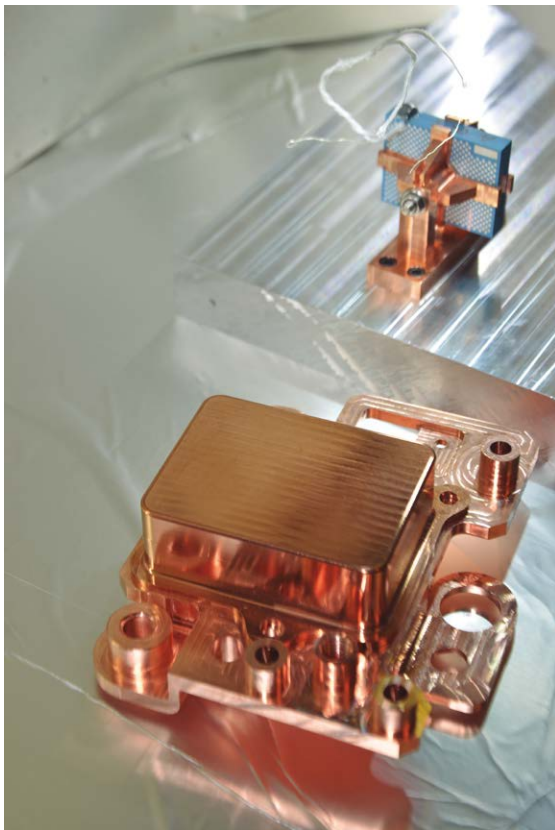

Mechanical Platforms for Diagnostics Magnetic (ITER)



Inspection of mechanical Platforms for Diagnostics Magnetic (ITER)



COMPANY NAME	SOGELAIR AEROSPACE, S.A.
ADDRESS	C/ Francisco Gasco Santillán, 2B, 28906 Getafe
WEB	www.sogclair.com
TURNOVER	4,7 M€ in year 2021
EMPLOYEES	60 in year 2021
SME	YES
CONTACT PERSON	Armando Gutiérrez García
	POSITION Business Manager
	PHONE +34 627.909.271
	EMAIL a.gutierrez@sogclairaerospace.com

COMPANY ACTIVITIES AND SKILLS

SOGELAIR is an international leader in the design, manufacturing and integration of high added value solutions in the fields of aeronautics, space, science installations, civil and military transportation systems.

We are located in Spain, France, Germany, UK, North America and Tunisia. In Spain, SOGELAIR aerospace S.A. has developed different projects in the frame of R&T and Big Science Installations applying the group quality system and policies to ensure the integrity of the project.

We are recognized experts in:

- Mechanical Design and manufacture of structures and systems, tooling for Nuclear/Energies Industry, Design and Manufacturing for pipelines and Systems Installations
- Simulation and stress analysis,
- Manufacturing engineering and support,
- Configuration management at program, engineering and industrial levels,
- Design and manufacturing of aircraft interiors,
- Design and manufacturing of onboard and simulated equipment,
- Thermoplastics,
- Additive manufacturing.
- Simulation and Training solutions

Through our technical expertise of big volume projects and our all-integrated resources SOGELAIR can present an efficient end-to-end offer to meet customer needs in Big Science Installations domain.

LARGE SCIENTIFIC FACILITIES AND NATIONAL RESEARCH FACILITIES CONTRACTS

[ITER – OBUU TECH], December 2019, IO/19/17922/DAL: Lot 7: VVTS Port Shroud Assembly Tools” (2019)

Awarded with this contract with the objective of deliver, from the design to the manufacture, and testing of 3 tools for the assembly of the upper, equatorial and lower port shroud. The main challenge of this contract is to create the most optimal design form the design-to-cost point of view to be able to deliver all the sets within a limited budget.

[ITER], 2019, Assembly Processes, Equipment and Machining Contracts supplier approval process (2019)

We were prequalified as Lead contractors for ITER Assembly Processes, Equipment and Machining Contracts Lot6 (Lifting Equipment and Related Accessories) and Lot7 (Assembly Equipment)

R&D PROJECTS

[HORIZON 2020 – Clean Sky], HYGIEIA Project (2020-2022)

The objective of the HYGIEIA project is to design and manufacture a greywater container with reduced biofilm growth, based on appropriate surface coatings. HYGIEIA evaluates two surface coating technology solutions that incorporate broad-spectrum antimicrobial materials plied through wet and dry approaches: nano-particle paints and physical vacuum coatings (PVD).

[LAB4PYMES – Comunidad de Madrid, Consejería de Ciencia, Universidades e Innovación de la Comunidad de Madrid], iceAls Project (2020-2021)

Project developed in cooperation with the Carlos_III University of Madrid. Artificial Intelligence and Neuronal networks applied to aerospace runway conditions. The technical ambition of the project is to develop a pilot test of a system based on a neural network and optical sensor technology from UC3M that will be capable of processing significant input data related to the parameters that influence the presence of ice on airports pavements, in order to carry out an automatic real-time assessment of the level of risk and classify it according to the RWYCC codes of the harmonized Runway Condition Assessment Matrix (RCAM)

[HORIZON 2020 – Clean Sky], HEFESTO Project (2018 – 2020)

The goal of the HEFESTO project has been to develop a novel multi-layer coating that effectively thermally insulates and flameproof CFRP to withstand operational conditions and fire hazards in the immediate area of a helicopter engine.

MARKETS

Nuclear / Defense / Automotive / Naval / Aeronautics / Space / Energy

QUALITY CERTIFICATIONS, NUCLEAR QUALIFICATIONS

ISO 9001 / EN-9100 extended ISO-9001 requirements for Aerospace Industry



SOGECLAIR Proyecto ITER Equatorial render



COMPANY NAME	SUPRASYS S.L.
ADDRESS	Av. Lehendakari Aguirre, 11, 7º Dpto. 7. 48014, Bilbao
WEB	www.suprasys.es
TURNOVER	130.232,62 € in year 2021
EMPLOYEES	7 in year 2021
SME	YES
CONTACT PERSON	Santiago Sanz Castillo
	POSITION Chief Technology Officer (CTO)
	PHONE +34 946 85 58 37
	EMAIL santiago.sanz@suprasys.es

COMPANY ACTIVITIES AND SKILLS

SUPRASYS is a technology-based company with wide expertise in the fields of cryogenics, vacuum and superconductivity. Its capacities are focused in the multiphysics analysis, electromagnetic systems and laboratory instrumentation and testing.

It is oriented to give support in technical challenging projects to Large Scientific Facilities, Universities, Research Institutes and Enterprises for Big Science Industry. SUPRASYS also gives support for the whole process of technological solutions development.

LARGE SCIENTIFIC FACILITIES AND NATIONAL RESEARCH FACILITIES CONTRACTS

[ITER – AVS] Electromagnetic analysis for the Charge-Exchange Recombination Spectroscopy - CXRS (2022), including In-vessel and Ex-vessel components, from PDR to FDR.

[ITER - BERTIN TECHNOLOGIES] Thermo-mechanical analysis for the DIP Active Doglegs (2022), required to ensure structural integrity under normal and accidental conditions and deformations under normal conditions as regards to the alignment requirements of the optical beams.

[IFMIF-DONES – CIEMAT] Technical support for the design and construction of superconducting solenoid for DONES (2021). Review of the design and manufacturing process of the solenoid package component, in accordance with ASME Boiler and Pressure Vessel Code.

[ITER – ALTER TECHNOLOGY] Magnetic test bench simulation (2021) Simulation of EM fields in a modified magnetic test bench

[ITER – BERTIN TECHNOLOGIES] EM loads assessment for 55.FA Active Dog Legs (2021). Detailed analysis of the EM forces applied on the mirror mounts of the active doglegs of the Density Interferometer Polarimeter (DIP) during the plasma operation and disruption.

[University of Granada] Customized cryogenic pump (2021). Manufacturing, design and supply of a customized cryogenic pump for the Penning line of Ion Traps and Lasers Laboratory.

[CIEMAT] Technical support for the assembly process for the MCBXF magnet (2019-2020). Technical support (in assembly and manufacturing of tooling) for the manufacturing of an orbit corrector prototype for the “HiLumi HL-LHC”.

[UKAEA] Superconducting magnet feasibility study (2018). Analysis of the superconducting magnet feasibility for a large-scale fusion test bench: MTF (Module Test Facility), renamed as CHIMERA.

[STFC - ANTEC] Technical support for the modifications in a dipole for CLARA linear accelerator, ANTEC (2018) Calculation and evaluation of a design modification in a dipole for the linear accelerator CLARA (Daresbury, UK).

[University of Malaga - The Vacuum Projects] Technical support for the development of a Mars atmosphere simulation chamber (2018). Thermal and structural analysis, supporting in the definition of some critical components.

[CERN - ANTEC] Technical support for QUACO Phase II (2017). Support in detailed design, including Magnet conceptual and detailed design, Multiphysics FEM simulations including structural and EM analysis, Mock-up design and testing

R&D PROJECTS

[CDTI - Misiones] DONES-EVO, Industrial Investigation in Technologies and Processes Applied to IFMIF-DONES to Evolution in the Fusion Programme (2021-2024). The role of SUPRASYS is to perform the RF calculations and the conceptual design of the meander prototype, as part the studies to produce a secondary 40 MeV deuteron beam line.

[HAZITEK] SIMACEM, High Field Magnetic Systems for the Sample Environment (2019)

Study of the state-of-the-art and market survey of high field magnets and conceptual design of a magnet for a MOKE system.

MARKETS

Defense / Naval / Aeronautics / Space / Energy / Railways

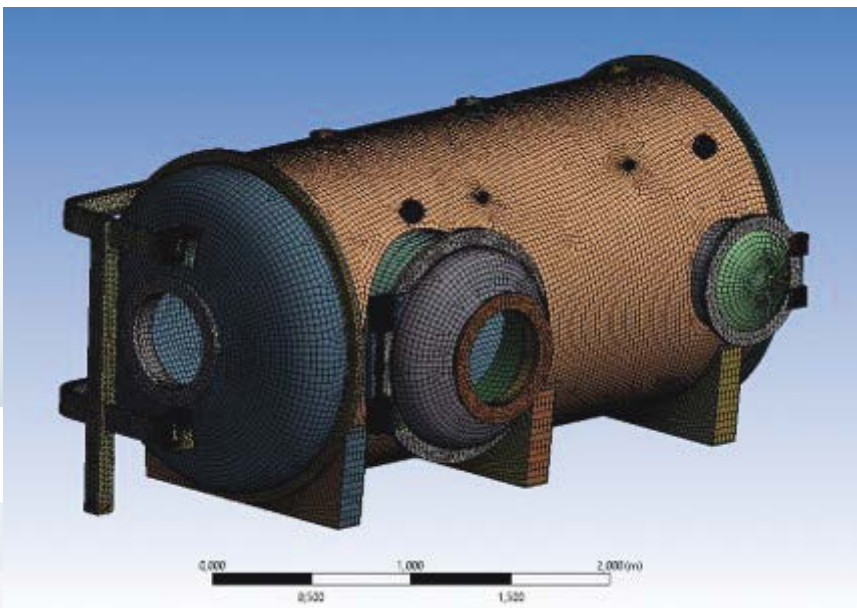

3D FEM model of a Mars atmosphere simulation chamber

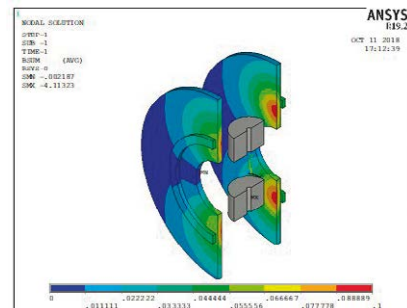

EM simulation of the transient effects on superconducting coils after rapid discharge in a magnetic test bench

COMPANY NAME	Fundación Tecnalía Research & Innovation (TECNALIA)
ADDRESS	Parque Tecnológico de Bizkaia, c/Geldo, Edificio 700, Bizkaia
WEB	www.tecnalia.com
TURNOVER	114.000.000 in year 2020
EMPLOYEES	1472 in year 2020
SME	NO
CONTACT PERSON	Hugo Martínez de Lahidalga Fernández
	POSITION Desarrollo de Negocio IdC
	PHONE +34 664 359 613
	EMAIL hugo.martinezdelahidalga@tecnalia.com

COMPANY ACTIVITIES AND SKILLS

TECNALIA (www.tecnalia.com) currently it is one of the most important private applied research centres in Spain and Europe, and offers products and technological solutions for scientific Infrastructures and Science Industry in the following areas:

- Construction and environment: support to the design of new facilities and physic infrastructure (locations selection, environmental design for the facilities, mobility impact, best environmental practices), Contribution to the civil work of singular features.
- Energy efficiency: Design and development of power electronics equipment, Control systems for power converters, and IGBT's.
- Advanced materials and processes: Development of new materials and their characterization in extreme conditions, Heat treatments and surface coatings and conservation, Welding process (brazing, soldering),.
- Control, data access, communication and remote handling: Autonomous navigation systems, Handling systems based on parallel kinematics.for Remote handling.
- Testing and certification: Electrical equipment, Assessment of materials and components behaviour against corrosion phenomena, stress, fatigue, etc., Conformity evaluation of electrical equipment, diagnosis and maintenance of equipment in facilities and supplier qualification, Chemical/metallurgical/mechanical characterization, NDT (Non Destructive Test) and special test.

LARGE SCIENTIFIC FACILITIES AND NATIONAL RESEARCH FACILITIES CONTRACTS

[ITER] IO/21/OT/19477/ADC IVC Electrical Insulating Breaks Qualification and Production (2021)

[F4E] F4E-OPE-0893-01 Proof-of-principles testing of First Wall Tile Repair Techniques (2018)

[F4E] F4E-OPE-089-01 Application of an alumina coating on sections of pipes to be used in the Blanket Cooling Manifold System. (2018)

[F4E] F4E-OMF-0795-01 Supply of the beam line components composed of the Neu-

tralisier and Electron Dump (“NED”), the Electrostatic Residual Ion Dump (“ERID”), the Calorimeter, and the Component Common Equipment (“CCE”) for the MITICA experiment (2017)

[F4E] F4E-OFC-618 Provision of destructive and non-destructive testing of materials at room and elevated temperatures. (2016)

[CERN] IT-4191/TE/HL-LHC Quadrupole Corrector First-of-a-kind for HL-LHC (QUACO Pre-commercial Procurement). (2016)

MARKETS

Defense /Automotive / Aeronautics / Space / Energy

QUALITY CERTIFICATIONS, NUCLEAR QUALIFICATIONS

ISO 9001 / ISO 14001 / UNE-EN 9100 Aerospace Certification



Vacuum tank in the laboratory for advanced surfaces

COMPANY NAME	TECNATOM, S.A.
ADDRESS	Avda. Montes de Oca, 1, 28703 San Sebastián de los Reyes, Madrid
WEB	www.tecnatom.es
TURNOVER	107.053.166 € in year 2021
EMPLOYEES	707 in year 2021
SME	NO
CONTACT PERSON	María Del Carmen Pérez Melguizo
	POSITION R&D PROJECTS
	PHONE (+34) 916598659
	EMAIL cperez@tecnatom.es

COMPANY ACTIVITIES AND SKILLS

Tecnatom was set up in 1957 as a Spanish engineering company specialized in guaranteeing the operation and maintenance of nuclear power plants to the highest levels of safety. The company supplies services and products with a high technological content, frequently designed and developed in-house, tailored to the needs and requirements of different clients and markets, in the following areas: Inspection Services, Training, Long-term Operation, Operation Support, Simulation Services, Control Rooms, Fuel Inspection, Component Engineering, Testing Service, Emergency Management, Decommissioning and Plant operation. Nowadays, Tecnatom is an international business group with subsidiaries in USA, France, China, Brazil and Mexico, carrying out project in more than 40 countries worldwide.

Tecnatom has been involved in the European Fusion programme (specially in ITER) providing support in the field of Non Destructive Testing, Remote Handling, Robotics activities, Nuclear Safety and Simulation of processes.

LARGE SCIENTIFIC FACILITIES AND NATIONAL RESEARCH FACILITIES CONTRACTS

[ITER - FBL] Development of a robotic inspection cell and the ultrasonic inspection procedures for the inspection of HIP joints in FWP (2021)

[ITER – ENSA] Development of ultrasonic inspection procedures and mechanical scanners for the inspection of welds during vacuum vessel assembly (2021)

[ITER] Analysis of Phased Array Ultrasonic Testing Data of Welded Joints for Vacuum Vessel Sector (IO/CT/19/4300002015) (2019)

[ITER] Structural Design Criteria for the Lip Welded Seals refinement and validation (IO/CT/19/430000xxxx) (under signature) (2020)

[DEMO – CIEMAT] Development of ultrasonic and visual testing inspection procedures for DEMO, WPRM-AWP2015-RM-5-1-3-T001 NDT technology development (2016).

[F4E - LEADING ENTERPRISES] First wall panels: Development of inspection techniques. Inspection of elements of the first prototype

[F4E] Multiple Framework Supply contract in cascade (F4E-OMF-383-02) (2015)

[ITER] Framework services contract: Remote Handling Maintenance Engineering Services (IO/15/CT/6000000169) (2015)

[F4E – SIMIC S.p.A.] Development of ultrasonic inspection procedures and manual guided scanners for the inspection of Toroidal Field Coil cases welds, F4E-OPE-414: Supply of the ITER TF COIL Cold test and Coil Insertion

[F4E - Ansaldo Nucleare-Mangiarotti-Walter Tosto] Development of ultrasonic inspection procedures and manual guided scanners for the inspection of ITER Vacuum Vessel welds, F4E-2010-OPE-068: Supply of seven vacuum vessel sectors (2010)

[ITER - ENSA] Development of manual guided scanners for ultrasonic inspection of welds for ITER vacuum vessel assembly of sectors and ports, ITER/12/4300000724 (2012).

[F4E – EADS Casa Espacio] Development of ultrasonic inspection procedures for the inspection of precompression rings, ITER-F4E-OPE-345)

[ITER NBI - CIEMAT]: RH Studies and interfaces (2007-2008)

[ITER] Workshop on Safety Culture Campaign – External communication on safety related topics (2014).

[ITER] Workshop on implications of presentation of safety related issues in publications and conferences (2014).

[ITER] Safety Culture Survey of the ITER Organization, IO/CT/4300000993, (2013).

[CIEMAT] Development of UT Inspection techniques to assess the integrity of Divertor Joints.

[ITER - IBERINCO] Feasibility study of automatic inspection of ITER Vacuum Vessel welds (TW6-TVV-HPRIB)

[CIEMAT] Analyze & design the feasibility of the components maintenance of the neutral beam injector.

R&D PROJECTS

- Advanced manufacturing technology for science industry. Application in the field of fusion (FUSION TECHNOLOGIES). National research project, funded by CDTI. EXP 00081275 / IDI-20151084.

MARKETS

Nuclear / Defense / Aeronautics / Space / Energy / Oil & gas

QUALITY CERTIFICATIONS, NUCLEAR QUALIFICATIONS

ASME / RCC-MR / ISO 9001 / ISO 14001 / CEFRI / ISO 17025, INPO, EPRI



UT inspection of First Wall Pannels prototypes (ITER)

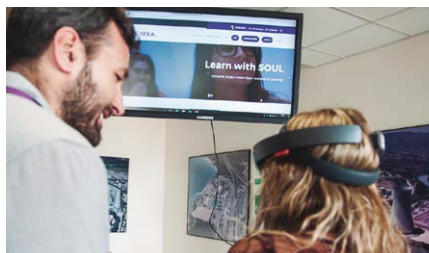

SOUL Knowledge management and learning platform



CMT Power Plants Monitoring Centre

COMPANY NAME

TECNOBIT SLU

ADDRESS

C/ Marie Curie 19, 28521 Rivas-Vaciamadrid (Madrid) Spain

WEB

grupooesia.com

TURNOVER

60.650.628,46 € in year 2020

EMPLOYEES

1400 in year 2020

SME

NO

CONTACT PERSON**David García Boyero****POSITION** Airborne systems Business Unit**PHONE** 0034 669 86 45 85**EMAIL** dgarciabo@oesia.com

COMPANY ACTIVITIES AND SKILLS

Tecnobit is the engineering company of Oesía Group. Its constant innovative effort has made it a clear international reference in Communications, Security and Defence.

Tecnobit supplies the main countries of the world the most advanced developments in Avionics, Optronics, Tactics and Secure Communications, Simulation and inhibitors.

Tecnobit solvency has enabled it to provide components to 1 out of 3 new transport aircraft built in the world, participate in the Eurofighter program, build the largest simulation center in Latin America or develop the world's safest mobile phone (with accreditation of international institutions like NATO).

Rivas corporate headquarters (Madrid) and the emblematic plant in Valdepeñas (Ciudad Real) are the international operations centers of Tecnobit.

LARGE SCIENTIFIC FACILITIES AND NATIONAL RESEARCH FACILITIES CONTRACTS

[JAL] LINPRO evolution program(C4I) (2022)

[INTA] Support for National benchmark for a certifiable POC-SM, TECNOESPRES8 (Aeronautic y Space) (2021)

[JAL] LINPRO LINK 22 capabilities for frigates class F-100 (C4I) (2021)

[INTA] POC-SM tecnoespres7 certification (Aeronautic y Espacio) (2020)

[DGAM] Technological demonstrator design, manufacturing and operational testing for an IRST system for the F110 (IRST F110, MC121504 Program). (C4I) (2020)

[JAL] LINPRO TDL capabilities for secure modes and RE. (C4I) (2020)

[DGAM] STAC-IS and TSVCIS voice communication secure modes on the portable crypto-devices (C4I) (2019)

R&D PROJECTS

[INTERNAL] Airworthy National crypto computer (CNE) (2020)

[INTERNAL] IRST (2020)

[CDTI] PRESENCE (2015/2020)

[INTERNAL] SpainSAT (2016/2020)

[INTERNAL] Onboard computer (2016/2020)

[INTERNAL] ICU / PSU especial (2016/2020)

[INTERNAL] Computer integrated displays (2016 / 2020)

[INTERNAL] CASTOR (2016/2020)

[INTERNAL] DISPLAYS COCKPIT AERONAVES (2016/2020)

[INTERNAL] ORIZON AND LEDA optronic modules (2016)

MARKETS

Defense / Automotive / Naval / Aeronautics / Space / Energy

QUALITY CERTIFICATIONS, NUCLEAR QUALIFICATIONS

ISO 9001 / ISO 14001



AIRBUS A400-M AMS



Eurofighter_FLIR

COMPANY NAME	TEKNIKER
ADDRESS	C/ Iñaki Goenaga 5. 20600 Eibar, Gipuzkoa
WEB	www.tekniker.es
TURNOVER	23,88 M€ in year 2021
EMPLOYEES	283 in year 2021
SME	R&D Center
CONTACT PERSON	Luis Uriarte Ibarrola
	POSITION General Manager
	PHONE 648 12 27 84
	EMAIL luis.uriarte@tekniker.es

COMPANY ACTIVITIES AND SKILLS

TEKNIKER is a technological centre with almost 300 highly trained of which 20% hold a PhD degree people in its personnel, 50% show MsC, engineering or equivalent long-course degrees, being the rest technicians. Its mission is to help industry sector to increase its innovative capacity by means of generating and applying technology and knowledge to compete. TEKNIKER likes to define itself as a Technological partner in Mechatronics and Manufacturing Technologies centre.

TEKNIKER mainly specialises in the following six areas: 1) Design and manufacturing of Advanced Mechatronic Products. 2) Remote Handling, Control and Automation. Advanced calculations, simulations, design, development, manufacture, and integration of tailor-made remote applications in challenging environments. 3) Vacuum expertise: design, development, manufacture, and integration of tailor-made high and ultra-high vacuum solutions. 4) Multi-functional surfaces: design, and development of ad-hoc surfaces and functional coatings for different applications: reduce friction and wear, EM shielding, reduce H₂ permeation, protection against radiation, antireflective coatings, optical filters. 5) Inspection and Measurement: Precision engineering and metrology expertise from the micro-nano to the large scale for the development of industrial applications with challenging requirements. 6) Process knowledge on a wide range of Manufacturing Technologies. All this is offered as a industrial-scale solution to the customer.

LARGE SCIENTIFIC FACILITIES AND NATIONAL RESEARCH FACILITIES CONTRACTS

[IFMIF-DONES] UGR/2021/0135 (LCSP 2017) ERDF-Supply of Manufacture including Design, Construction, Integration, Commissioning and Handover of MuVacAS experimental station (2022).

[ESS] NBW HTT Remote Handling System – Concept of Operatio (2021). Remote Clamp UHV. Test stand and Accessories (2020-2021). Lifting & Handling for 660kVA Modulator (2019).

[ESS Bilbao – Aernnova] Neutron Chopper (2021-2022).

[F4E-ITER - Asturfeito] Electric and Control System for a Tower System (2022).

[F4E-ITER - Sgenia] 55AJ00-MHF- RK3S8P SENSOR COVER AJ-I, 55AJ00-MHF- JFB-Y5B SENSOR COVER AJ-II (2022-2022).

[F4E-ITER] Divertor, Multilink inspection tool (2018-2019).

[ILL] XtremeD monochromator shielding (2020-2021).

[ESO/ELT – Asturfeito] M1 Segment Crane electrical and control system development (2022-2023). Servo control analysis of M1 Crane (2019).

[GMTO] Enclosure Device Control System: Control, Field Bus and Device Layers (2021).

[LSST– Empresarios Agrupados] LSST Global Safety Interlock Systems Design, Control and safety systems (2015-2020).

[DKIST – Idom] Dimensional commissioning of the “dome” sub-component (2015).

[ESA] Euro Material Ageing Opportunity (2021-2025). Micro-pump for ball bearing liquid re-lubrication (2022-2024). HISRU, Photoelectrochemical system for CO₂ reduction to produce fuels and sewage treatment (2022-2023). HORACE, Triboelectric energy harvesting for Mars exploration (2021-2022). In-orbit surface metrology for deployable reflectors (2020-2022).

R&D PROJECTS

LINAC-7: Technologies for the development of compact particle accelerators. (Basque Government / ELKARTEK-2018-20).

IKERTU: Linear compact particle accelerator. (Basque Government / HAZITEK-2018-21).

NIZE: Neutron science research equipment (Basque Government / HAZITEK-2018-19).

NanCEL: Interferometric measurement in vacuum (Uncertainty of 10 nm/m) (Basque Government / Plan de Reactivación Económica -2016-17).

MARKETS

Nuclear/ Defense / Automotive / Aeronautics / Space / Energy

QUALITY CERTIFICATIONS, NUCLEAR QUALIFICATIONS

ISO 9001/ ISO 14001



Remote Clamp (ESS) vacuum + remote handling



View of Large Scale Synoptic Telescope

COMPANY NAME	TEKNOSERVICE S.L.
ADDRESS	Avda. Albaida 1, Pl. PIBO Bollullos de la Mitación (Sevilla), Spain
WEB	www.teknoservice.es
TURNOVER	20.8 M€ in year 2021
EMPLOYEES	104 in year 2021
SME	YES
CONTACT PERSON	Alejandro González Iglesias
	POSITION R&D Manager
	PHONE +34 689 611 488
	EMAIL alejandro.gonzalez@teknoservice.es

COMPANY ACTIVITIES AND SKILLS

Teknoservice is a 100% Spanish owned company with more than 30 years of experience in the new technologies sector. We provide comprehensive solutions while taking great care to ensure the quality and excellence of our services. Under our TTL brand, we use cutting edge technology to produce a wide range of professional desktop computers, laptops, tablets, workstations, servers, and massive storage enclosures. Our products are constantly monitored and updated by the engineering and networking laboratory, which manages the R&D projects. Every single one of our products is tested thoughtfully during at least 8 hours. Our broad IT solutions portfolio includes our own developed tailored operating system TTLOS and desktop & applications virtualization TTLVD.

Teknoservice is the only Spanish CERN supplier for servers, massive storage systems, high performance desktop PCs, and the only one provider of NUCs computers for CERN to date.

Teknoservice has multiple certifications guarantying its compromise. We developed a work methodology that distinguish us from others, offering an unprecedented level of personalization while covering all the requisites of our clients. This work model gives to Teknoservice a very high level of loyalty from its clients.

As an example of our commitment with research community, we signed a contract with CIE-MAT and Seville University at the end of 2019 (see R&D Projects). In the last two years, we have also implemented with success our software solutions TTLVD and TTLOS in some strategic customers like SAS (Andalusian Health Care Public Company), Granada City Council or Historical Public Consultory.

LARGE SCIENTIFIC FACILITIES AND NATIONAL RESEARCH FACILITIES CONTRACTS

[CERN] IT-4584/IT > 1000 27" and 32" monitors (2021)

[CERN] IT-4584/IT 400 Ultracompact high performance NUC Computers (2020)

[AGQ TECHNOLOGICAL CORPORATE] Several contracts of Computers, Laptops, Monitors and Storage Components (2019 - present)

[CERN] DO-30931/IT 340 Ultracompact high performance NUC Computers (2018)

[CERN] IT-4350/IT 92 (23 quad) CPU Servers for Physics Data Processing (2017)

[CERN] IT-4299-IT 1000 High Performance Computers (2017)

[ALTER TECHNOLOGY] Several contracts of Computers, Laptops, Monitors, Switches, SAs, Storage Arrays, and Servers (2013 - present)

[CENTRO NACIONAL DE ACELERADORES] Computers, Laptops, Monitors, Servers, Storage, Virtualization Infrastructure and Services (2013 - present)

[CSIC] Several contracts of Computers, Monitors, Tablets, Audiovisual Systems, Storage Arrays, and Servers (2011 - present)

R&D PROJECTS

TTL0S: is a GNU/Linux based system tailored to our clients' needs with a focus on embedded devices and thin clients. It is extremely lightweight and modular and features a complete ecosystem. This Operating System is not based under any other Linux Distribution, is working on more than 40.000 machines used by the biggest public and private companies in our country. This project was proposed to participate in CERN's OpenLAB. One of the main values for this product is its security: With a very low attack surface, and high frequency updates.

TTLVD: is a VDI and IaaS system inspired by the same philosophy behind our TTL O.S. project: very lightweight and highly customizable solution. Highly available from the start, agent/client less, lightweight, GPU Accelerated. As TTL O.S. every single aspect of the product is minded with security: Any communication is secured by high quality TLS encryption.

Panoramik: is a complete solution to support "good management" legislations. Capable of streaming multiple sources, 180° HD video recording and with one button operation, scheduled recordings, and plays well with the audio systems that are already in place.

IA Based Storage Failure Prediction: This project involves the Seville University and CIEMAT in a close industrial research collaboration. It predicts the failures of storage devices using artificial intelligence with enough time to replace it and avoid data loss.

MARKETS

Defense / Automotive / Aeronautics / Energy / Financial Institutions, Government and Main Public Organizations

QUALITY CERTIFICATIONS, NUCLEAR QUALIFICATIONS

ISO 9001, ISO 14001, ISO 20000-1, ISO 27001, ISO 45001, SR10, EMAS III, Epeat, Ecolabel.



Teknoservice products

COMPANY NAME	THALES ALENIA SPACE ESPAÑA, S.A.
ADDRESS	Einstein 7, 28760, Tres Cantos (SPAIN)
WEB	www.thalesaleniaspace.com
TURNOVER	95 M€ in year 2021
EMPLOYEES	400 in year 2022
SME	NO
CONTACT PERSON	Ángel Álvaro
	POSITION R&D Manager
	PHONE +34 91 807 79 77
	EMAIL angel.alvaro@thalesaleniaspace.com

COMPANY ACTIVITIES AND SKILLS

Thales Alenia Space in Spain is the leading Spanish company in space communications and the natural partner in Spain for communication payloads and Earth observation optical instruments. With 33 years of experience in the design, development and commercialization of advanced space systems and equipment, the company has contributed to more than 600 satellites, space probes and space vehicles from satellite operators and space agencies around the World, devoted to Earth observation, telecommunication, navigation, science, exploration and orbital infrastructure missions. It has delivered 4,000 equipment accumulating 200,000,000 hours of flight operations.

Investing some 10% of sales in R&D, Thales Alenia Space in Spain offers a wide range of solutions spanning the design and integration of payloads and subsystems for telecommunications, data transmission and TT&C (tracking, telemetry and command), optical observation instruments, radiofrequency equipment, data processing and digital electronics, network management systems for the ground segment, telemetry transmitters for launchers and communication systems for spaceports. The company has 2000 m² of clean room area (ISO 8) with the capacity to produce more than 250 equipment per year; an optical detection lab (ISO 5) for the integration of optical instruments; and a 600 m² and 12.5m free-height satellite AIT facility for the integration and test of large space systems.

Thales Alenia Space in Spain has a solid background in designing, manufacturing and testing critical systems for space applications devised to survive the harsh thermal and radiation environment of outer space and planetary missions. This background comprises a deep knowledge of the effects of radiation on electronic components as well as RAMS assessments for data processing and robotic systems.

LARGE SCIENTIFIC FACILITIES AND NATIONAL RESEARCH FACILITIES CONTRACTS

[NASA] CLPS TT&C transponders for NOVA-C and GRIFFIN lunar landers (2021)

[ESA] HERA TT&C subsystem for ESA contribution to the joint asteroid deviation experiment with NASA-DART mission (2020)

[NASA] VIPER communications subsystem for NASA's Lunar Rover to search for water ice on the Moon (2020)

[NASA] WFIRST TT&C Transponders for NASA's Next Generation Space Telescope (2019)

[CNES] STFO Fiber Optic infrastructure for remote access to satellite on the Guyana Launch Center (2018)

[ESA] Euclid Dark Energy Space Observatory: Data Transmission and TT&C Subsystem (2018)

[ESA - IAA] Main Electronics Unit (MEU) For the Plato Mission Instrument (2017)

[ESA] ExoMars Rover Actuator Drive Electronics (2016)

[ESA] Scalable Sensor Data Processor (SSDP) Development of a rad hard MPSoC chip for sensor data processing (2016)

[ESA] Sentinel 3 satellite Radiation Analysis Responsible (2015)

[ESA] JUICE Mission to Jupiter : Radiation and Charging Analysis for B2 phase (2015)

R&D PROJECTS

[H2020] SEPHY: Radiation Characterization of a Sàce Ethernet Physical Layer Transceiver (2018)

[H2020] VEGAS: Verification and Radiation Tests of High Capacity European FPGA (2017)

[H2020] CERBERO: Cross-layER multi-oBjective design EnviRONment for critical cyber-physical systems (2017)

[ECSEL] AQUAS: Aggregated Quality Assurance for Systems (2017)

[H2020] I3DS: Integrated 3D Sensors suite (2017)

MARKETS

Space

**QUALITY CERTIFICATIONS,
NUCLEAR QUALIFICATIONS**

ISO 9001 / ISO 14001

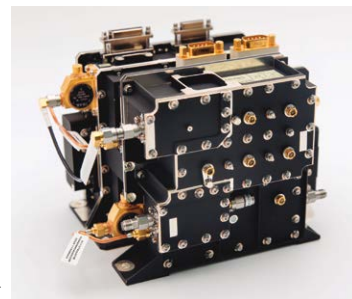

TT&C transponder

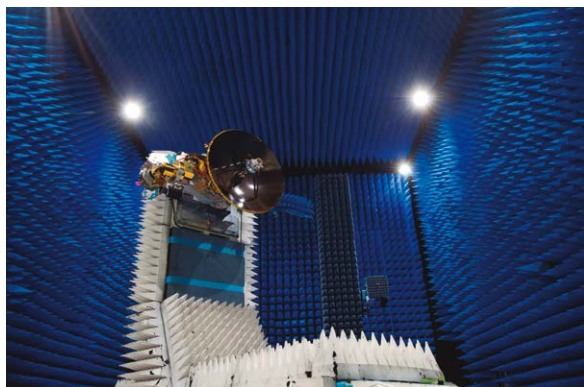

Euclid_High Gain Antenna

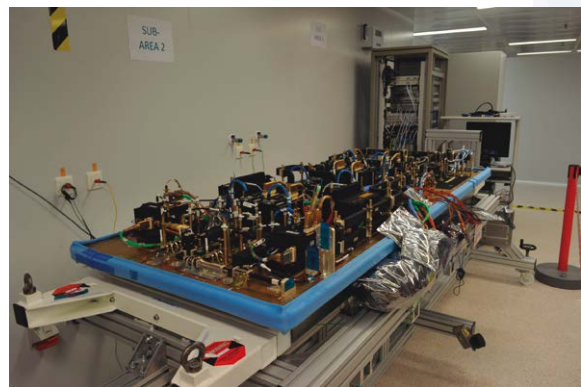

Communications subsystem

ThuneEureka

COMPANY NAME	THUNE EUREKA S.A.
ADDRESS	Rúa Pedroso, 67 36618 – Vilagarcia de Arousa (Spain)
WEB	www.thuneureka.com
TURNOVER	> 8 M€ € in year 2021
EMPLOYEES	85 in year 2022
SME	YES
CONTACT PERSON	Marina Alonso
	POSITION Sales Manager
	PHONE +34 635 565 491
	EMAIL marina.alonso@thuneureka.com

COMPANY ACTIVITIES AND SKILLS

Thune Eureka is a full service supplier of complex capital goods manufacturing. Our sections include Boilermaking, Welding, Machining, Assembly, Integration and Operational Tests.

Our competitive advantage stems from the fact that our product manufacturing encompasses the complete cycle, from the acquisition of raw materials to the delivery to the customer, including the different intermediate phases, with equipment subjected to demanding acceptance tests, and the entire process carried out by highly qualified workers.

LARGE SCIENTIFIC FACILITIES AND NATIONAL RESEARCH FACILITIES CONTRACTS

[ESS – ESS Bilbao] Shielding Collar (2022)

Carbon steel machined and coated for nuclear shielding

[ESS – ESS Bilbao] Target Shaft (2019 - 2022)

Machining, welding, assembly, vacuum and pressure testing and functional testing of the Target Shaft of ESS.

[ESS - ESSB] Connecting Pipe (2021 - 2022)

Stainless steel machined, welded, and vacuum and pressure tested.

[ILL] H1 Roof (2021 - 2021)

Carbon steel and stainless steel machined and coated for nuclear shielding.

[ESS – ESS Bilbao] (Tuning Beam Dump 2018 - 2019)

Machining, welding, vacuum and pressure testing of copper and stainless steel component.

[ESS] Vessel support and Ground Shielding (2018 - 2018)

Carbon steel machined and coated for shielding. Stainless steel machined for support.

MARKETS

Nuclear / Defense / Aeronautics / Energy / Oil & gas

QUALITY CERTIFICATIONS, NUCLEAR QUALIFICATIONS

ASME / ISO 9001 / ISO 14001 / ISO 9100 / ISO 45001 / ISO 3834-2 / ISO 1090 / NB STAMP



ESS - Target Shaft



ESS - Tuning Beam Dump



ESS - Vessel support and Ground Shielding



COMPANY NAME	TVP - THERMAL VACUUM-PROJECTS, S.L.U.
ADDRESS	Parc Empresarial Tàctica, C/ Velluters 17 - 46988 Paterna (Valencia) Spain
WEB	vacuum-projects.net
TURNOVER	1 M€ in year 2021
EMPLOYEES	10 in year 2022
SME	YES
CONTACT PERSON	Mr. Marcos Sánchez Alameda
	POSITION General Manager
	PHONE +34 961 344 831
	EMAIL msanchez@vacuum-projects.net

COMPANY ACTIVITIES AND SKILLS

TVP - Thermal Vacuum Projects is a company with wide experience in high vacuum, UHV and cryogenic technologies, specialized in design, manufacturing, assembly, testing and integration of systems, developing projects for Big Science, laboratories, space and applied vacuum.

Since its foundation in 2006, TVP has participated in projects with main National and International Research Centers such as ITER, CERN, ESO, ESA, ESRF, CEA, INTA, IAC, ALBA, CIEMAT, CSIC or CLPU, being a well-recognized company among the scientific community.

TVP has all capabilities, from design to machining, welding and testing, to deliver high quality tailored solutions. The expertise gained during years by each TVP member is shared in a creative team that makes TVP a reliable partner for developing state-of-the-art vacuum and cryogenics solutions.

LARGE SCIENTIFIC FACILITIES AND NATIONAL RESEARCH FACILITIES CONTRACTS

[CIEMAT] Dewar Chamber (2022)

[ESA-ESTEC] Swirl bench cryostat subsystem (2021)

[LPC2E-CNRS] Space exploration instrument test (2020)

[INTA] High Power Vacuum Chamber (2018)

[ESO] FIAT Vacuum Vessel (2017)

[CERN] HIE ISOLDE Diagnostic Boxes (2016)

[ALBA] Supply of Front end for experimental line 20-LOREA (Part 2 Mobile Masks) (2016)

[ESS-Bilbao] Manufacturing of three resonant cavities BUNCHER for MEBT (2016)

[IAC] Manufacturing and supply of a cryostat for Testing Infrared Detectors (2016)

[CERN] Helium Vessel Cryostat (2015)

[LPI (Uni. Valencia)] Supply, manufacturing and assembly of mechanical structure (EM), collimator (C) and passive shield (EP) for instrument MXGS of mission ASIM (2014)

[INTA] Cryostat for Testing 50kg samples to 4 K (2013)

[CIEMAT] 105 units of superconducting magnets for main lineal accelerator XFEL (2011-2015)

[ESO] Helium Lines for ALMA (2011)

[IAC] Cryostat and Optical Bench for EMIR instrument in GRANTECAN (2008-2012)

R&D PROJECTS

[IFIC UV-CSIC] Time Projection Chamber with high pressure Xe (2015)

[IFIC UV-CSIC] Development of a prototype Stripline Kicker or the Clic Damping Ring at CERN (2010)

MARKETS

Nuclear / Aeronautics / Space / Energy / Science

QUALITY CERTIFICATIONS, NUCLEAR QUALIFICATIONS

ISO 9001 / UNE 166002:2014

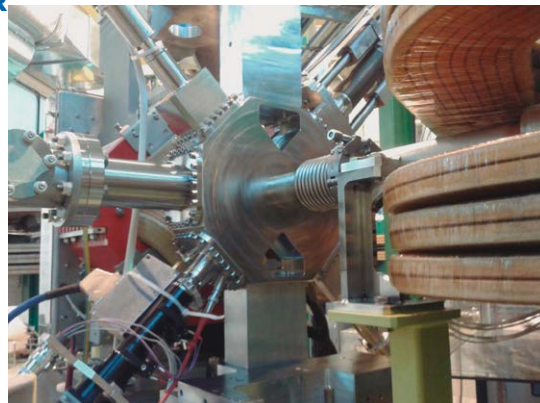

[CIEMAT] Set of superconducting magnets for main lineal accelerator of European XFEL, 2011-2015.

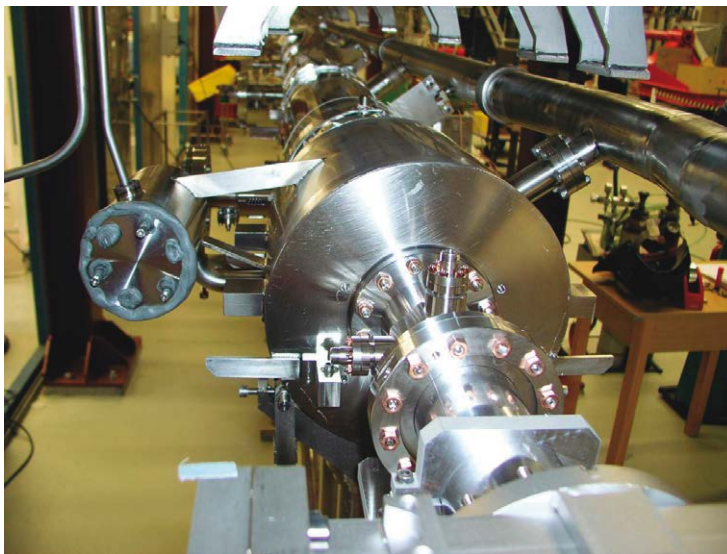

[CIEMAT] Set of superconducting magnets for main lineal accelerator of European XFEL, 2011-2015

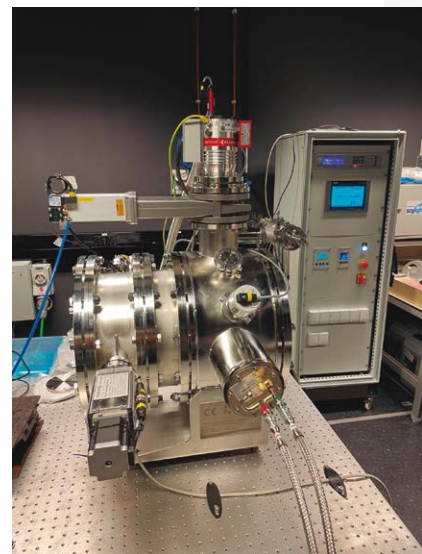

ESA-ESTEC SWIR Bench Cryostat System

COMPANY NAME	TSK ELECTRÓNICA Y ELECTRICIDAD, S.A.
ADDRESS	Ada Byron, 220 / 33203-Gijón
WEB	www.grupotsk.com
TURNOVER	615 M€ in year 2021
EMPLOYEES	1.136 in year 2021
SME	NO
CONTACT PERSON	Jaime González
	POSITION Business Development Manager
	PHONE +34 984 49 55 00
	EMAIL jaime.gonzalez@grupotsk.com

COMPANY ACTIVITIES AND SKILLS

The Services TSK provides are the design, procurement, construction, commissioning, operation and maintenance of Power Plants (both conventional, renewable energy and hybrid power plants), Electrical Substations, Power Transmission and Distributions Systems, and all kind of Industrial Facilities (cement, food, material handling, and process lines), O&G, Waste to Energy, Material Handling facilities and Environmental projects.

TSK is a pioneer in Power Generation through hybridization, with references in plants that combine photovoltaic energy with diesel and electrical storage, integrated solar combined cycles or PV + CSP + thermal energy storage + electrical energy storage. TSK is also a pioneer technology company in energy storage solutions at utilities scale with high availability and fast response.

TSK has successfully executed more than 200 EPC projects in more than 50 countries in Africa, America, Asia and Europe.

LARGE SCIENTIFIC FACILITIES AND NATIONAL RESEARCH FACILITIES CONTRACTS

[KISR] Shagaya Solar Thermal Plant (2019)

[KISR] Shagaya Photovoltaic Plant (2017)

[TSK] La Africana Solar Thermal Plant (2012)

[ESO] ALMA 17 MW Multifuel power Plant (2011)

R&D PROJETS

LEAK, New safety system for oil leakage in heat exchangers for hybrid solar power plant, IDEPA (Regional level)

ProperPhotoMile, Predicting the operational lifetime of Perovskite photovoltaic cells.

Acceleration factors in the study of stability through the application of Machine Learning. CDTI (National level)

AID4PV, Modular UAVs-based solution for decision making and diagnostic task support of photovoltaic plants using electroluminescence imaging, thermography and RGB vision cameras, electrical analysis and geovisualisation, CDTI (National level)

PHOTOASSISTED, Research in augmented and virtual reality technologies for monitoring, operation and maintenance assistance in photovoltaic plants, IDEPA (Regional level)

SISPECTION, Research into techniques for the detection, classification and monitoring of objects for inspection and security purposes in industrial facilities, IDEPA (Regional level)

PVOLTAI 4.0, Research and development of operation and maintenance technologies for the management of photovoltaic plants, CDTI (National level)

SIGMA, Rejection estimator in a collector's assembly line of a CSP plant. On-line monitoring of the mounting error, IDEPA (Regional level)

MARKETS

Energy / Oil & gas / Energy Storage / Waste to Energy and Material Handling

QUALITY CERTIFICATIONS, NUCLEAR QUALIFICATIONS

ISO 9001 / ISO 14001 / ISO 45001



Thermal Energy Storage System in Thermosolar Power Plant



ALMA Multifuel Power Plant (2011)



COMPANY NAME	TTI NORTE S.L.
ADDRESS	C/ Albert Einstein 14, 39011 Santander (Spain)
WEB	www.ttinorte.es
TURNOVER	11,5 M€ in year 2021
EMPLOYEES	80 in year 2018
SME	YES
CONTACT PERSON	Miguel Peña
	POSITION Commercial
	PHONE +34 942291212
	EMAIL mpena@ttinorte.es

COMPANY ACTIVITIES AND SKILLS

TTI is a high technology innovative company in Radiofrequency and Antennas and Ground Stations. TTI works in the technological forefronts of telecom, radio-astronomy, aerospace, defence and science sectors. TTI provides fully integrated solutions, from design to manufacture and testing.

Radio-astronomy, Deep Space Stations and Satellite Ground Stations main areas of expertise:

- Cryogenic Low Noise Amplifiers (Cryo LNAs) and Warm LNAs, providing very low noise figure, cutting edge performance, and extremely stable and high reliable products.
- Passive RF Components: Feeders, Polarisers, OMTs and Diplexers
- High power Solid State Power Amplifiers (SSPAs): modular solutions based on GaN technology, with graceful degradation, low power consumption and highly reliable.
- Laboratory Cryostats & Cryogenic Receivers: down to 4 Kelvin.
- RF electronics
- Turn key ground stations
- M&C (Monitoring & Control) Infrastructures

Particle Physics main areas of expertise:

- High-power Solid-State Power Amplifiers (SSPAs): based on GaN technology, from drivers of hundreds of Watts to finals of tens of Kilowatts, for a wide range of frequency bands.

LARGE SCIENTIFIC FACILITIES AND NATIONAL RESEARCH FACILITIES CONTRACTS

[IGN] Construction, installation, and commissioning of Satellite Laser Ranging for Yebes observatory under YDALGO project (2020-2022)

[ALBA] Driver SSPAs (2015-2021) Different supplies of narrowband SSPA drivers at 500Mhz (500W) and 3GHz (350W).

[ESA/ESOC] Frame Contract for FEC (Front-end Controller), CSMC (Central Station M&C

system) and PPIU (Power Plant Interface Unit) in ESA's Ground Stations. SEC (Site Equipment Controller) for SSA-NEO Telescopes (since 2017)

[INTA] Deployment and maintenance of FEC (Front-end Controller) and CSMC (Central Station M&C system) in INTA's Ground Stations (VIL-1/2, MSP, TRN) (since 2017)

[CERN] Driver amplifiers (Qty 312) of the new power amplifier for the SPS 200 MHz RF system (2016-2018)

[ESO] Cryogenic and warm LNAs for ALMA observatory bands 1, 5, 7 and 9 (2007-2019)

[ESA/ESOC] Ka band SSPA 100W for ESA Deep Space Stations (2017)

[MIRAC-VENTSPILS] Development, installation, tests and training of receiver systems for radio-telescopes RT-16 & RT-32 (2018)

R&D PROJECTS

[ESA] Re-design of the ESA Deep Space Antennas feed system for future Moon missions (2020)

[CDTI-INNOGLOBAL] LNAs criogénicos banda 5 para receptores del SKA (2017)

[CDTI] LOCATION – Innovative developments of low-cost high-power amplifiers for scientific installations (2015)

MARKETS

Defense / Aeronautics / Space

SSPA100W at 34GHz

QUALITY CERTIFICATIONS, NUCLEAR QUALIFICATIONS

ISO 9001

Antenna Feeders

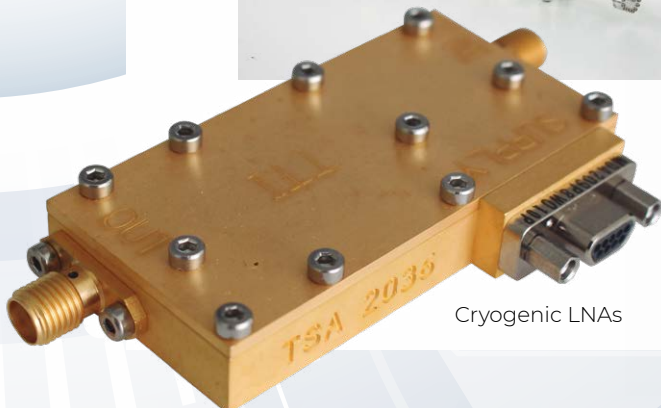

Cryogenic LNAs



Pulsed SSPA 350W at 3GHz



VAC-TRON

GLASS-To-METAL Seals

COMPANY NAME	VAC-TRON S.A.
ADDRESS	Juan de la Cierva 6, Nav. G-H, 08420 Canovelles, Spain
WEB	www.vac-tron.es
TURNOVER	2.300.000 in year 2021
EMPLOYEES	20 in year 2021
SME	YES
CONTACT PERSON	Franc Moreno
	POSITION Industrial Director
	PHONE 0034938494612
	EMAIL franc.moreno@vac-tron.es

COMPANY ACTIVITIES AND SKILLS

VAC-TRON, S.A. started its activity more than 35 years ago and is specialized developing hermetic interconnections to pass electrical signals between two hostile atmospheres. Our core technology is to fuse glass to have a hermetic seal between the electrical conductor pin and the external shell or bulkhead. This is accomplished using the technology of Glass to Metal Seals (GTMS) to produce high quality hermetic components.

This technology gives an extra of performance to your connectors:

Temperature: -195°C to 300°C

Pressure: up to 2.500 bar

Hermeticity: $< 2,69 \cdot 10^{-10} \text{Pa} \cdot \text{m}^3/\text{s}$

Dielectric Strength: 500 V -6.000 V DC

Electrical Resistivity: $> 1.000 \text{M}\Omega$

At VAC-TRON we try to understand what really needs our customer in order to offer the best solution, manufacturing bespoke Glass to Metal Seals components for a wide range of areas. Our multidisciplinary team guarantees the needs of our customers.

We have presence in many sectors as aeronautic, aerospace, automobile, gas industry, medical, military, nuclear and petroleum industry, railroad and telecommunication, manufacturing feedthroughs, relays bases, connectors, sensor & microsensor, bases and lids for filters and oscillators and pyrotechnic igniter bases. To guarantee customer requirements our Quality System is based on the requirements of EN 9100 & ISO 9001 and ISO 14001.

Our facilities include presses and a furnace to produce glass preforms, presses for the stamping of metal components, continuous belt and vacuum furnaces to produce GTMS components, and an area of surface treatments including nickel, tin and gold plating.

LARGE SCIENTIFIC FACILITIES AND NATIONAL RESEARCH FACILITIES CONTRACTS

[IO] Electrical feedthrough prototyping for irradiation test (2022)

[F4E – IDOM] Integration Design of Diagnostics Into ITER Ports (2017-2020)

[CERN] HV Feedthroughs for ToF (2017)

R&D PROJECTS

[CDTI] Nuevas tecnologías y/o metodologías para recubrir componentes con unión vidrio metal (2014)

[CDTI] Nuevos procesos de fabricación de componentes herméticos mediante tecnologías de unión vidrio metal (2017)

[F4E – IDOM] Design of a double glass barrier in a solid bulkhead (2017-2019)

[Internal] Cryogenic Feedthrough for LNG vessel (2019)

[CDTI] Desarrollo de nuevos procesos de fabricación de componentes herméticos de alta conductividad eléctrica (2021)

MARKETS

Nuclear / Defense / Automotive / Naval / Aeronautics / Space / Energy / Oil & gas

QUALITY CERTIFICATIONS, NUCLEAR QUALIFICATIONS

ISO 9001 / ISO 14001 / EN9100



3 Pins connector



Custom DN40 Flange

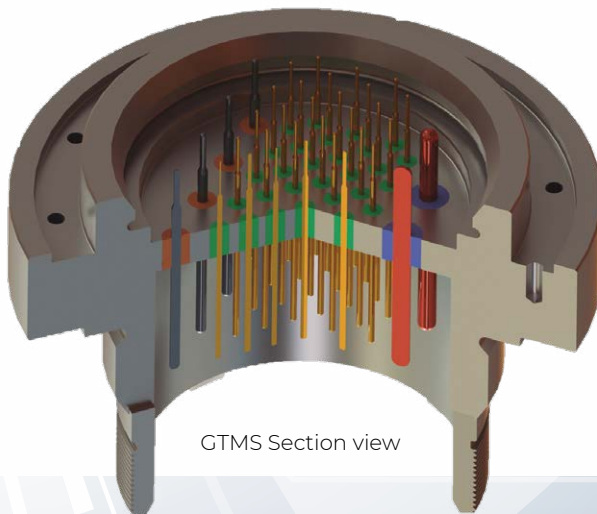

GTMS Section view



Leak Test

COMPANY NAME	VALTRIA
ADDRESS	c/ Torrent Tortuguer, 54-60, Nave 7, 08210, Barberá del Vallés (Barcelona)
WEB	www.valtria.com
TURNOVER	56.435.770 € in year 2021 (Valtria Engineering Group)
EMPLOYEES	190 in year 2022 (Valtria Engineering Group)
SME	YES
CONTACT PERSON	Enric Morlans
	POSITION Export Manager
	PHONE +34 937 379 924
	EMAIL enric.morlans@valtria.com

COMPANY ACTIVITIES AND SKILLS

Valtria designs and builds clean rooms and critical equipments for various industrial processes.

We design and execute HVAC (heating ventilation and air conditioning), clean utilities solutions for pharma, biological and high-tech, critical environments including contention and BSL levels.

Our Mission is offer quality, efficient and safe installations that meet the highest national and international standards.

Valtria has carried out about 200,000 m² of clean rooms in more than 15 countries since the last 10 years.

Valtria has got offices in Finland, France, Switzerland & Scandinavia, Algeria, Portugal, México, Chile, Argentina and Spain (Barcelona, Madrid and Bilbao)

LARGE SCIENTIFIC FACILITIES AND NATIONAL RESEARCH FACILITIES CONTRACTS

[CERN] HVAC Contract Frame (2021-2025)

[CERN] SXNS5 CMS Experimental Area P5, complete HVAC system (2022)

[CERN] High Luminosity (HiLumi) surface buildings HVAC system and underground smoke extraction (2020-2023)

[CERN] EHN Galleries Ventilation (2021)

[CERN] ECAL Laser Lab Cabins (2021)

[CERN] ATLAS Magnets & Dumps. Demineralized water cooling System (2019)

R&D PROJECTS

[SILEX Microsystems AB] New Back End HUS5 (2021) Sweden

[LEITAT Managing Technologies] Lentivirus Lab (BSL2) (2021) Spain

[MSD- Merck Serono] Reforma Virus II (BSL2) (2021) Spain

[IQM Finland OY] HVAC & Clean Utilities (2020) Quantum Computer Finland

[IDIBELL] Salas de cultivo Fase B (BSL2) (2020) Spain

[INIA-CSIC] Reforma animalario (BSL3) (2020) Spain

[IDIBELL] Reforma Estabulario (BSL2) (2020) Spain

[CNB] Módulo tratamiento de efluentes biocontaminados (BSL3) (2019) Spain

MARKETS

Nuclear / Automotive / Aeronautics / Energy / Pharma/ High Technology/Metrology/
Laser and opticals/ Nanotechnology/R&D.

QUALITY CERTIFICATIONS, NUCLEAR QUALIFICATIONS

ISO 9001 / ISO 14001 / ISO 45001



CERN. ATLAS Experimental Area. Point 1 (Entrance restricted area)



IQM Quantum Computer Center (ISO 5 Clean Room. Microelectronic)



National Biotechnology Centre (BSL level 3. Contaminant effluent containment). Madrid, Spain

COMPANY NAME	VERSE EUROPA S.L.
ADDRESS	Calle Aragon 235, 08007, Barcelona, Spain
WEB	ver-se.com
TURNOVER	600.000 EUR in year 2021
EMPLOYEES	8 in year 2022
SME	YES
CONTACT PERSON	Liliya Rybak
	POSITION Executive Director
	PHONE +34 696725846
	EMAIL liliya.rybak@ver-se.com

COMPANY ACTIVITIES AND SKILLS

VERSE is a multinational start-up focused on providing customised services to optimise the business strategy and technological solutions in the Big Science industry. Our activities are divided in two main areas: strategy consulting and engineering support.

Funded by a team of scientists and engineers with experience in the largest European and Asian scientific facilities, VERSE goal is to become the bridge between the main international research projects and the technology companies making business with them.

VERSE helps companies of all sizes, from small start-ups to large global firms, to improve their position, visibility and performance in the Big Science industry.

With more than ten international and multicultural projects in our portfolio, we provide professional support on the coordination of research teams with staff, laboratories and clients located in different countries and continents.

VERSE has already successfully coordinated the creation of eleven consortiums between technological companies in Europe and Asia: from the administrative paperwork to the integration of the teams, optimisations of resources and resolution of conflicts.

We support our clients to find business opportunities in overseas markets, work with clients and partners in a different continents and explore rising technological areas such as blockchain and artificial intelligence. We help with all the technical, administrative and legal challenges.

In our technical division, VERSE specialists provide technical support, advice and resources in many technological areas, with special focus the fields of particle accelerators and nuclear fusion technologies:

- Mechanical design and integration.
- Instrumentation and Control.
- Mission-critical systems: interlocks and safety.
- System integration, testing and commissioning.
- Operation and maintenance of particle accelerators.
- Machine learning for fusion and accelerators.

LARGE SCIENTIFIC FACILITIES AND NATIONAL RESEARCH FACILITIES CONTRACTS

[Fusion for Energy] IFMIF/LIPAC Control System Upgrade in Rokkasho, Japan (2022-2023)

[ITER] Diagnostics I&C Integration (2022-2023)

[ITER] Support for Diagnostics Design and Requirements (2022)

[KFE-Mobiis] Consulting Services on Machine Learning for Big Science (2022)

[ITER] Mechanical Engineering for Port-Plug Interfaces and In-vessel Supports (2020-2021)

[Fusion for Energy] IFMIF/LIPAC Machine Protection System Upgrade in Rokkasho, Japan (2021-2022)

[KFE-Mobiis] Consulting Services on Particle Accelerators and Fusion Technologies (2017-2023)

R&D PROJECTS

Studies on application of machine learning for the operation of particle accelerators (2022)

New technologies for mission-critical control systems for particle accelerators and fusion reactors (2017-2021)

Studies about impact of static and transient magnetic fields on COTS electronics at ITER (2021-2022)

Application of aeronautical human factor techniques to the safe operation of particle accelerators and fusion reactors (2021-2023).

MARKETS

Nuclear / Aeronautics / Space / Energy / Other Particle Accelerators

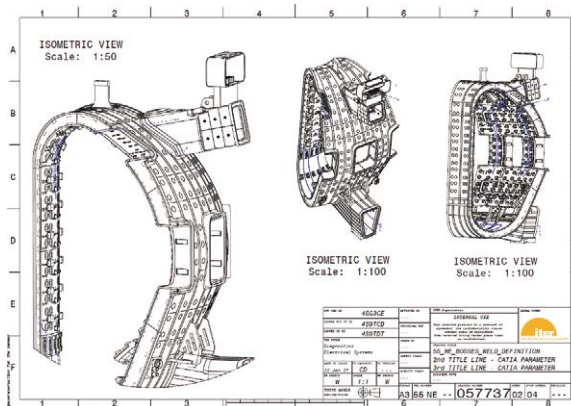

ITER Vacuum Vessel Engineering

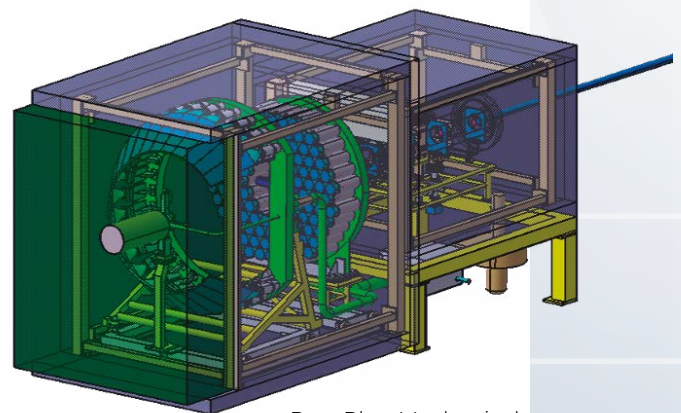

Port-Plug Mechanical Analysis and Integration





SPANISH PUBLIC RESEARCH ENTITIES





ASTRONOMY

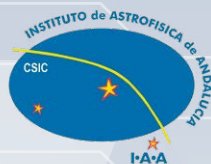

**EXCELENCIA
SEVERO
OCHOA**

HOSTING ORGANISATION
ADDRESS
WEB
CONTACT PERSON

INSTITUTO DE ASTROFISICA DE ANDALUCIA
Glorieta de la Astronomía s/n, 18008-Granada
www.iaa.es
Antonio Alberdi Odriozola
POSITION Director
PHONE +34 958 230535
EMAIL direccion.iaa@csic.es

DESCRIPTION

The IAA is a research institute that belongs to the Consejo Superior de Investigaciones Científicas (CSIC), located in Granada (Andalucía, Spain). The main activities of IAA (CSIC) are devoted to: i) carry out front-line research in the field of Astronomy and Astrophysics; ii) development of space-borne and ground-based instrumentation.

More information: <http://www.iaa.es>

MAIN EQUIPMENT OR FACILITIES

- Mechanical & electronic workshops
- Clean room for instrumentation AIV (ISO8)
- Clean room for electronics AIV (ISO8)
- Optics laboratory (ISO 8)
- Solar Physics Laboratory
- Cosmic Dust laboratory
- Operation of astronomical observatories:
 - Calar Alto Observatory (CAHA) is a joint infrastructure from CSIC and Junta de Andalucía, and the IAA (CSIC) is the reference institute. Telescopes: 3.5m, 2.2m and 1.23m.
 - Sierra Nevada Observatory (OSN) is operated by the IAA (CSIC). Telescopes: 1.5m and 0.9m.

PROJECTS UNDER DEVELOPMENT

Currently the IAA is involved in the development of the instruments: GALA/JANUS (JUICE; ESA), PLATO 2.0 (ESA) , IMaX + and SCIP (Sunrise III; NASA USA, Germany & Spain), COCA/MANIAC/Enviss/OPIC (Comet Interceptor; ESA), VenSpec/VEM (EnVision; ESA), PMI (VIGIL, ESA), SKA (SDP, SRC, PAF), TARSIS/CARMENES-PLUS (CAHA), MOSAIC/ANDES (ELT), Tunable Imaging Spectropolarimeters (EST), MIMA (OSN)

TECHNOLOGY CAPABILITIES

- Technological development of rocket-, balloon-, and space-borne astronomical payload instrumentation for science and exploration missions (including solar and planetary exploration missions), that cover many related fields like:
 - > Electronics engineering: development of power distribution units (PDU), data processing

units (DPU), mechanism controller units (MCU), electrical ground support equipment (EGSE) and on board software for instrument control using FPGAs.

> Mechanical engineering: cryo-vacuum technology, high accuracy mechanics and FEA structural analysis. This know-how has been successfully applied in projects such as CARMENES (CAHA Observatory), ALMA (Band 1) and ANDES (ESO).

> Optical design of astronomical instrumentation in visible and infrared ranges: telescopes, spectroscopy, imaging, photometry and polarimetry.

> Analysis, design, integration and verification (AIV) of astronomical instruments for interplanetary scientific space missions and stratospheric balloon observatories.

> Software development: control software development for telescopes and astronomical instrumentation; development of pipelines for processing astronomical data and data archives; Expertise in VO (Virtual Observatory) standards and services; Big Data solutions for data processing; User-friendly tools for analysis and reproducibility

- Project management More information: <http://udit.iaa.csic.es/>

SUMMARY OF RESEARCH SERVICES

- The IAA forms part of numerous consortia for the development of airborne and ground-based instruments.

- The IAA provides access to multiple and advanced observing capabilities to the astronomical community, through the CAHA and OSN observatories.

- The IAA is coordinating the Spanish participation in the Square Kilometre Array (SKA, <http://spain.skatelescope.org/>), with funds granted by a budgetary line from the Spanish Ministry of Science (2021). IAA is supporting the interaction with international consortia/groups for strategic alliances, positioning of Spanish industry, representation of Spanish groups in SKA meetings and consortia. IAA is prototyping the Spanish node of the international SKA Regional Center (SRC) network, advocating for the principles of Open Science and reproducibility.

- The IAA participates in all scientific, technological, management and communication aspects of the European Solar Telescope (EST) project.



CARMENES instrument end-to-end cryogenic development

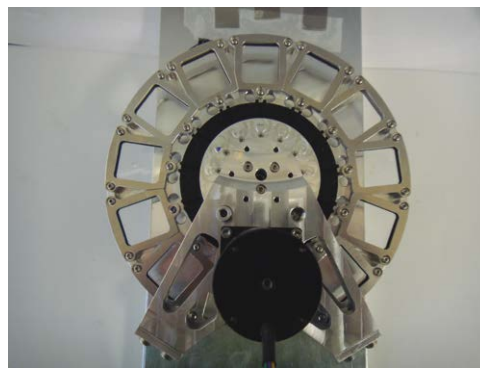

IM Janus Filter Wheel for JUICE ESA



Calar Alto

HOSTING ORGANIZATION ADDRESS

CENTRO ASTRONÓMICO HISPANO EN ANDALUCÍA
Sierra de los Filabres (POBox 11), ES-04550-Gérgal
(Almería, Spain)

WEB

www.caha.es

CONTACT PERSON

Jesús Aceituno Castro

POSITION Director

PHONE (+34) 950 632 500

EMAIL director@caha.es

DESCRIPTION

Centro Astronómico Hispano en Andalucía (CAHA) operates an optical astronomical observatory at mount Calar Alto. At 2168 m over sea level, Calar Alto Observatory hosts six research telescopes, equipped with a wide suite of state-of-the-art instruments.

Owned by the Spanish Consejo Superior de Investigaciones Científicas (CSIC) and the regional government Junta de Andalucía, Calar Alto provides data for many fields of astrophysics, for scientists from different centres and universities worldwide.

Observing time is allocated in a flexible way, in service or visitor modes, for long term and legacy projects, for granted time programs at CSIC and Junta de Andalucía, and for programs proposed by researchers at other institutions (20 % of open time).

Apart from the main scientific tasks, the facilities and the observatory's staff provide also some additional services for industrial, scientific and educational customers.

MAIN EQUIPMENT

The telescopes that currently used under direct control of CAHA are: 3.5 m reflector; 2.2 m reflector; 1.23 m reflector; 0.80 m Schmidt camera. The 3.5 and 2.2 m telescopes are locally operated in service or visitor mode. The 1.23 and 0.8 m telescopes are normally remotely operated by the users. Main instruments:

3.5 m: CARMENES VIS+NIR hi-res spectrograph, PMAS integral field spectrograph, Omega2000 prime focus IR camera, LAICA prime focus VIS imager;

2.2 m: PANIC wide-field NIR imager, CAFÉ hi-res échelle spectrograph, AstraLux VIS lucky imager, PlanetCam VIS+NIR lucky imager, CAFOS focal reducer (direct imaging, mid-res spectroscopy and polarimetry);

1.23 m: DLR CCD direct imager; 0.8 m: comercial CCD camera.

Visiting instruments are also admitted.

Two vacuum chambers for coating mirrors up to 3.5 m diameter.

INSTRUMENTS UNDER DEVELOPMENT

The most recent instrumentation in use is under a continuous process of HW and SW improvement and upgrade, specially the most complex ones: CARMENES and CAFÉ

spectrographs, PANIC NIR camera. Other instruments under development, for sky quality monitoring: NCavex extinction monitor; Excalibur multi-band advanced robotic extinction monitor; Spica all-sky low-res spectrograph.

Currently CAHA is searching for a new instrumental concepts to be developed for it flagship telescope, the 3.5m. This concept will be selected from the instrumental ideas that were presented during a science workshop for Calar Alto held at IAA-CSIC in March, 2020. Two designs were selected for the viability study phase: TARSIS and GAMAICA. The decision on which will be the instrument selected to proceed to the construction phase is expected for the Spring 2022.

TECHNOLOGY CAPABILITIES

Control electronics. Computer network design and management. Virtual machine design and management. Massive scientific data archiving. Mechanics and electronics workshops. Operation and maintenance of industrial heavy cooling and heating facilities. Heavy hydraulic systems. High vacuum. Advanced mirror coating in vacuum chambers. Instrument design, construction and operation.

SUMMARY OF RESEARCH SERVICES

Astronomical night-time observation in the optical: Direct imaging (VIS and NIR), high spatial resolution imaging (VIS and NIR), mid and high resolution spectroscopy (VIS and NIR), polarimetry and spectropolarimetry (VIS).

PROCUREMENT PROCESS

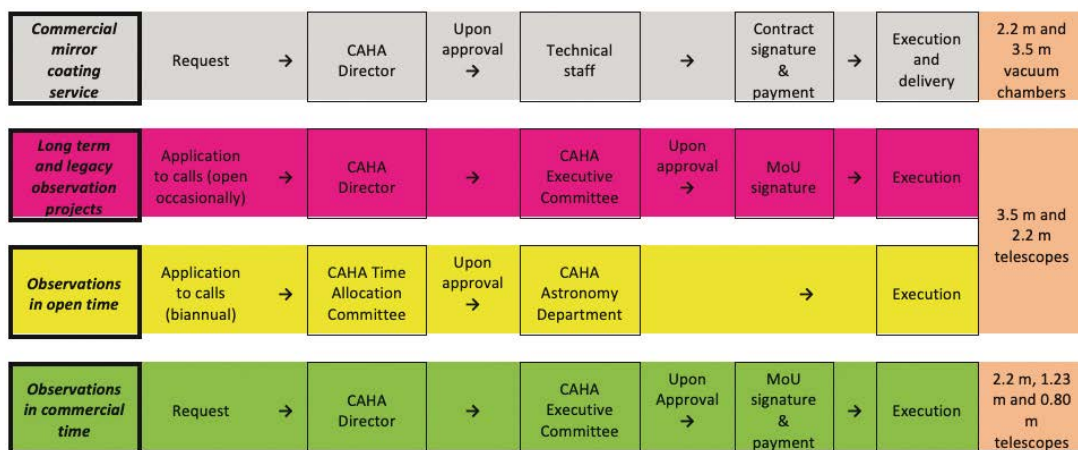

View of CAHA's greatest telescope (3.5 m aperture)

**HOSTING ORGANISATION ADDRESS**

OBSERVATORIO DE SIERRA NEVADA
Loma de Dílar. Parque Nacional de Sierra Nevada. Granada,
Spain

WEB CONTACT PERSON

www.osn.iaa.csic.es/

Maya García Comas

POSITION Director of the Observatorio de Sierra Nevada

PHONE +34 958 12 13 11

EMAIL direccion.osn@iaa.es

DESCRIPTION

The Observatorio de Sierra Nevada (OSN) is a high mountain observatory located at 2896m altitude in the Sierra Nevada National Park (Granada, Spain). It belongs to the Instituto de Astrofísica de Andalucía (IAA-CSIC), which operates and manages it. Its southernmost high-altitude location in continental Europe, together with the dry climatic conditions of Sierra Nevada, make the OSN an excellent place for carrying out, not only astronomical observations, but other experiments and studies. For this, in addition to the main building, there are secondary facilities which complete the available infrastructure.

MAIN EQUIPMENT OR FACILITIES

The OSN has a main building that shelters the living quarters and two optical telescopes with Ritchey-Chrétien configuration and two Nasmyth foci:

- 1.5 m telescope (T150), equipped with a commercial 4Mp CCD Peltier Camera
- 90 cm telescope (T90), equipped with a commercial 4Mp CCD Peltier Camera

Additionally, the smaller outbuildings house:

- SATI & MIMA, Fabry-Perot imaging interferometers measuring atmospheric airglow
- five high-sensitivity CCD cameras, monitoring the sky for meteors and fireballs
- a GPS Topo-Iberia station
- a DIMM seeing monitor
- an All-Sky Transmission Monitor, a set of four Sky Quality Meters and a TESS-4C sensor from the IAA Sky Quality Office

PROJECTS UNDER DEVELOPMENT

A technical update of the Albireo spectrometer is under way. The instrument is expected to be back in the T150 west focus by 2023.

TECHNOLOGY CAPABILITIES

The technical support and maintenance of the OSN is performed by its staff and the IAA's Instrumental and Technological Development Unit (UDIT) in different areas:

- Electronics: control of the telescopes, domes and instruments developed in-house, com-

plemented by design and development of circuits, power electronics or PCBs.

- Mechanics: development of mechanical structures, optomechanics, high precision positional systems and thermal analysis of mechanical components.
- Optics: optical design of instruments and components and regular maintenance of the telescopes' mirrors and instrument optics.
- Software: maintenance of data archives and control software for instrumentation.

SUMMARY OF RESEARCH SERVICES

OSN provides astronomical observations in the optical using the cameras at both telescopes. The OSN Time Allocation Committee (TAC) evaluates the proposals for observing time twice a year. Besides standard open time proposals, the TAC evaluates Target of Opportunity proposals, that is, unpredictable observations that need quick response. A small fraction of time is also available to be assigned by the OSN director to unexpected and urgent observations of high scientific interest (Director's Discretionary Time). There are three possible observing modes: service, remote and visitor.

OSN also provides basic maintenance of instruments and experiments hosted at OSN in collaboration with other institutions and astronomical observations for master students of external universities.

PROCUREMENT PROCESS

As part of the Instituto de Astrofísica de Andalucía, the OSN procurement process is governed by the Royal Legislative Decree 3/2011, November 14th, which approved the consolidated text of the Spanish Law of Public Sector Contracts.

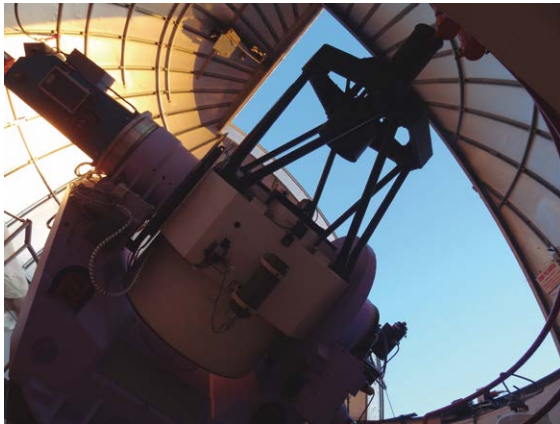

OSN Telescope T90



OSN_Telescope T150



Aerial view of the Observatorio de Sierra Nevada



HOSTING ORGANIZATION
ADDRESS
WEB
CONTACT PERSON

INSTITUTO DE ASTROFÍSICA DE CANARIAS (IAC)
C/Vía Láctea S/N, 38205-San Cristóbal de La Laguna, Tenerife
www.iac.es

Prof. Rafael Rebolo López

POSITION Director

PHONE 34 922 605201

EMAIL director@iac.es

DESCRIPTION

The IAC, a worldwide reference research centre in astrophysics, is a public research Consortium comprised by the Observatorios de Canarias (OCAN) and two headquarters, in La Laguna (Tenerife) and Breña Baja (La Palma). It has a state-of-the-art Technology Division with facilities and technical staff involved in the development of the most advanced instrumentation projects for the near future. In addition, the IAC has set up IACTEC in La Laguna, a technological and business collaboration space whose mission is to develop in the Canary Islands an innovative ecosystem for the transfer of high technology between the public sector and companies, taking advantage of the scientific and technological capital of the IAC.

MAIN EQUIPMENT OR FACILITIES

- 1) Optical Laboratory: area of 160 m², divided into three clean ISO class 8 rooms and an ISO class 6 room. Equipment includes optical instruments and a wide variety of other elements.
- 2) Optical fibre Laboratory: preparation, characterization and integration of optical fibres and bundles; the lab is equipped with STRASBAUGH and ENGIS polishing machines.
- 3) Electronics and Electromagnetic compatibility Laboratories: shielded isolated room of 35 m, and electronic equipment (oscilloscopes, signal analyzers, EMI receptors, etc.).
- 4) Laboratory of Imaging and Sensors for Astronomy: calibration and characterization of visible wavelength detectors (Quantum efficiency, noise, spectral response, etc.).
- 5) Climatic chamber of 8000 liters of usable capacity, capable of simulating environments from -200C to 750C and 40% to 98% relative humidity, with 20C/minute gradient.
- 6) Mechanical Integration Laboratory: equipped with appropriated tools, precision measuring devices, and general purpose test cryostats and vacuum and cryogenic hardware.
- 7) Computer Aided Design & Engineering Laboratory: powerful hardware platforms and software to support mechanical design and analyze optical and mechanical systems.
- 8) Metrology Laboratory: 3D measuring machine with precision of a few microns, two portable coordinate measuring machines, an arm for small distances and a Laser Tracker.
- 9) Electronics Workshop: Multilayer printed circuit boards, SMDs, microcontrollers, special power supplies, racks and cables are routinely manufactured.
- 10) Mechanical Workshop: Lathes and mills with five numerically controlled high precision machines, painting enclosure, anodizing plant, shotblasting machine, furnace, and welding and cutting machines. Works on steel, stainless steel, aluminium alloys, bronze, teflon, etc.

11) Large instrument assembly, integration and verification room: With a floor area of 540 m² and 10 m high, the lab is a 100000 class cleanroom. It is divided in several areas, including an anti-vibration plate for optics, as well as a GTC Nasmyth rotator simulator.

12) Advanced Optics Systems Centre: three laboratories for optical manufacture from 10 cm to 1.5 m of diameter, including grinding, polishing, ultrapolishing and coating. Three interferometers, profilometer and a 3D scanner will be available for metrology

IACTEC comprises a purpose-built headquarters that offers businesses a space of more than 4000 m², equipped with infrastructure, including offices, meeting rooms, clean rooms, multipurpose laboratory, storage areas, computer rooms, common areas, and underground parking.

PROJECTS UNDER DEVELOPMENT

In addition to its research projects, the IAC conducts, among others, instrumental projects for space facilities (PLATO, LITEBIRD), operation and viability of telescopes (EST, ELT, OPTICON, SOLARNET), infrared instruments (HARMONI, HIRES, EMIR, MIRADAS, FRIDA, NIRPS), visible instruments (HORS, ESPRESSO, WEAVE, HARPS3), high-spatial resolution systems (GTCAO-LGS, AOLI, EDiFiSE, EST) or microwave instruments (TGI-QUIJOTE, FGI-QUIJOTE, SANCHO). Through IACTEC IAC collaborates with industry in: (1) Micro-Satellites: development of a sub-meter resolution camera (including optics and detector); (2) Medical Technology: design and assembly of a device for detection of diabetes ulcers by using thermal and microwave imaging; (3) Large Telescopes: EST, CTAO, and NRT. Other emerging lines: Quantum communications, Hi-Tech Technology Business Incubator, etc.

TECHNOLOGY CAPABILITIES

Optical system design and testing, Mechanical and opto-mechanical system design and development, Cryogenic and vacuum system design and development, Precision mechanics, Adaptive optics, Fibre optics, Control systems, Sensor characterisation, Project management, Systems, Electronic system, Software design and Laser communications.

SUMMARY OF RESEARCH SERVICES

The IAC's Technology Division, in close coordination with IACTEC, provides technology, development and production support for research and technology projects.

PROCUREMENT PROCESS

Law 9/2017, of 8 November 2017, on Public Procurement, which transposes Directives 2014/23/EU and 2014/24/EU of the European Parliament and of the Council, of 26 February 2014, into Spanish law.



Integration in the AIV room of the TGI (Thirty Gigahertz Instrument), the second instrument for the QUIJOTE Experiment, at theTeide. © Pablo López /IAC.



Integration in the AIV room of EMIR, a wide-field camera and multi-object spectrograph in the near infrared, designed and built by the IAC for the Gran Telescopio CANARIAS. © Pablo López /IAC.



HOSTING ORGANISATION
ADDRESS
WEB
CONTACT PERSON

GRAN TELESCOPIO DE CANARIAS
C/Vía Láctea S/N, 38205-San Cristóbal de La Laguna, Tenerife
www.gtc.iac.es
Dr. Romano L.M. Corradi
POSITION Director
PHONE +34 922 425720
EMAIL romano.corradi@gtc.iac.es

DESCRIPTION

The 10.4m Gran Telescopio Canarias (GTC) is currently the world's largest optical-infrared telescope. The GTC is an initiative of the Instituto de Astrofísica de Canarias, and is funded by the Spanish Administration and the Canary Islands Autonomous Community with the international participation of institutions in Mexico (UNAM and INAOE) and in the US (University of Florida). The public company Gran Telescopio de Canarias, S.A. (GRANTECAN) is responsible for its construction, operation, maintenance and development. GTC is fully operational since 2009.

MAIN EQUIPMENT OR FACILITIES

The GTC was designed to be a versatile telescope, able to simultaneously host different instruments at its multiple focal stations, whose use can be switched in few minutes. Three to six instruments, covering the optical and near infrared domains at different spectral resolution and with multiplexing capabilities, are currently installed at the telescope and routinely offered to the scientific community. Present instruments are:

OSIRIS, now located at the main Cassegrain focus of the GTC, is an imager and spectrograph for the optical wavelength range. It allows broad-band imaging and long-slit spectroscopy, as well as narrow-band imaging using tunable filters and multi-object spectroscopy (MOS). Its field of view is $7 \times 7 \text{ arcmin}^2$.

EMIR is a near-infrared camera and spectrograph equipped with several state-of-the-art high-technology subsystems, such as a cryogenic robotic system of reconfigurable slits able to simultaneously obtain spectra of 50 targets. EMIR capabilities include broad-band and narrow-band imaging, and long-slit and MOS spectroscopy over a field of view of $6.7 \times 6.7 \text{ arcmin}^2$.

MEGARA is a MOS and IFU visible spectrograph with R up to 20,000. HORuS is a R=25000 single source fibre spectrograph for the visible range (visiting instrument). HiPERCAM is a high-speed (up to 1000 Hz), multi-band (ugriz) camera (visiting instrument)

PROJECTS UNDER DEVELOPMENT

MIRADAS, a MOS near-IR spectrograph with R=20000. It is under construction at the University of Florida and expected to be mounted at the GTC during 2022.

FRIDA, a near-IR imager and IFU spectrograph (up to R=30000), which is being developed at UNAM, México. It is expected at the GTC in 2023. It will be fed by an Adaptive Optics system under development at the IAC. A laser guide system will be also implemented at a later stage.

For the list of instruments available at a given time, see www.gtc.iac.es/instruments/instrumentation.php.

Other ongoing projects are the upgrade of the GTC IT facilities and software architecture, the automatization and optimization of the operations, a strong obsolescence control, the implementation of energy-efficient and sustainable solutions in all activities, and the progressive digitalization of the whole infrastructure within an Industry 4.0 paradigm.

TECHNOLOGY CAPABILITIES

GRANTECAN has a wide expertise in the design of telescopes and their instrumentation. This includes various related technologies such as optics, mechanics, opto-mechanics, optoelectronics, visible and IR detectors and related systems, cryogenics, control systems and related software, etc.

SUMMARY OF RESEARCH SERVICES

The GTC provides advanced observing capabilities to the astronomical community. While formal partners are Spain, Mexico and the University of Florida, GTC is open to the interest of other user communities, both via scientific and technical collaborations and agreements. Along these lines, a Collaboration Agreement was signed in 2016 with the Academy of Science of China. Access to GTC observing time is done via the corresponding Time Allocation Committees. Data are obtained in service-queue mode, or in visiting mode. More information at <http://www.gtc.iac.es/observing/observing.php>

PROCUREMENT PROCESS

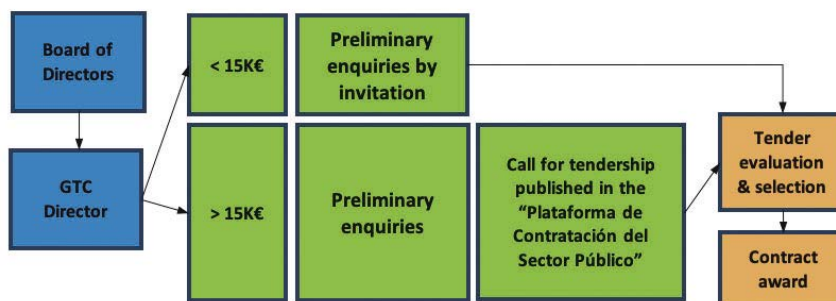

Inside view of the Gran Telescopio Canarias dome



Outside view of Gran Telescopio Canarias

**OBSERVATORY
HOSTING ORGANIZATION
ADDRESS****Observatorio del Teide
WEB
CONTACT PERSON**

OBSERVATORIOS DE CANARIAS
Instituto de Astrofísica de Canarias (IAC)
Observatorio del Roque de los Muchachos: Pico del Roque de los Muchachos, Garafía (La Palma, Spain)
Izaña (Tenerife, Spain)
www.iac.es
Prof. Rafael Rebolo
POSITION Director
PHONE 34 922 605 201 / 34 922 605 200
EMAIL director@iac.es

DESCRIPTION

The Instituto de Astrofísica de Canarias (IAC) administers this Singular Scientific and Technical Infrastructure (ICTS), formed by the Observatorio del Roque de los Muchachos (ORM), in La Palma island, and the Observatorio del Teide (OT), in Tenerife island. The excellent astronomical quality of the sky at the Canary Islands -thoroughly characterized and protected by law- makes these observatories astronomical reserves, open to the international scientific community since 1979. Currently the OCAN host telescopes and instruments belonging to more than 75 institutions from 25 countries, being the most important set of astrophysical infrastructures within the territory of the European Union (EU) for visible and infrared nocturnal and solar research, and the largest collection of multinational telescopes worldwide. Other experiments for high-energy astrophysics and the study of the cosmic microwave background complete the infrastructures available.

MAIN EQUIPMENT

ORM offers one of the most complete telescope arrays around the world. There are a number of night-time observation telescopes: GTC, WHT, TNG, NOT, INT, LT, Mercator and JKT. It also has two solar telescopes: SST and DOT, and other infrastructures like the Cherenkov telescopes, MAGIC I and II and FACT, SuperWASP, two DIMMA, SHABAR, CILBO and the ESFRI Research Infrastructure CTA-North.

OT is ideally suited for studying the sun, concentrating the best European solar telescopes: GREGOR, THEMIS, and VTT. In addition, it also has a number of night-time observation telescopes: TCS, Stella I and II, OGS, SONG, IAC80, MONS, SLOOH I and II, BRT, EarthShine, TADn, TIZON, XO, MASTER, LCOGT CILBO, EAST and TIZON. Most of them are remote or robotically operated. The OT also has a Solar Physics Laboratory with some instruments: two telescopes –QUIJOTE I and II-, GROUND BIRD and STRIP, to study the Cosmic Microwave Background Radiation and several experiments to check the sky quality: DIMMA, SHABAR, SQM-LE, AstMon.

PROJECTS UNDER DEVELOPMENT

The IAC conducts projects on the operation and viability of telescopes (EST, FDI, OGS, OPTICON), infrared (EMIR, MIRADAS, FRIDA, HARMONI, HIRES), and visible (HORUS, ESPRESSO, GREGOR, WEAVE, DESI) instrumentation, adaptive optics (GTCAO and LGS, EDiFiSE, FastCam, AOLI) or microwave (QUIJOTE). Major research infrastructures projects include CTA-North, EST and NRT among others.

TECHNOLOGY CAPABILITIES

The IAC develops much of the technology used for its research programmes in-house. The Technology Division is responsible for designing, developing and building the instruments needed for astrophysical observation. The IAC Instrumentation Area provides technology, development and production support for research and technological development projects. This area has staff who are highly qualified in the disciplines of mechanics, optics, electronics and software and have access to advanced development and production techniques. The Division is organized into Engineering and Production and structured as a matrix, with project managers coordinating the resources.

The expertise of the division includes the following areas: Optical system design and testing, Mechanical and opto-mechanical system design and development, Cryogenic and vacuum system design and development, Precision mechanics, Adaptive optics, Fibre optics, Control systems, Sensor characterisation, Project management, Systems engineering, Electronic systems, Software design and Laser communications

Requests from individuals or public or private entities outside the IAC which relate to require human or material resources administered by the IAC Instrumentation Area are managed by the OTRI office.

SUMMARY OF RESEARCH SERVICES

Under the terms of the Agreement on Cooperation in Astrophysics, Spain provides the site in return for a percentage of the available observing time at each of the telescopes or instruments. Observing time is awarded through the Time Allocation Commission (CAT), comprising a Solar Committee and a Night Time Committee.

There are different schemes to apply for observing time: ordinary calls (twice a year); Spain-Mexico GTC collaborative time; IAC-Nordic collaborative time; Director Discretionary Time; International Time Programme. Every semester, a number of nights of CAT time are available to service observations of short scientific programmes. The Service Time observations are carried out by the IAC's Support Astronomers Group and the presence of the user astronomer in the telescope is not required. The service time is available for six telescopes: WHT, INT, NOT and TNG at ORM, under CAT time, and TCS and IAC80 Telescopes at the OT, under non-CAT time.

Pure research activities at the IAC are organized into six subject areas covering most fields within Astrophysics whether theoretical, observational or instrumental. The IAC conducts projects on earth and space telescopes, high resolution, infrared instrumentation, optics and microwaves, as well as technological support.

PROCUREMENT PROCESS

Law 9/2017, of 8 November 2017, on Public Procurement, which transposes Directives 2014/23/EU and 2014/24/EU of the European Parliament and of the Council, of 26 February 2014, into Spanish law

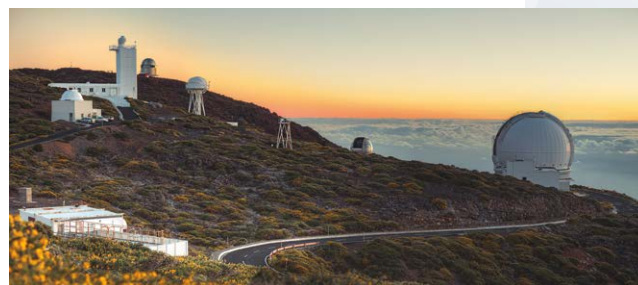



HOSTING ORGANISATION	OBSERVATORIO DE YEBES – INSTITUTO GEOGRÁFICO NACIONAL
ADDRESS	Cerro de la Palera S/N, 19141 Yebes, Guadalajara
WEB	astronomia.ign.es/web/guest/icts-yebes/
CONTACT PERSON	Pablo de Vicente Abad
	POSITION Director
	PHONE +34 949 290 311
	EMAIL pablo.devicente@oan.es

DESCRIPTION

Yebes Observatory, located in the municipality of Yebes (Guadalajara) is a research institute which belongs to the Spanish National Geographic Institute (Ministry of Movilidad, Transporte y Agenda Urbana). The Observatory is devoted to observing astronomical sources in the radio spectrum to achieve a better understanding of our Universe and our Earth as well as to developing and constructing instrumentation in the field of radio astronomy.

MAIN EQUIPMENT OR FACILITIES

1) The 40m radio telescope is a Nasmyth-Cassegrain antenna which operates in the centimetre and millimetre wave range. It is the most important observing instrument of the Observatory of Yebes and it is currently equipped with high sensitivity cryogenic dual polarization receivers which cover the following bands: 2.1-2.4 GHz, 4.5-9 GHz, 8.1-8.9 GHz, 20-26 GHz, 32-50 GHz and 72-90 GHz. The telescope works in two different modes: as a single dish telescope and as an element of several international interferometric networks like the European VLBI Network and the Global Millimeter VLBI Array. As a single dish element, it is equipped with an ultra-wide 18 GHz spectral backend, state of the art, connected to the 32-50 GHz and 72-90 GHz receivers. For the second type of observations the telescope is equipped with instrumentation that allows to record, store and transfer big volumes of data at very high speed to the correlator centers. The telescope, and the rest of the Observatory is connected at 100 Gb/s to the high velocity Spanish scientific network Rediris-NOVA.

2) The 13.2 m radio telescope of the Observatory of Yebes, is one of the most active and important elements of the VLBI Global Observing System (VGOS) within the International VLBI Service (IVS). It is also the main node of the Red Atlántica de Estaciones Geoespaciales (RAEGE) composed of 4 telescopes: Yebes, Santa María (Açores Islands), Gran Canaria in the Canary Islands (still under construction) and Flores (only projected). The telescope is specially designed to perform geodetic VLBI VGOS observations, and as such it is equipped with a high wide band receiver between 2 and 14 GHz. The data are recorded and stored locally and transferred later to the corresponding geodetic correlator.

3) Microwave and Millimeter Wave Cryogenic Laboratory. The Observatory of Yebes is a center for the development of radio astronomy devices and is considered an international reference in this area for its quality and reliability. The developments are mainly performed at these laboratories which are equipped with microwave, millimeter and cryogenic instrumentation for the characterization of microwave and millimeter components. The frequency range extends from DC to 140 GHz and the characterization of the devices is done in a wide temperature range: from ambient to cryogenic temperatures (4 K).

PROJECTS UNDER DEVELOPMENT

- ORP is a 15 M€ ERC project that manages funding for all European optical and radio telescopes. The IGN takes part in several activities related to the proposal tool and the influence and mitigation of RFI on the radio observations.
- YDALGO is 9.75 M€ EU funded (EDRF) project to build a laboratory and workshops building and an optical SLR telescope for the determination of relative positions of satellites orbiting the Earth with respect to the SLR station.
- YNART is 3.75 M€ EU funded (EDRF) project to improve the capabilities of the 40m radio telescope. It also includes the design and implementation of a software correlator for the EU-VGOS project and for the RAEGE network.
- EU-VGOS is a European project whose goal is the implementation of reliable, optimum and faster process for the analysis and exploitation of geodetic VLBI data.

TECHNOLOGY CAPABILITIES

The different facilities of Yebes infrastructure provide capabilities focused on the design, assembly and characterization of active and passive microwave and millimeter wave devices at ambient and cryogenic temperature, development of cryogenic receivers, design and characterization of antennas, microwave circuits gravity measurements and time and frequency measurements. The experience of the staff also provides a big expertise in software control and analysis.

SUMMARY OF RESEARCH SERVICES

Astronomical observations with the 40 m radio telescope in VLBI and single dish modes. Geodetic VLBI Observations with the 13.2m radio telescope and the RAEGE network. Design, assembly and characterization of microwave circuits and cryogenic receivers.

PROCUREMENT PROCESS

In accordance with Spanish Law 9/2017, November 8th, of Public Sector Contracts
<https://www.boe.es/buscar/pdf/2017/BOE-A-2017-12902-consolidado.pdf>



40 m radio telescope

HOSTING ORGANISATION
ADDRESS
WEB
CONTACT PERSON

Institut de Radioastronomie Millimétrique (IRAM)
Pico Veleta, Sierra Nevada (Granada, Spain)
www.iram-institute.org

Miguel Sánchez Portal / Rafael Bachiller

POSITION Director IRAM-Granada / Director Observatorio
Astronómico Nacional (IGN)

PHONE +34.958.805.454 / +34.91.265.3404

EMAIL msanchez@iram.es / r.bachiller@oan.es

DESCRIPTION

The Institut de Radioastronomie Millimétrique (IRAM) was founded in 1979 and is operated as a French-German-Spanish collaboration. Its partner institutions are the Centre National de la Recherche Scientifique (CNRS) in France, the Max Planck Gesellschaft (MPG) in Germany and the Instituto Geográfico Nacional (IGN) in Spain. The IGN participates with a fraction of investment and operation expenses and, in return, IGN gets a fraction of the observing time on each IRAM telescopes and a participation in Administrative and Technical Committees. The observatories are supported by the IRAM offices and laboratories in Granada and Grenoble.

IRAM operates two observatories, the NOEMA Interferometer at the Plateau de Bure (France) and the observatory at Pico Veleta located in Sierra Nevada (Granada, Spain), 2850 m high.

Partnership with national and international space research organisations includes ESA, NASA and CNES. IRAM also is a major partner in the international ALMA project, the giant radio observatory in the Chilean desert.

MAIN EQUIPMENT OR FACILITIES

The observatory at Loma de Dílar, close to Pico Veleta in Sierra Nevada hosts an open air, millimeter single-dish radio telescope of 30 m diameter with a paraboloidal main reflector. The mount is Alt-azimuth and fully steerable, made of steel on a concrete pedestal. The telescope has a homologous design and is thermally controlled and the reflector surface precision is 55 microns. The total weight of the moving parts is 800 tons. The frequency range of operation 73 to 350 GHz and the angular resolution 30 to 7.5 arcsec. Backends for continuum, spectroscopy and VLBI observations are available.

The instrumentation comprises three high-performance receivers: HERA (HEterodyne Receiver Array) is a dual-polarization heterodyne receiver comprising two arrays of 3 x 3 pixels each, with a frequency range 215 to 270 GHz and usable bandwidth four 4 GHz. EMIR (Eight Mixer Receiver) is a four-band heterodyne receiver with dual-polarization covering the range between 73 and 350 GHz. Instantaneous observation of two bands with a usable bandwidth of 16 GHz and two polarisations are possible. Finally, NIKA2 (New IRAM KID Array 2) is a dual-band camera operating with three frequency-multiplexed kilopixels arrays of Lumped Element Kinetic Inductance Detectors (LEKID) cooled at 150mK. NIKA2 is designed to observe simultaneously the intensity at 1.15 mm (260 GHz, 2 x 1140 pixel arrays -one per polarisation) and 2.0 mm (150 GHz, 1 x 616 pixel array). In addition, it allows for

polarisation observations at 1.15 mm. NIKA2 is built by an international consortium, led by the Institute Neel (Grenoble, France).

In addition to the receivers, several spectrometers are available for the heterodyne receivers: the Fast Fourier Transform Spectrometer (FTS) with 32 GHz bandwidth and 200 kHz resolution or 8 GHz bandwidth and 50 kHz resolution. The WILMA autocorrelator with 18 units of 1 GHz bandwidth and 2 MHz resolution; and the VESPA autocorrelator with a very high resolution of up to 3.3 kHz. In addition, the telescope is equipped with a Very Long Baseline Interferometry (VLBI) terminal.

PROJECTS UNDER DEVELOPMENT

IRAM is currently carrying out an ambitious upgrade of the 30m telescope in two areas: (a) modernisation of the servo-control system, including azimuth and elevation trains, subreflector control and wobbling system, and (b) improvement of the primary mirror (reflector) surface accuracy, thermal behaviour and gain-elevation curve. The activities started in 2021 and will extend well within 2023. Moreover, IRAM is currently developing new multi-beam heterodyne receivers in two bands at a wavelength of 3 mm (5 x 5 pixel) and 1 mm (7 x 7 pixel). Prototype instruments are currently in development. A 3 mm HEMT prototype is currently undergoing tests at the observatory.

TECHNOLOGY CAPABILITIES

Design of parabolae and their control systems, design and production of ultra-sensitive superconducting detectors and complex receiver systems, high-speed digital electronics and advanced data reduction software. Groups and laboratories at IRAM: Frontend team; SIS-Lab; Backend team; Mechanical workshop group; Computer group. The IRAM workshop is equipped with the latest generation of CNC lathes and milling machines and non-contact measuring microscopes.

SUMMARY OF RESEARCH SERVICES

The observing time must be obtained by international competition. Proposals for observations with the IRAM telescopes may be submitted twice per year through the Proposal Management System PMS. The submission period starts about three weeks before a deadline. Submission deadlines are currently around mid-March and mid-September each year for the Summer (01 June-30 November) and Winter (01 December-31 May) scheduling periods.

PROCUREMENT PROCESS

Main contracts are awarded by IRAM-Grenoble. Moreover, the local contracts related to the operation of the IRAM 30-m radiotelescope (both for goods and services) are awarded by IRAM-Granada. In both cases, IRAM performs as a private company subjected to the French or the Spanish law, respectively.



IRAM 30m telescope at Pico Veleta (Sierra Nevada, Spain)



HOSTING ORGANISATION	CENTRO DE ESTUDIOS DE FÍSICA DEL COSMOS DE ARAGÓN (CEFCA)
ADDRESS	Plaza San Juan, 1, Planta 2, 44001 Teruel
WEB	www.cefca.es
CONTACT PERSON	Javier Cenarro Lagunas
	POSITION Director
	PHONE +34 978 221 266
	EMAIL cenarro@cefca.es

DESCRIPTION

The Centro de Estudios de Física del Cosmos de Aragón (CEFCA) is a foundation of public interest of the Government of Aragón that was created in 2008 (i) to define and construct the Observatorio Astrofísico de Javalambre (OAJ), (ii) to implement the data center "Unidad de Procesado y Archivo de Datos" (UPAD), with capacity to provide raw, reduced and calibrated data to the whole scientific community, and (iii) to carry out and promote the scientific exploitation of the data produced by OAJ and UPAD. The main scientific topics of CEFCA focus on Galaxy Formation and Evolution and Cosmology.

More information: <http://www.cefca.es>

MAIN EQUIPMENT OR FACILITIES

- The Observatorio Astrofísico de Javalambre (OAJ), managed and operated by CEFCA.
- Unit for Processing and Data Archiving (UPAD): this data center has been designed to process and archive all the images collected by the OAJ telescopes. With capacity for 5.1 PB of storage and a total of more than 20 nodes with more than 500 cores, the UPAD provides the hardware infrastructure needed to provide raw, reduced and calibrated data on a quasi-real time basis and keep data backup.
- External Data Access Machine (EDAM): this is a system with 2 web servers (16 cores, 128 GB RAM, 28 TB storage, each server) and 2 database servers (12 cores, 256 GB RAM, 16TB storage, each server), to allow efficient access to the scientific database and sky images for the astronomical community and the general public.
- Scientific High Performance Computing system: this is a computing cluster made of 20 nodes summing up to 540 cores and more than 200TB of storage, available for scientific analysis carried out by researches at CEFCA.
- GALÁCTICA: this is a visitor center for the outreach and promotion of Astrophysics, conceived to host and operate up to nine telescopes and their domes. Three of them (of 80cm, 40cm and a solar telescope of 15cm with professional instrumentation) will be devoted to activities for the general public, schools, universities, amateur astronomy and research centers. The other six domes will be used for the hosting of external telescopes.

PROJECTS UNDER DEVELOPMENT

- CEFCA is developing several technological projects directly related with the operation

of the OAJ, such as the panoramic camera JPCam, the OAJ Global Observatory Control System, the JPCam@JST250 image quality control system, the OAJ events and alarms system, among others.

- As part of the UPAD, CEFCA is developing specific T80Cam and JPCam data pipelines, data analysis, calibration and verification tools, value added catalogues and data access tools (VO compatible), among others. In addition, the required hardware and software to allow for external data storage at the UPAD's facilities is under development.
- CEFCA is in charge of the developments in GALÁCTICA: domes and telescopes, communication and network facilities, control room and control hardware and software for the operation of the telescopes and domes. Outreach exhibition material is under CEFCA responsibility as well.
- CEFCA is involved in the development of the Baby-IAXO (an intermediate experimental stage before International Axion Observatory - IAXO).

TECHNOLOGY CAPABILITIES

CEFCA has expertise in several areas of technological development for astronomical telescopes and instrumentation: 1) Control (hardware and software), mechanics, electronics and optics; 2) Project management; 3) Assembly, integration and verification of ground-based instrumentation; 4) Software development, astronomical data processing and archiving, VO standards and services, user-friendly tools.

SUMMARY OF RESEARCH SERVICES

Access to OAJ telescopes and instrumentation. Access to raw, reduced and calibrated sky images and scientific databases to the astronomical community and general public. CEFCA has signed several collaboration agreements with national and international research institutions and consortia. External data storage service is under development.

PROCUREMENT PROCESS

EXPENSE APPROVAL															
DIRECTOR ≤ € 50 K															
BOARD PRESIDENT > € 50 K															
CIVIL WORK OUTSOURCING						SERVICE & SUPPLY OUTSOURCING									
MINOR CONTRACT	OPEN PROCEDURE			RESTRICTED PROCEDURE	NEGOTIATED PROCEDURES		OTHER PROCEDURES	MINOR CONTRACT	OPEN PROCEDURE			RESTRICTED PROCEDURE	NEGOTIATED PROCEDURES		OTHER PROCEDURES
	REGULAR PROCEDURE	SIMPLIFIED PROCEDURE	ABBREVIATED PROCEDURE		TENDER WITH NEGOTIATION	NEGOTIATED WITHOUT ADVERTISING			REGULAR PROCEDURE	SIMPLIFIED PROCEDURE	ABBREVIATED PROCEDURE		TENDER WITH NEGOTIATION	NEGOTIATED WITHOUT ADVERTISING	
< € 40 K		< € 2.000 K	< € 80 K				Competitive Dialogue Art. 172 LCSP	< € 15 K ≤ € 50 K (H+)		≤ € 100 K	< € 35 K				Competitive Dialogue Art. 172 LCSP
< 1 year					Art. 167 LCSP			< 1 year		Subjective criteria ≤ 25 % (Except Engineering and Architecture Services, ≤ 45 %)	No subjective criteria		Art. 167 LCSP		Association for innovation Art. 177 LCSP
Contracts with the same Contractor < € 40 K (exception: tender announcement)	In any case	Subjective criteria ≤ 25%	No subjective criteria	In any case	Tender announcement	Art. 168 LCSP	Association for innovation Art. 177 LCSP	Contracts with the same Contractor < € 40 K (exception: tender announcement)	In any case	Not applicable to Intellectual Services		In any case	Tender announcement	Art. 168 LCSP	Project competition (service) Art. 183 LCSP
(If applicable, Tender Announcement in PLACSP and in DOUE > € 5.548 K)						(If applicable, Tender Announcement in PLACSP and in DOUE > € 221 K)									
ADJUDICATION															
CONTRACT AWARDED															

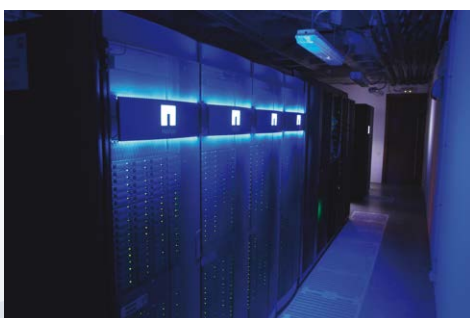

CEFCA Unit for Processing and Data Archiving (UPAD)

HOSTING ORGANISATION	OBSERVATORIO ASTROFÍSICO DE JAVALAMBRE
ADDRESS	Plaza San Juan, 1, Planta 2, 44001 Teruel
WEB	www.cefca.es
CONTACT PERSON	Antonio Marín-Franch
	POSITION OAJ Manager
	PHONE +34 978 221 266
	EMAIL amarin@cefca.es

DESCRIPTION

The Observatorio Astrofísico de Javalambre (OAJ) is an astronomical observatory built and operated by the Centro de Estudios de Física del Cosmos de Aragón (CEFCA). It is located at an altitude of 1956m within the municipality of Arcos de las Salinas (Teruel, Spain). The observatory's main purpose is the compilation of large-scale multi-filter astronomical surveys used as the basis for leading-edge research on astrophysics and cosmology.

More information: <http://oaj.cefca.es>

MAIN EQUIPMENT OR FACILITIES

The observatory is fundamentally structured around two large field-of-view, world-class optical telescopes:

- Javalambre Survey Telescope (JST250), a 2.55 m aperture, F#3.5 alt-azimuthal telescope designed to optimize image quality over the 3 degrees diameter field of view. The main scientific instrument is JPCam, a 1.2Gpixel instrument conceived to carry out the J-PAS survey.
- Javalambre Auxiliary Survey Telescope (JAST80), an 83 cm, F#4.5 telescope that provides a 2 degrees diameter field of view. The telescope is equipped with T80Cam, a panoramic CCD camera conceived to carry out the J-PLUS survey.

PROJECTS UNDER DEVELOPMENT

JPCam is a wide field, 1.2 Gpixel direct imager equipped with a mosaic of 14 9.2k-by-9.2k, 10 μ m pixel detectors plus 12 auxiliary detectors for auto-guiding and image quality control. The cryostat is actuated by a hexapod system to optimise optical alignment during operation. The instrument, that admits up to 70 filters, is starting scientific operation in 2022.

The Global Observatory Control System (GOCS) is a global tool under development to manage, monitor, control and maintain all observatory systems including, not only astronomical, but infrastructure and general facilities as well.

TECHNOLOGY CAPABILITIES

The main OAJ technology capabilities are:

- Coating facility: Composed by a coating chamber and a mirror cleaning unit. The coating chamber is a 4m diameter vacuum chamber that admits mirrors up to 3m diameter.

- Class 100.000 clean room.
- Opto-mechanical equipment: metrology equipment, spectrophotometer and reflectometer.
- OAJ has expertise in several areas of technological development for astronomical telescopes and instrumentation, such as control (hardware and software), mechanics, electronics and optics.

SUMMARY OF RESEARCH SERVICES

Open time observation projects: The OAJ offers 20% of Open Observing Time to the astronomical community through periodical calls for proposals. Detailed information can be found in <http://oajweb.cefca.es/observingtime/description>. Observations are executed in queue mode by the observatory staff. A small fraction of observing time from JAST80 is also available through the Europlanet EU Network.

Long term, legacy observation projects: CEFCA/OAJ can sign agreements with other institutions and/or consortia to carry out long term, legacy observation projects. At present, the following Memorandums of Understanding exist:

- EUCLID: Between Euclid Consortium of the European Space Agency (ESA) and CEFCA for the provision of data with JPCam to complement Euclid space telescope observations.
- J-PAS: A collaboration agreement between ON (Rio de Janeiro), IAG/USP (São Paulo), IAA-CSIC and CEFCA to carry out the J-PAS survey.

A new call for 2nd generation legacy surveys with JAST80 is open for the period 2023 – 2027.

PROCUREMENT PROCESS

The OAJ belongs to and is managed by CEFCA. Therefore, CEFCA's procurement process applies entirely to the OAJ.



The OAJ Javalambre Survey Telescope JST250



The OAJ vacuum chamber for aluminizing mirrors of up to 3m diameter





FUSION



GOBIERNO
DE ESPAÑA

MINISTERIO
DE CIENCIA
E INNOVACIÓN

Ciemat

Centro de Investigaciones
Energéticas, Medioambientales
y Tecnológicas

HOSTING ORGANIZATION
ADDRESS
WEB
CONTACT PERSON

CIEMAT-Laboratorio nacional de Fusión (LNF)
Av. Complutense 40, 28040 MADRID
www.ciemat.es
Dr. Yolanda Benito
POSITION Director General
PHONE +34 913466555
EMAIL yolanda.benito@ciemat.es

DESCRIPTION

LNF is the Spanish partner of the Eurofusion consortium, who manages the European Integrated Fusion programme. In addition to its own research in this field, LNF coordinates the work of around fifteen "linked third parties", universities, R&D centres and industries within Eurofusion.

In addition, LNF participate in experiments and developments for the international projects JET, W7X, JT60, ITER, DEMO and IFMIF (IFMIF-EVEDA and IFMIF-DONES)

MAIN EQUIPMENT OR FACILITIES

The group is presently formed by around 140 people (basically physicists, engineers and technicians). LNF operates the TJ-II stellarator facility and a number of Fusion Technology facilities. Altogether the facilities form the "LNF" ICTS (singular scientific-technical facility), included in the Spanish ICTS programme.

PROJECTS UNDER DEVELOPMENT

JET (UK, owned by the European Union). Participation in experiments, DT plasma scenarios, development of fast camera systems, development of disruption prediction algorithms

W7X (Germany). Participation in experiments, development of pellet injector and microwave reflectometer

JT60 (Japan). Design and procurement of the cryostat, participation in diagnostic developments.

ITER (France, International partnership). Work on: data archiving and visualization, visible/infrared viewing system, Collective Thomson Scattering (CTS) diagnostic system, neutronics, tritium transport calculations

DEMO (conceptual design phase). Materials (structural & functional) irradiation experiments and modelling, liquid metals (lithium, lead-lithium), breeding blankets (dual coolant), remote handling, neutronics, nuclear safety, stellarator reactor configurations, socio-economic studies (with CIEMAT Energy Department)

IFMIF-EVEDA (Japan). Accelerator components: RF system, beam diagnostics, high energy beam transmission, medium energy beam transmission, beam dump. IFMIF integrated design, medium flux irradiation cell.

IFMIF-DONES (design phase). Project leadership, project control, integrated design, accelerator components, safety. Site studies (host proposal).

TECHNOLOGY CAPABILITIES

Mechanical engineering. Finite elements calculations, CAD-CATIA design, vacuum systems, leak detection, cooling systems

Fabrication & assembly. Own workshop, limited size components

Electrical engineering. Power electronics, signal electronics, high power RF systems.

Nuclear calculations. Neutronics

Sensors: X-ray, UV, Visible, Infrared, Millimeter wave radiometry, Microwave. Fast particles.

Materials characterization: SIMS, FUB milling, nanonindenter, ductility test, optical & electrical properties

Liquid metals: lithium, lead-lithium

Data. Data management, data mining

SUMMARY OF RESEARCH SERVICES

Services related to the above technologies

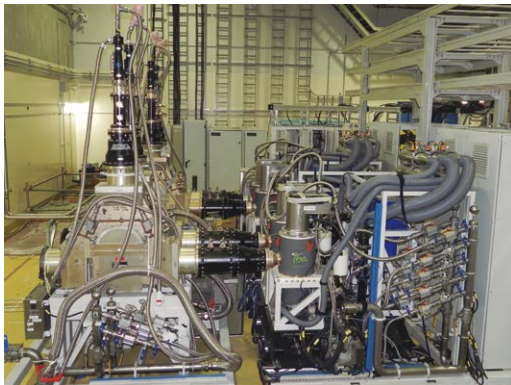

IFMIF RF System, Rokkasho, Japan

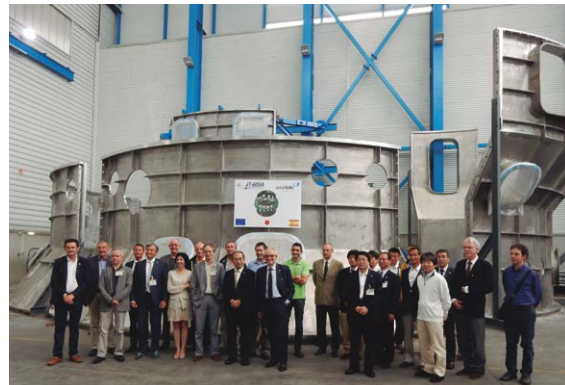

JT 60 Cryostat body, fabricated at Asturfeito, Asturias



Liquid Metals Laboratory at CIEMAT

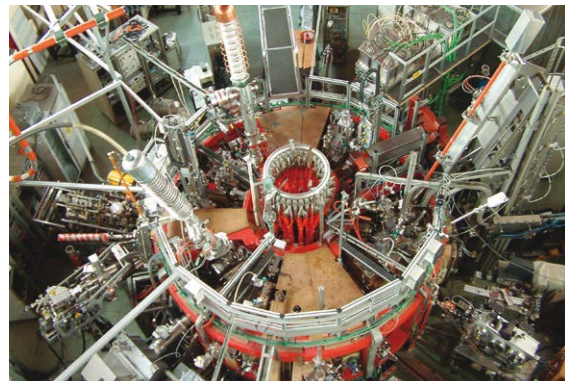

TJ-II experiment



The background is a complex, abstract composition of light blue and white geometric shapes. It features a large, semi-transparent circular arc on the left side, overlaid with a series of white lines and dots that resemble a circuit board or a particle detector layout. There are also several white triangles pointing to the right, and various other geometric forms like rectangles and circles scattered throughout. The overall aesthetic is clean, modern, and technical.

FÍSICA DE PARTÍCULAS



HOSTING ORGANISATION ADDRESS

ALBA Synchrotron
Carrer de la Llum 2-26, 08290, Cerdanyola del Valles,
Barcelona, Spain

WEB CONTACT PERSON

www.albasynchrotron.es

Alejandro Sánchez

POSITION Industrial Liaison Office Director

PHONE 00 34 935924419

EMAIL asanchez@cells.es

DESCRIPTION

ALBA Synchrotron is a Research Infrastructure based on a 3 GeV 3rd generation synchrotron facility, supporting national and international scientific communities, both academic and industrial. Presently has ten operating beamlines, four more in construction and capability for another dozen. Available techniques are dedicated to advanced matter characterization in life science and material science. It is managed by the Consortium for the Construction, Equipping and Exploitation of the Synchrotron Light Source (CELLS) which is owned 50% by the Spanish Government and 50% by regional Catalan Government.

MAIN EQUIPMENT OR FACILITIES

Structural characterization of materials: X-ray powder diffraction, both with high resolution and high pressure; X-ray magnetic dichroism; X-ray scattering and reflectivity; X-ray photoemission microscopy; X-ray angle resolved photoemission spectroscopy.

Structural characterization of bio samples: macromolecular crystallography; X-ray scattering at small and wide angle; soft X-ray cryomicroscopy and tomography, IR spectromicroscopy.

Chemical characterization of bio and material samples: X-ray absorption spectroscopy; X-ray fluorescence; IR spectromicroscopy; X-ray photoemission microscopy, including Near Ambient Pressure Photoemission.

Others: magnetic measurement laboratory; radiofrequency laboratory; vacuum laboratory; optics and metrology laboratory; electronic laboratory; bio laboratory.

PROJECTS UNDER DEVELOPMENT

ALBA upgrade to 4th generation synchrotron facility (ALBA II), including development of accelerator techniques, optics, metrology, detectors. Beamlines dedicated to protein crystallography for micro crystals, instrumentation and detector with powder diffraction and absorption spectroscopy, Fast hard X-ray tomography and radioscopy, X-ray optics metrology, Surface Spectroscopy and Structure at 1 Bar. Battery laboratory.

TECHNOLOGY CAPABILITIES

Accelerator technology (magnet, radiofrequency, vacuum, diagnostics, services, controls), IT capabilities, scientific data management, optics and metrology, mechanical engineering including high precision design and realization, civil infrastructures for high-tech research facilities, technology transfer.

SUMMARY OF RESEARCH SERVICES

Academic and industrial access to all scientific instruments and laboratories, technology transfer, innovation, scientific outreach to society

PROCUREMENT PROCESS



©Sergio Ruiz and ALBA Synchrotron

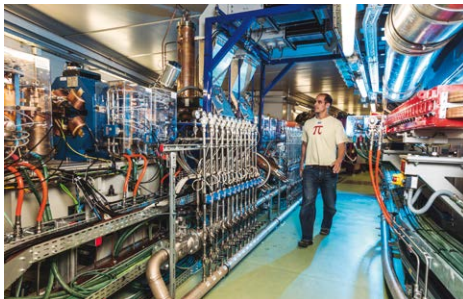

ALBA tunnel



©Sergio Ruiz and ALBA Synchrotron 1



©ALBA Synchrotron

**HOSTING ORGANISATION**

CIEMAT

ADDRESS

Avenida Complutense, 40. 28040 Madrid. Spain

WEBwww.ciemat.es**CONTACT PERSON****Luis García-Tabarés****POSITION** Head of the Electrical Engineering Division.

Dept. of Technology

PHONE +34 913 357 196**EMAIL** luis.garcia@ciemat.es**DESCRIPTION**

Public Research Center focused on energy, environment, technology and specific areas of fundamental research. Aimed at developing activity on research and development in collaboration of academic institutions and innovation within collaborative projects and contracts with industry.

MAIN EQUIPMENT OR FACILITIES

Superconducting laboratories. Magnet testing laboratories. Power Electronics, electronics and mechanical capabilities. Radiofrequency labs. Electro-mechanical Testing labs. Workshops for mechanical and electronics development.

PROJECTS UNDER DEVELOPMENT

HiLumi, FCC, EuroCirCol, iFAST, HITRI+, CLIC, UNDIGEN MAS, SMARTWEC, SEA TITAN, SPAIL, MIREDCON, Hyperloop.

TECHNOLOGY CAPABILITIES

Capabilities on the development of accelerator components for basic research sciences and social applications. Development of magnetic systems, superconducting magnets, compact accelerator design and development. Conceptual and detailed design. Dynamic studies. Power electrical systems for energy generation and storage.

SUMMARY OF RESEARCH SERVICES

Collaboration on state of the art research on accelerator technologies for scientific and social applications.



The SEA TITAN Linear Generator

Binding Process of the MCBXFA magnet for the HL-LHC

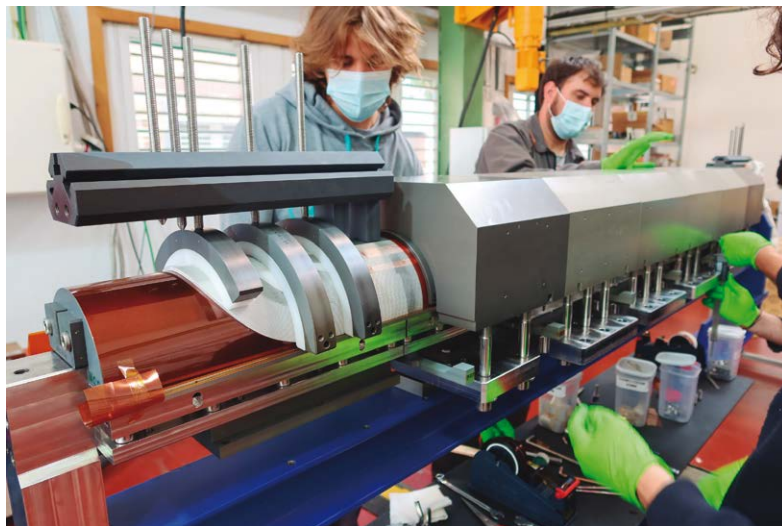

Fabrication of the MCBXFA for the HL-LHC



Facility for Testing Linear Generators for Wave Energy Conversion



ESS Bilbao

HOSTING ORGANISATION ADDRESS

ESS Bilbao
Parque Tecnológico de Bizkaia, calle Laida Bidea 207 B
semisótano 2, 48160 Derio, Vizcaya España
www.essbilbao.org

WEB CONTACT PERSON

Mario Pérez
POSITION Executive Director
PHONE 94 607 66 20
EMAIL mperez@essbilbao.org

DESCRIPTION

ESS Bilbao is a public consortium of the Spanish and Basque governments, bringing knowledge and added value in particle accelerator and neutron scattering science and technologies; by leveraging its In-Kind Contributions to the European Spallation Source ERIC, in Lund (Sweden).

MAIN EQUIPMENT OR FACILITIES

ESS Bilbao has an R&D Centre at the Bizkaia Technology Park and an Advanced Welding Facility (AWF) at Jundiz (Vitoria) hosting the support laboratories and the infrastructures developed within its in-house projects:

- Injector: composed by an Ion Source Hydrogen Positive (ISHP) – ECR type; and a LEBT (Low Energy Beam Transport) producing a pulsed proton beam at 45 KeV, 40 mA, up to 2.84 msec, 50 Hz. Other light ions production include He+, N+, O+, Ar+, Kr+, Xe+, Ne+ .
- RFQ (Radio Frequency Quadrupole): able to accelerate, bunch and focus the protons from 45KeV to 3MeV. First segment tested, 2nd,3rd and 4th segments under manufacturing.
- RF Test Stand: a fully equipped high power RF test stand, providing up to 3MW peak at 352 MHz, for testing and conditioning of RF components such as power couplers, cavities, etc.
- Integration laboratory: Covering interceptive and non-interceptive beam instrumentation, a broad range of magnets design and RF technologies for particle accelerators. Electromagnetic design and simulations, RF measurements, cavity characterization, electronics, and controls. Local protection system, machine protection system and high level integration are also included.
- Vacuum laboratory and NDTs; having all the capabilities to ensure the compatibility and correct operation of components working under Ultra High Vacuum environment (< 10-7 mbar), including vacuum gauge calibration, leak detection and outgassing testing. Also, capabilities of NDT on visual inspection, pressure testing and ongoing penetrant liquids.
- Advanced welding Facility (AWF): Electron-beam welding, vacuum brazing furnace, clean room, metrology, for specialized welding processes of different metals and ceramics and a broad range of dimensions.

PROJECTS UNDER DEVELOPMENT

ESS Bilbao is the representing entity of the Spanish Government channelling its in-kind contribution to the construction phase (2014-2025) of the European Spallation Source ERIC, in Lund (Sweden). This contribution represents the 3% of the ESS ERIC construction cost, totalling around 50 M€, and broken down in the following work packages:

- **MEBT (Medium Energy Beam Transport Line):** complete subsystem to match accelerator RFQ output and DTL tank input, including design, manufacturing and testing of cavities, magnets, diagnostics, control, assembly and integration.
- **RF Systems:** 6 complete RF Chains, 1 for RFQ and 5 for DTL tanks, composed by klystrons, modulators, loads, waveguides, interlocks and LLRF.
- **TARGET:** design, construction and testing of the following target subsystems: target wheel, drive unit and shaft; monolith vessel; proton beam window; proton beam instrumentation plug; and tuning beam dump.
- **MIRACLES INSTRUMENT:** Time-of-Flight backscattering instrument for polymer science, energy materials and magnetism studies. Prime contractors: design, manufacturing, assembly & cold commissioning.

ESS Bilbao is also actively collaborating in other projects worldwide in the realm of particle accelerators and neutron scattering science and technologies.

TECHNOLOGY CAPABILITIES

Design, prototyping, manufacturing, testing of components, subsystems and systems for particle accelerator, target and neutron instruments.

SUMMARY OF RESEARCH SERVICES

Design, prototyping, manufacturing, testing of components, subsystems and systems for particle accelerator, target and neutron instruments.

PROCUREMENT PROCESS

Public procurement procedures are conducted by ESS Bilbao according to the Spanish Law (Law 9/2017 of 8 November on public sector contracts). This policy applies to all contracts signed with regional, national and international companies. ESS Bilbao has also joined the Spanish Public Procurement Platform.

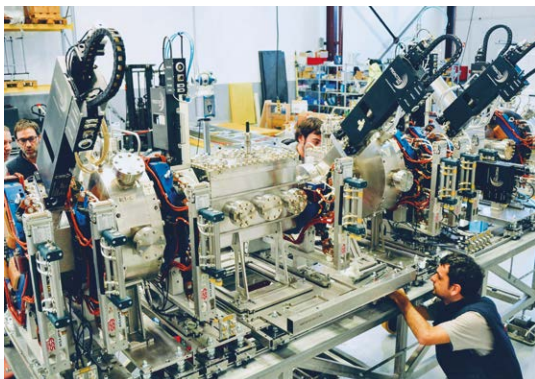

MEFT Assembly at ESS Bilbao premises



Monolith Vessel Installed in ESS ERIC



GOBIERNO
DE ESPAÑA

MINISTERIO
DE CIENCIA
E INNOVACIÓN



Link to pdf version

